

Ergebnis: 189.1 (179)
Serien: 90.3 98.8
Zähler: 9 6 2 2 0 1 0 0 0 0 0
Innenzehner: 9
Weiteste: 1311 (5.), 846 (4.), 789 (8.)
beste Teiler: 71.3 (2.), 80.4 (12.), 111.3 (14.)
Trefferkreis: 26.02 mm
Trefferlage: 0.22 mm rechts, 0.32 mm tief

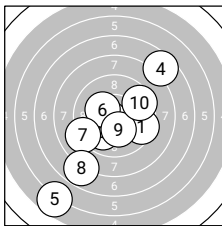
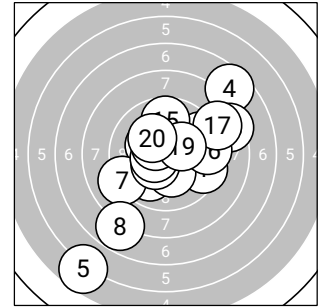

Serie 1: 90.3 (85)

9.5 →	10.7* ←	9.9 ↙	7.6 ↗	5.7 ↘
10.3* ←	9.1 ←	7.8 ↙	10.2* ↓	9.5 →

beste Teiler: 71.3 (2.), 172.7 (6.), 180.9 (9.)
Trefferkreis: 26.02 mm
Trefferlage: 0.63 mm links, 1.68 mm tief

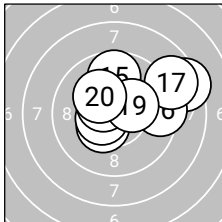

Serie 2: 98.8 (94)

10.4* ↙	10.6* ←	8.4 →	10.5* ←	9.7 ↑
9.4 →	8.8 →	10.5* ←	10.3* →	10.2* ↘

beste Teiler: 80.4 (12.), 111.3 (14.), 119.6 (18.)
Trefferkreis: 12.19 mm
Trefferlage: 1.09 mm rechts, 1.02 mm hoch



Ergebnis: 194.0 (186)
Serien: 99.9 94.1
Zähler: 11 6 2 0 1 0 0 0 0 0 0
Innenzehner: 6
Weiteste: 1110 (13.), 591 (14.), 567 (12.)
beste Teiler: 70.0 (4.), 89.1 (17.), 110.6 (16.)
Trefferkreis: 21.39 mm
Trefferlage: 0.18 mm rechts, 0.04 mm tief

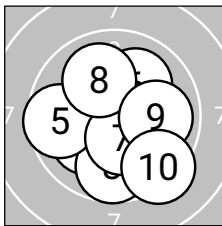
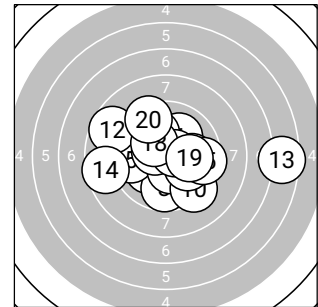

Serie 1: 99.9 (96)

10.2*←	10.1↙	9.7↓	10.7*↖	9.6←
10.0↗	10.4*↓	10.0↖	9.9→	9.3↘

beste Teiler: 70.0 (4.), 142.6 (7.), 197.6 (1.)
Trefferkreis: 11.25 mm
Trefferlage: 0.14 mm links, 0.53 mm tief

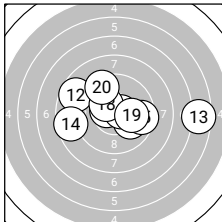

Serie 2: 94.1 (90)

10.0↘	8.7↖	6.5→	8.6←	9.5→
10.5*←	10.6*→	10.3*↖	10.0→	9.4↖

beste Teiler: 89.1 (17.), 110.6 (16.), 166.5 (18.)
Trefferkreis: 21.39 mm
Trefferlage: 0.52 mm rechts, 0.45 mm hoch



Ergebnis: **205.7** (195)
 Serien: 102.8 102.9
 Zähler: 15 5 0 0 0 0 0 0 0 0 0
 Innenzehner: 13
 Weitester: 317 (17.), 286 (10.), 263 (4.)
 beste Teiler: 44.7 (11.), 59.3 (2.), 62.1 (7.)
 Trefferkreis: 9.23 mm
 Trefferlage: 0.92 mm links, 0.15 mm hoch

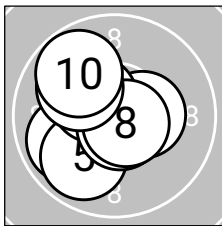
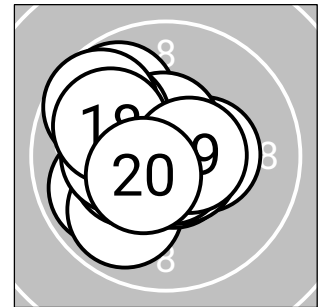

Serie 1: 102.8 (97)

10.3*↙	10.7*↘	10.4*→	9.9↙	9.9↙
10.4*↖	10.7*↘	10.7*↘	10.0↖	9.8↖

beste Teiler: 59.3 (2.), 62.1 (7.), 70.1 (8.)
 Trefferkreis: 9.12 mm
 Trefferlage: 0.71 mm links, 0.12 mm tief

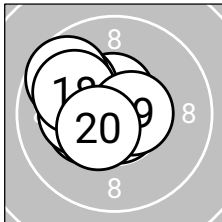

Serie 2: 102.9 (98)

10.8*↘	10.4*←	10.5*↑	10.3*←	10.2*←
9.9↖	9.7↖	10.0↖	10.6*→	10.5*↙

beste Teiler: 44.7 (11.), 91.0 (19.), 101.4 (13.)
 Trefferkreis: 8.42 mm
 Trefferlage: 1.13 mm links, 0.42 mm hoch



Ergebnis: 150.5 (143)
Serien: 69.4 81.1
Zähler: 1 4 7 2 1 2 2 1 0 0 0
Innenzehner: 0
Weiteste: 1765 (4.), 1722 (20.), 1702 (9.)
beste Teiler: 245.4 (19.), 378.8 (16.), 398.1 (15.)
Trefferkreis: 38.43 mm
Trefferlage: 2.45 mm rechts, 2.83 mm hoch

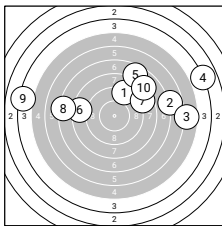
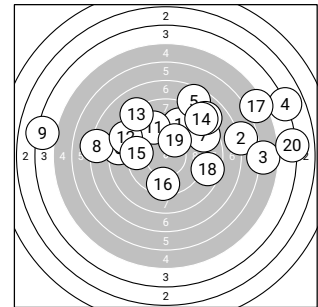

Serie 1: 69.4 (65)

9.1 ↗	6.8 →	5.7 →	3.9 →	7.6 ↗
8.4 ←	8.6 ↗	7.2 ←	4.1 ←	8.0 ↗

beste Teiler: 462.2 (1.), 585.3 (7.), 646.9 (6.)
Trefferkreis: 37.65 mm
Trefferlage: 2.32 mm rechts, 3.44 mm hoch

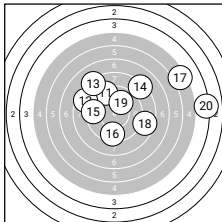

Serie 2: 81.1 (78)

9.3 ↖	8.6 ←	8.2 ↖	8.2 ↗	9.4 ←
9.4 ↓	5.3 ↗	8.6 →	10.0 ↗	4.1 →

beste Teiler: 245.4 (19.), 378.8 (16.), 398.1 (15.)
Trefferkreis: 27.10 mm
Trefferlage: 2.58 mm rechts, 2.23 mm hoch



Ergebnis: 190.9 (182)
Serien: 97.4 93.5
Zähler: 12 3 2 1 2 0 0 0 0 0 0
Innenzehner: 11
Weiteste: 1167 (10.), 1143 (12.), 761 (20.)
beste Teiler: 79.6 (17.), 97.1 (5.), 104.8 (4.)
Trefferkreis: 18.28 mm
Trefferlage: 1.98 mm links, 0.51 mm tief

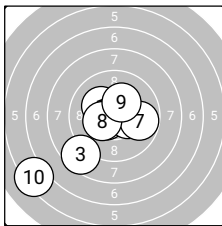
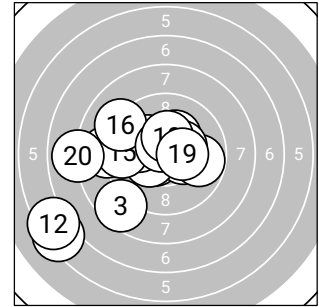

Serie 1: 97.4 (93)

10.2*↖	10.5*→	8.6↙	10.5*↙	10.6*→
10.3*→	9.8→	10.3*↙	10.3*↗	6.3↙

beste Teiler: 97.1 (5.), 104.8 (4.), 120.4 (2.)
Trefferkreis: 18.28 mm
Trefferlage: 0.97 mm links, 1.06 mm tief

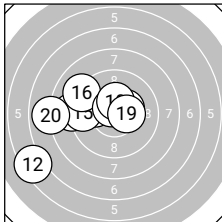

Serie 2: 93.5 (89)

8.9←	6.4↙	10.0←	10.4*↗	9.4←
9.1↖	10.6*↖	10.4*↑	10.4*→	7.9←

beste Teiler: 79.6 (17.), 144.0 (19.), 147.5 (14.)
Trefferkreis: 17.41 mm
Trefferlage: 2.99 mm links, 0.02 mm hoch



Ergebnis: 165.8 (157)
Serien: 92.5 73.3
Zähler: 4 5 4 2 2 2 1 0 0 0 0
Innenzehner: 2
Weiteste: 1690 (19.), 1340 (20.), 1302 (16.)
beste Teiler: 49.4 (10.), 171.8 (1.), 239.1 (12.)
Trefferkreis: 30.63 mm
Trefferlage: 4.55 mm links, 0.18 mm hoch

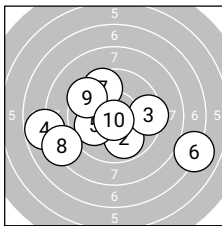
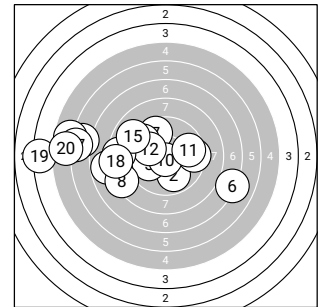

Serie 1: 92.5 (88)

10.3*←	9.9↘	9.4→	7.8←	10.0↙
7.0→	9.6↖	8.2↙	9.5↖	10.8*↓

beste Teiler: 49.4 (10.), 171.8 (1.), 248.7 (5.)
Trefferkreis: 21.40 mm
Trefferlage: 0.83 mm links, 0.74 mm tief

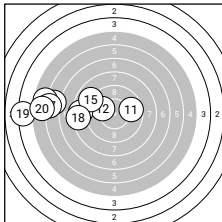

Serie 2: 73.3 (69)

9.7→	10.0↖	6.4←	8.4←	8.9↖
5.7←	6.1←	8.3←	4.2←	5.6←

beste Teiler: 239.1 (12.), 318.2 (11.), 510.0 (15.)
Trefferkreis: 24.50 mm
Trefferlage: 8.27 mm links, 1.11 mm hoch



Ergebnis: 181.2 (171)
Serien: 84.0 97.2
Zähler: 4 11 3 0 0 1 0 1 0 0 0
Innenzehner: 4
Weiteste: 1790 (4.), 1296 (5.), 748 (17.)
beste Teiler: 108.0 (11.), 146.0 (20.), 161.9 (9.)
Trefferkreis: 33.81 mm
Trefferlage: 0.63 mm rechts, 0.95 mm tief

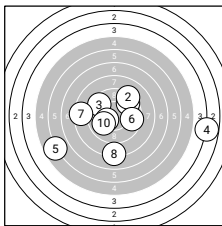
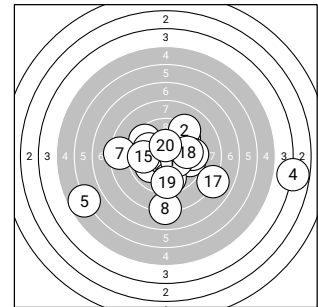

Serie 1: 84.0 (79)

9.5 ↗ 9.2 ↗ 9.5 ↖ 3.8 → 5.8 ↙
 9.6 → 8.4 ← 8.0 ↓ 10.3* ↖ 9.9 ↙

beste Teiler: 161.9 (9.), 252.1 (10.), 340.8 (6.)
Trefferkreis: 33.81 mm
Trefferlage: 0.19 mm rechts, 1.03 mm tief

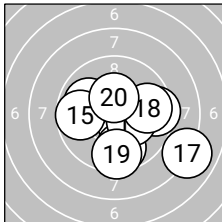

Serie 2: 97.2 (92)

10.5* ↘ 9.7 ↓ 9.5 → 9.9 ↖ 9.7 ←
 10.3* ↘ 8.0 ↘ 9.7 → 9.5 ↓ 10.4* ↑

beste Teiler: 108.0 (11.), 146.0 (20.), 167.0 (16.)
Trefferkreis: 14.78 mm
Trefferlage: 1.08 mm rechts, 0.86 mm tief



Ergebnis: 180.5 (168)
Serien: 93.2 87.3
Zähler: 3 6 7 4 0 0 0 0 0 0 0
Innenzehner: 3
Weiteste: 933 (20.), 767 (6.), 763 (18.)
beste Teiler: 75.6 (5.), 86.7 (4.), 89.3 (19.)
Trefferkreis: 19.65 mm
Trefferlage: 2.70 mm links, 0.94 mm hoch

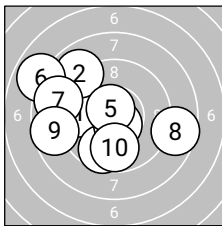
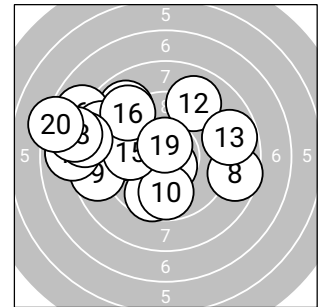

Serie 1: 93.2 (86)

9.6 ←	8.9 ↖	9.6 ↓	10.6* ↓	10.7* ↖
7.9 ↖	8.8 ←	8.6 →	8.7 ←	9.8 ↓

beste Teiler: 75.6 (5.), 86.7 (4.), 293.0 (10.)
Trefferkreis: 17.91 mm
Trefferlage: 1.96 mm links, 0.02 mm hoch

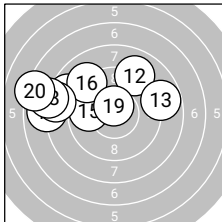

Serie 2: 87.3 (82)

7.9 ←	9.0 ↗	8.8 →	8.7 ↖	9.8 ←
9.1 ↖	8.3 ←	7.9 ←	10.6* ↑	7.2 ←

beste Teiler: 89.3 (19.), 289.5 (15.), 468.2 (16.)
Trefferkreis: 18.71 mm
Trefferlage: 3.44 mm links, 1.86 mm hoch



Ergebnis: 191.5 (183)
Serien: 92.5 99.0
Zähler: 12 3 3 1 0 1 0 0 0 0 0
Innenzehner: 11
Weiteste: 1418 (10.), 972 (6.), 738 (5.)
beste Teiler: 54.1 (8.), 65.3 (7.), 83.2 (16.)
Trefferkreis: 28.38 mm
Trefferlage: 0.87 mm rechts, 0.46 mm hoch

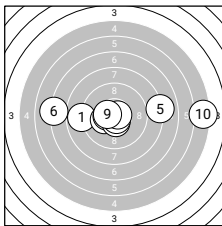
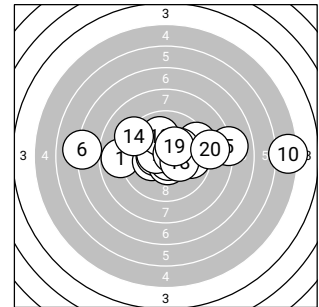

Serie 1: 92.5 (88)

8.9 ←	10.3* ←	10.5* ←	10.5* ↓	8.0 →
7.1 ←	10.7* ↓	10.7* →	10.5* ←	5.3 →

beste Teiler: 54.1 (8.), 65.3 (7.), 109.2 (4.)
Trefferkreis: 28.38 mm
Trefferlage: 0.36 mm rechts, 0.00 mm

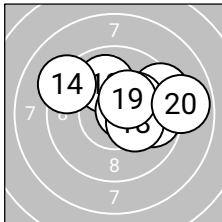

Serie 2: 99.0 (95)

9.8 →	10.2* ↗	10.0 ↗	9.2 ↖	9.4 ↗
10.6* ↗	10.2* ↗	10.3* ↗	10.4* ↗	8.9 →

beste Teiler: 83.2 (16.), 150.8 (19.), 172.5 (18.)
Trefferkreis: 13.46 mm
Trefferlage: 1.38 mm rechts, 0.92 mm hoch

Ergebnis: 196.0 (185)
Serien: 97.0 99.0
Zähler: 7 11 2 0 0 0 0 0 0 0 0
Innenzehner: 7
Weiteste: 680 (4.), 573 (8.), 429 (14.)
beste Teiler: 41.1 (9.), 116.1 (18.), 124.4 (13.)
Trefferkreis: 16.99 mm
Trefferlage: 0.29 mm links, 0.74 mm hoch

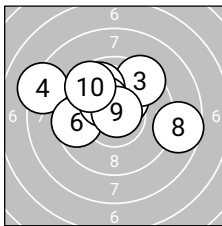
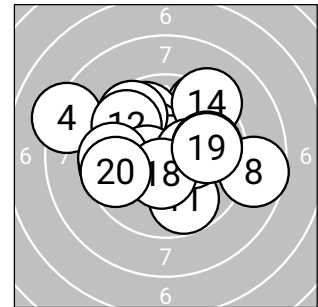

Serie 1: 97.0 (92)

10.3*↖	10.3*↗	9.4↗	8.2↖	9.8↖
9.6←	10.3*↖	8.7→	10.8*↗	9.6↖

beste Teiler: 41.1 (9.), 156.5 (1.), 158.0 (7.)
Trefferkreis: 16.99 mm
Trefferlage: 0.59 mm links, 1.36 mm hoch

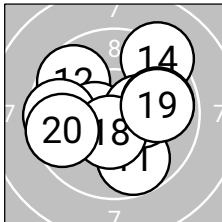

Serie 2: 99.0 (93)

9.8↘	9.7↖	10.5*←	9.2↗	9.6←
10.3*→	9.9→	10.5*↘	9.9→	9.6←

beste Teiler: 116.1 (18.), 124.4 (13.), 156.7 (16.)
Trefferkreis: 11.90 mm
Trefferlage: 0.00 mm , 0.13 mm hoch

Ergebnis: **197.0** (187)
Serien: 96.5 100.5
Zähler: 10 8 1 1 0 0 0 0 0 0 0
Innenzehner: 9
Weiteste: 955 (8.), 521 (10.), 473 (18.)
beste Teiler: 34.7 (17.), 73.3 (9.), 92.5 (3.)
Trefferkreis: 16.99 mm
Trefferlage: 0.90 mm links, 0.00 mm

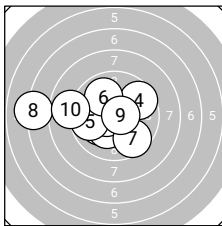
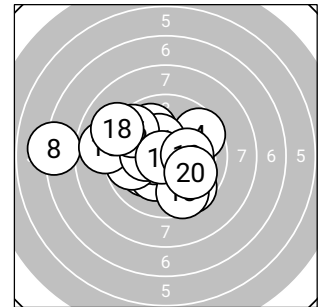

Serie 1: 96.5 (91)

10.1 ↙	10.2* ↘	10.6* ←	9.6 ↗	9.8 ←
9.9 ↘	9.6 ↘	7.1 ←	10.7* →	8.9 ←

beste Teiler: 73.3 (9.), 92.5 (3.), 180.3 (2.)
Trefferkreis: 16.99 mm
Trefferlage: 1.67 mm links, 0.07 mm tief

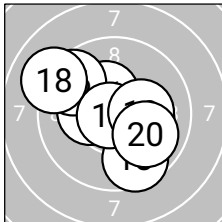

Serie 2: 100.5 (96)

10.4* ↗	10.5* →	9.6 ↘	10.3* ←	10.2* →
9.5 ↘	10.8* ←	9.1 ←	10.2* →	9.9 ↘

beste Teiler: 34.7 (17.), 108.1 (12.), 147.4 (11.)
Trefferkreis: 12.22 mm
Trefferlage: 0.13 mm links, 0.07 mm hoch



Ergebnis: 174.9 (167)
Serien: 87.1 87.8
Zähler: 3 8 4 3 2 0 0 0 0 0 0
Innenzehner: 1
Weiteste: 1040 (5.), 1001 (18.), 930 (4.)
beste Teiler: 25.0 (7.), 206.4 (13.), 232.4 (3.)
Trefferkreis: 21.95 mm
Trefferlage: 3.48 mm links, 0.09 mm tief

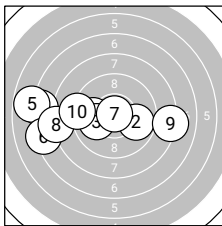
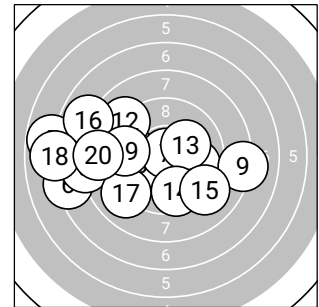

Serie 1: 87.1 (83)

9.9 ← 9.8 → 10.0 ← 7.2 ← 6.8 ←
 7.3 ← 10.9* ↑ 8.0 ← 8.1 → 9.1 ←

beste Teiler: 25.0 (7.), 232.4 (3.), 263.0 (1.)
Trefferkreis: 21.95 mm
Trefferlage: 3.54 mm links, 0.27 mm tief

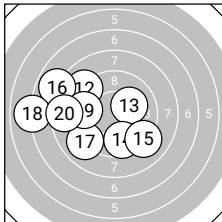

Serie 2: 87.8 (84)

8.2 ← 9.0 ↙ 10.1 → 9.6 ↓ 9.1 ↘
 7.9 ← 9.0 ↘ 6.9 ← 9.5 ← 8.5 ←

beste Teiler: 206.4 (13.), 331.6 (14.), 372.8 (19.)
Trefferkreis: 18.38 mm
Trefferlage: 3.42 mm links, 0.07 mm hoch

Ergebnis: 173.6 (167)
Serien: 89.1 84.5
Zähler: 3 9 3 3 1 1 0 0 0 0 0
Innenzehner: 2
Weiteste: 1432 (18.), 1151 (6.), 942 (11.)
beste Teiler: 110.0 (9.), 191.4 (4.), 222.4 (19.)
Trefferkreis: 22.97 mm
Trefferlage: 4.42 mm rechts, 0.32 mm tief

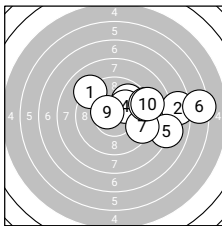
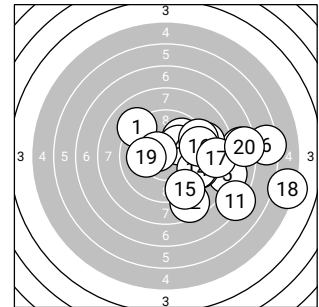

Serie 1: 89.1 (86)

9.1 ↖	7.5 →	9.9 ↗	10.2* ↗	8.0 →
6.3 →	9.3 →	9.2 →	10.5* ↖	9.1 →

beste Teiler: 110.0 (9.), 191.4 (4.), 274.2 (3.)
Trefferkreis: 19.36 mm
Trefferlage: 3.84 mm rechts, 0.90 mm hoch

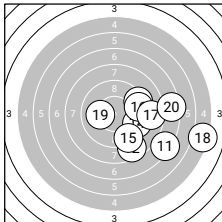

Serie 2: 84.5 (81)

7.2 ↘	8.6 ↘	9.3 ↗	9.4 →	9.2 ↘
9.4 →	8.7 →	5.2 →	10.1 ←	7.4 →

beste Teiler: 222.4 (19.), 381.8 (14.), 394.6 (16.)
Trefferkreis: 20.95 mm
Trefferlage: 5.01 mm rechts, 1.55 mm tief



Ergebnis: **198.6** (187)
 Serien: 99.2 99.4
 Zähler: 8 11 1 0 0 0 0 0 0 0 0
 Innenzehner: 7
 Weitester: 505 (9.), 479 (12.), 372 (4.)
 beste Teiler: 9.0 (11.), 57.2 (8.), 77.2 (14.)
 Trefferkreis: 12.85 mm
 Trefferlage: 1.24 mm links, 0.18 mm tief

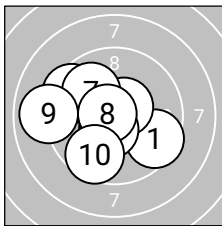
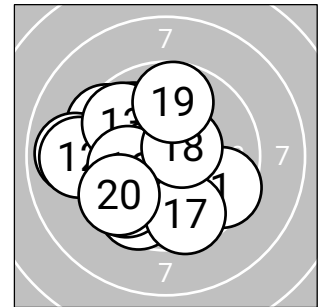

Serie 1: 99.2 (93)

9.5 ↘	10.5* ↘	9.5 ↙	9.5 ↙	10.6* ↗
10.5* ↘	9.9 ↙	10.7* ↙	8.9 ↙	9.6 ↘

beste Teiler: 57.2 (8.), 99.7 (5.), 105.5 (2.)
 Trefferkreis: 12.85 mm
 Trefferlage: 1.25 mm links, 0.04 mm tief

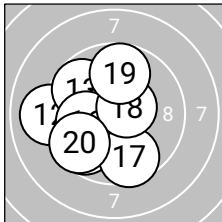

Serie 2: 99.4 (94)

10.9* →	9.0 ←	9.7 ↙	10.6* ↙	9.7 ↘
10.1 ←	9.6 ↘	10.5* →	9.7 ↑	9.6 ↘

beste Teiler: 9.0 (11.), 77.2 (14.), 102.4 (18.)
 Trefferkreis: 11.80 mm
 Trefferlage: 1.23 mm links, 0.32 mm tief

Ergebnis: **203.9** (196)
 Serien: 100.7 103.2
 Zähler: 16 4 0 0 0 0 0 0 0 0 0
 Innenzehner: 11
 Weitester: 415 (7.), 402 (8.), 337 (11.)
 beste Teiler: 29.4 (20.), 45.0 (1.), 56.6 (18.)
 Trefferkreis: 11.18 mm
 Trefferlage: 0.18 mm links, 0.24 mm tief

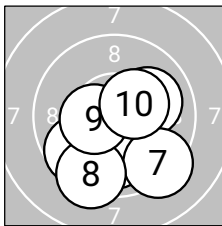
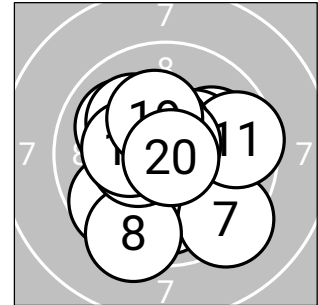

Serie 1: 100.7 (97)

10.8*↓ 10.0→ 10.7*↓ 10.0↓ 10.1↓
 9.7↙ 9.3↘ 9.3↘ 10.4*← 10.4*→
 beste Teiler: 45.0 (1.), 74.7 (3.), 131.6 (9.)
 Trefferkreis: 10.40 mm
 Trefferlage: 0.03 mm rechts, 1.31 mm tief

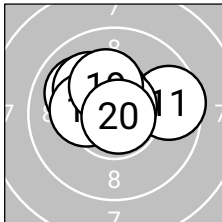

Serie 2: 103.2 (99)

9.6→ 10.0↖ 10.4*↖ 10.5*↖ 10.5*↑
 10.1↖ 10.3*← 10.7*↗ 10.3*↑ 10.8*↘
 beste Teiler: 29.4 (20.), 56.6 (18.), 114.1 (15.)
 Trefferkreis: 9.85 mm
 Trefferlage: 0.40 mm links, 0.83 mm hoch



Ergebnis: 169.7 (161)
Serien: 87.2 82.5
Zähler: 3 3 10 2 1 0 1 0 0 0 0
Innenzehner: 3
Weiteste: 1566 (14.), 1060 (5.), 802 (12.)
beste Teiler: 137.4 (4.), 192.9 (20.), 200.0 (17.)
Trefferkreis: 30.07 mm
Trefferlage: 2.80 mm links, 1.85 mm hoch

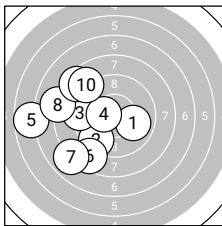
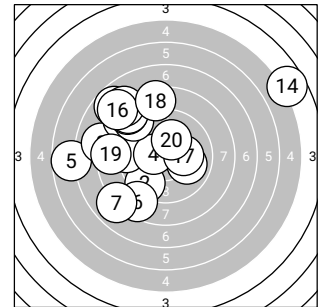

Serie 1: 87.2 (82)

9.9 ➡	9.4 ↙	9.2 ←	10.4* ←	6.7 ←
8.5 ↙	7.9 ↙	8.0 ←	8.4 ↘	8.8 ↘

beste Teiler: 137.4 (4.), 253.5 (1.), 382.2 (2.)
Trefferkreis: 17.47 mm
Trefferlage: 4.06 mm links, 0.47 mm tief

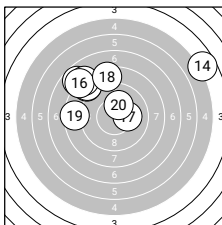

Serie 2: 82.5 (79)

8.4 ↘	7.7 ↘	8.4 ↘	4.7 ➡	8.0 ↘
8.0 ↘	10.2* ➡	8.4 ↑	8.5 ←	10.2* ↑

beste Teiler: 192.9 (20.), 200.0 (17.), 615.3 (19.)
Trefferkreis: 25.65 mm
Trefferlage: 1.54 mm links, 4.18 mm hoch

Ergebnis: **195.6 (186)**
 Serien: 97.9 97.7
 Zähler: 10 8 1 0 1 0 0 0 0 0 0
 Innenzehner: 8
 Weitester: 1056 (16.), 696 (9.), 460 (2.)
 beste Teiler: 28.8 (17.), 35.8 (8.), 71.4 (3.)
 Trefferkreis: 21.61 mm
 Trefferlage: 0.23 mm rechts, 0.44 mm hoch

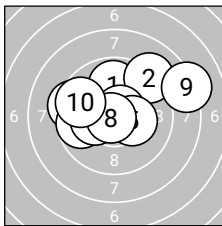
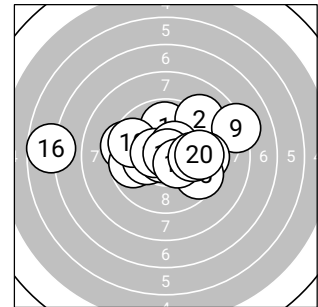

Serie 1: 97.9 (93)

9.9 ↑ 9.1 ↗ 10.7* ↗ 9.4 ← 10.3* →
 9.7 ← 10.2* ← 10.8* ← 8.2 → 9.6 ←

beste Teiler: 35.8 (8.), 71.4 (3.), 164.7 (5.)
 Trefferkreis: 14.85 mm
 Trefferlage: 0.02 mm links, 0.97 mm hoch

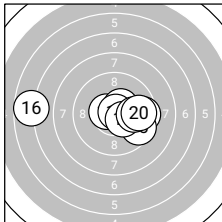

Serie 2: 97.7 (93)

10.5* ← 10.0 → 9.5 → 10.5* ↗ 9.6 →
 6.7 ← 10.8* ↗ 10.4* → 10.0 → 9.7 →

beste Teiler: 28.8 (17.), 104.8 (11.), 122.7 (14.)
 Trefferkreis: 18.66 mm
 Trefferlage: 0.50 mm rechts, 0.09 mm tief



LG 20 ZR 10min Prob

StandNr: 20

Weissbacher, Nick #70423094

Juniors_m

Wertung

StartNr: 127

08.02.2026 14:38

SG_Walchsee

Ergebnis: **183.5** (174)
Serien: 91.2 92.3
Zähler: 5 8 5 0 2 0 0 0 0 0 0
Innenzehner: 5
Weiteste: 1130 (6.), 1065 (20.), 703 (10.)
beste Teiler: 89.0 (2.), 157.6 (5.), 157.6 (19.)
Trefferkreis: 19.57 mm
Trefferlage: 2.56 mm links, 1.06 mm hoch

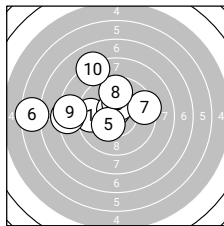
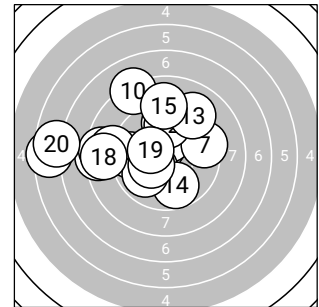

Serie 1: 91.2 (87)

9.6 ←

10.6* ↖

10.3* ↑

8.3 ←

10.3* ↙

6.4 ←

9.4 →

9.7 ↑

8.5 ←

8.1 ↖

beste Teiler: 89.0 (2.), 157.6 (5.), 165.7 (3.)
Trefferkreis: 19.57 mm
Trefferlage: 2.82 mm links, 1.26 mm hoch

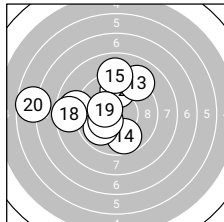

Serie 2: 92.3 (87)

8.9 ←

9.8 ↑

9.1 ↗

9.8 ↓

9.0 ↑

9.9 ↙

10.3* ↖

8.5 ←

10.3* ↖

6.7 ←

beste Teiler: 157.6 (19.), 164.3 (17.), 263.6 (16.)
Trefferkreis: 18.03 mm
Trefferlage: 2.30 mm links, 0.87 mm hoch



Ergebnis: 165.9 (159)
Serien: 81.3 84.6
Zähler: 2 9 3 3 1 0 1 1 0 0 0
Innenzehner: 0
Weiteste: 1919 (20.), 1538 (6.), 1197 (5.)
beste Teiler: 222.2 (7.), 237.6 (12.), 280.3 (18.)
Trefferkreis: 39.08 mm
Trefferlage: 1.08 mm rechts, 1.35 mm hoch

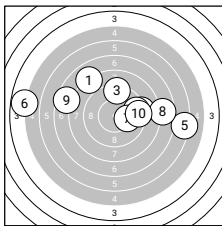
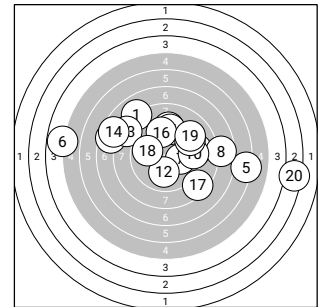

Serie 1: 81.3 (78)

8.0 ↖ 9.1 → 9.2 ↑ 9.4 → 6.2 →
 4.8 ← 10.1 → 7.7 → 7.5 ← 9.3 →

beste Teiler: 222.2 (7.), 381.5 (4.), 410.6 (10.)
Trefferkreis: 31.86 mm
Trefferlage: 0.73 mm rechts, 1.60 mm hoch

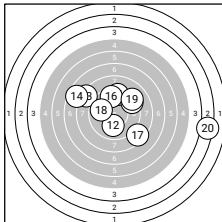

Serie 2: 84.6 (81)

9.4 ↑ 10.0 ↓ 8.2 ↖ 7.6 ↖ 9.3 ↗
 9.5 ↑ 8.4 ↘ 9.8 ← 9.1 ↗ 3.3 →

beste Teiler: 237.6 (12.), 280.3 (18.), 356.9 (16.)
Trefferkreis: 31.94 mm
Trefferlage: 1.44 mm rechts, 1.11 mm hoch



Ergebnis: 181.8 (173)
Serien: 86.9 94.9
Zähler: 6 5 7 1 0 1 0 0 0 0 0
Innenzehner: 5
Weiteste: 1432 (7.), 882 (4.), 727 (2.)
beste Teiler: 23.3 (18.), 42.0 (9.), 166.9 (14.)
Trefferkreis: 24.95 mm
Trefferlage: 0.47 mm rechts, 0.62 mm tief

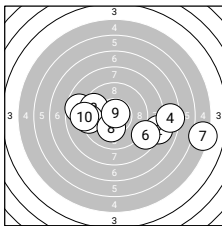
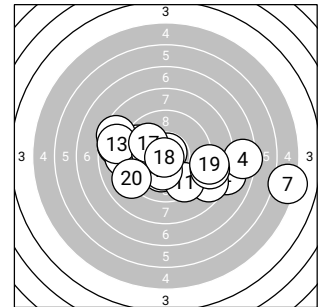

Serie 1: 86.9 (83)

8.7 ← 8.0 → 9.6 ← 7.4 → 9.3 ←
 8.6 → 5.2 → 10.2* ↓ 10.8* ↗ 9.1 ←

beste Teiler: 42.0 (9.), 191.9 (8.), 350.9 (3.)
Trefferkreis: 24.54 mm
Trefferlage: 1.66 mm rechts, 0.82 mm tief

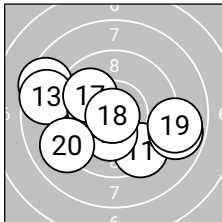

Serie 2: 94.9 (90)

9.5 ↘ 8.5 ← 8.6 ← 10.3* ↓ 10.3* ←
 8.8 → 10.0 ← 10.9* ← 8.9 → 9.1 ←

beste Teiler: 23.3 (18.), 166.9 (14.), 169.6 (15.)
Trefferkreis: 15.93 mm
Trefferlage: 0.72 mm links, 0.42 mm tief



Ergebnis: **198.3** (190)
 Serien: 100.1 98.2
 Zähler: 12 6 2 0 0 0 0 0 0 0
 Innenzehner: 8
 Weitester: 588 (13.), 527 (12.), 443 (15.)
 beste Teiler: 57.6 (4.), 70.3 (17.), 131.0 (16.)
 Trefferkreis: 12.42 mm
 Trefferlage: 1.65 mm rechts, 0.22 mm tief

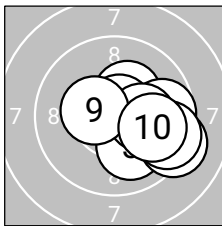
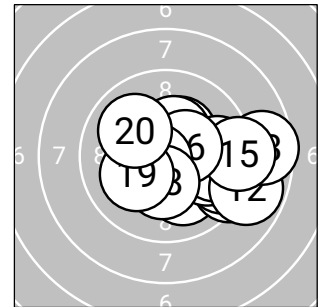

Serie 1: 100.1 (96)

10.1 →	10.3* ↗	9.7 →	10.7* ↗	10.1 ↘
9.2 ↘	9.5 ↘	10.2* →	10.4* ←	9.9 →

beste Teiler: 57.6 (4.), 135.8 (9.), 162.0 (2.)
 Trefferkreis: 10.11 mm
 Trefferlage: 1.77 mm rechts, 0.32 mm tief

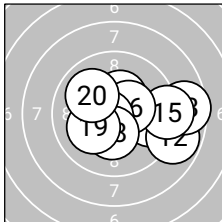

Serie 2: 98.2 (94)

9.7 →	8.8 ↘	8.6 →	10.4* ↗	9.2 →
10.4* →	10.7* ←	10.3* ↓	10.1 ←	10.0 ↙

beste Teiler: 70.3 (17.), 131.0 (16.), 148.9 (14.)
 Trefferkreis: 12.42 mm
 Trefferlage: 1.53 mm rechts, 0.13 mm tief



Ergebnis: 167.3 (158)
Serien: 84.2 83.1
Zähler: 3 8 1 3 3 1 1 0 0 0 0
Innenzehner: 2
Weiteste: 1542 (14.), 1277 (3.), 1018 (8.)
beste Teiler: 102.3 (11.), 192.9 (17.), 215.1 (6.)
Trefferkreis: 28.12 mm
Trefferlage: 1.46 mm links, 0.24 mm tief

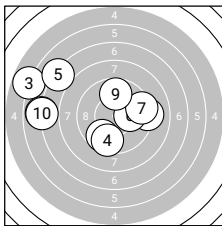
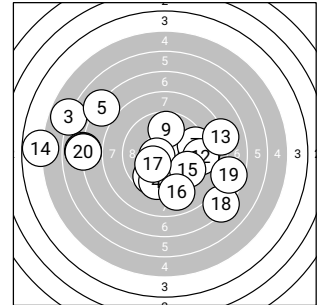

Serie 1: 84.2 (79)

9.7 ↙	9.1 →	5.8 ↖	9.5 ↓	7.1 ↘
10.1 →	9.4 →	6.9 ←	9.7 ↑	6.9 ←

beste Teiler: 215.1 (6.), 305.4 (9.), 322.9 (1.)
Trefferkreis: 21.62 mm
Trefferlage: 3.20 mm links, 0.93 mm hoch

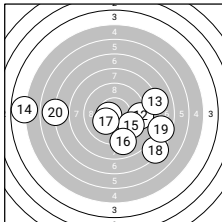

Serie 2: 83.1 (79)

10.5* ←	9.2 →	8.1 →	4.8 ←	9.6 ↘
9.0 ↓	10.2* ↙	7.2 ↘	7.6 →	6.9 ←

beste Teiler: 102.3 (11.), 192.9 (17.), 341.9 (15.)
Trefferkreis: 28.12 mm
Trefferlage: 0.26 mm rechts, 1.41 mm tief



Ergebnis: 180.2 (172)
Serien: 86.4 93.8
Zähler: 10 4 2 1 1 0 1 1 0 0 0
Innenzehner: 8
Weiteste: 1882 (10.), 1506 (14.), 1067 (3.)
beste Teiler: 89.0 (17.), 133.1 (8.), 148.7 (12.)
Trefferkreis: 38.39 mm
Trefferlage: 1.74 mm links, 0.29 mm hoch

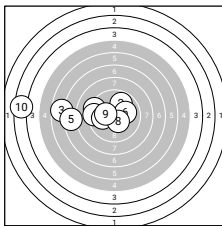
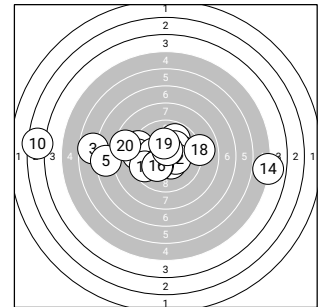

Serie 1: 86.4 (83)

9.2 ← 9.8 ↗ 6.7 ← 9.3 ← 7.4 ←
 10.0 → 10.0 ← 10.4* ↘ 10.2* ← 3.4 ←

beste Teiler: 133.1 (8.), 181.2 (9.), 231.8 (6.)
Trefferkreis: 25.48 mm
Trefferlage: 4.61 mm links, 0.59 mm hoch

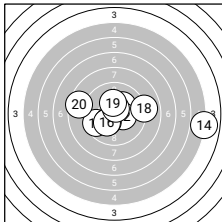

Serie 2: 93.8 (89)

10.2* ↗ 10.4* → 9.6 ← 4.9 → 10.3* ↘
 10.2* ↘ 10.6* ↑ 8.9 → 10.2* ↑ 8.5 ←

beste Teiler: 89.0 (17.), 148.7 (12.), 173.1 (15.)
Trefferkreis: 25.65 mm
Trefferlage: 1.12 mm rechts, 0.00 mm



Ergebnis: 188.2 (179)
Serien: 92.5 95.7
Zähler: 8 7 2 2 1 0 0 0 0 0 0
Innenzehner: 8
Weiteste: 1136 (10.), 959 (8.), 853 (12.)
beste Teiler: 8.0 (5.), 70.2 (1.), 129.2 (17.)
Trefferkreis: 19.83 mm
Trefferlage: 1.62 mm links, 0.83 mm hoch

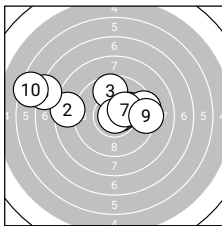
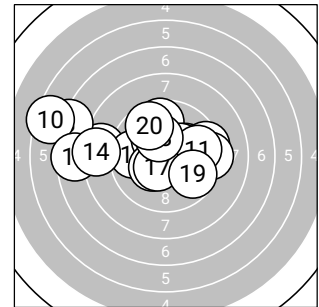

Serie 1: 92.5 (88)

10.7*➔	8.5←	9.7↑	10.2*➔	10.9*➔
9.4➔	10.3*➔	7.1←	9.3➔	6.4←

beste Teiler: 8.0 (5.), 70.2 (1.), 155.9 (7.)
Trefferkreis: 19.83 mm
Trefferlage: 1.48 mm links, 1.33 mm hoch

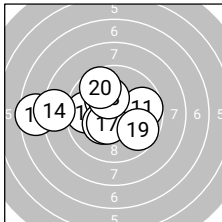

Serie 2: 95.7 (91)

9.7➔	7.5←	9.7←	8.3←	10.2*↖
10.3*↖	10.4*↖	10.2*↖	9.7↘	9.7↖

beste Teiler: 129.2 (17.), 161.8 (16.), 179.1 (15.)
Trefferkreis: 16.05 mm
Trefferlage: 1.77 mm links, 0.33 mm hoch

Ergebnis: 171.4 (165)
Serien: 87.3 84.1
Zähler: 4 8 4 2 0 1 0 0 1 0 0
Innenzehner: 2
Weiteste: 2245 (14.), 1362 (4.), 973 (1.)
beste Teiler: 63.6 (3.), 133.7 (19.), 241.0 (20.)
Trefferkreis: 32.11 mm
Trefferlage: 3.36 mm links, 1.08 mm hoch

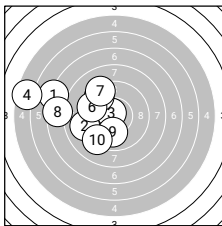
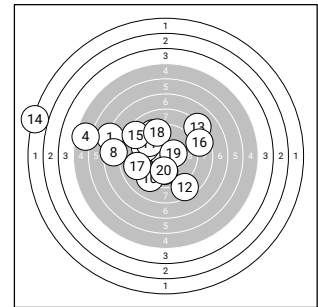

Serie 1: 87.3 (84)

7.1 ←	9.1 ←	10.7* ↗	5.5 ←	9.5 ↗
9.5 ←	9.2 ↗	7.5 ←	10.0 ↓	9.2 ↘

beste Teiler: 63.6 (3.), 247.3 (9.), 366.3 (6.)
Trefferkreis: 18.66 mm
Trefferlage: 4.67 mm links, 0.78 mm hoch

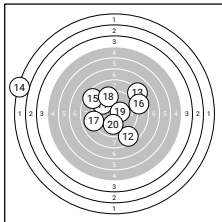

Serie 2: 84.1 (81)

9.6 ↗	8.6 ↘	8.1 ↗	2.0 ←	8.5 ↗
8.6 →	9.0 ←	9.3 ↗	10.4* →	10.0 ↓

beste Teiler: 133.7 (19.), 241.0 (20.), 347.8 (11.)
Trefferkreis: 32.11 mm
Trefferlage: 2.05 mm links, 1.39 mm hoch

Ergebnis: **186.4** (176)
 Serien: 98.3 88.1
 Zähler: 8 9 1 1 0 0 0 0 0 0 1
 Innenzehner: 7
 Weitester: 9090 (13.), 751 (10.), 515 (12.)
 beste Teiler: 43.9 (1.), 90.5 (3.), 92.3 (19.)
 Trefferkreis: 100.94 mm
 Trefferlage: 2.15 mm rechts, 3.90 mm tief

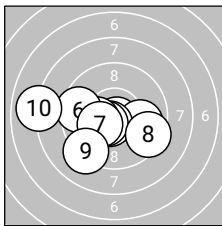
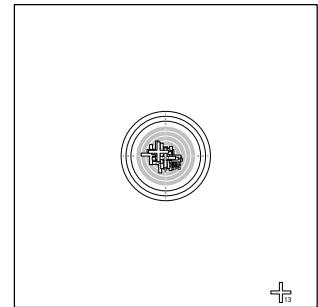

Serie 1: 98.3 (93)

10.8*↘	9.9→	10.6*↙	10.5*↙	10.2*←
9.5←	10.3*↙	9.4→	9.2↙	7.9←

beste Teiler: 43.9 (1.), 90.5 (3.), 117.9 (4.)
 Trefferkreis: 15.62 mm
 Trefferlage: 1.23 mm links, 0.77 mm tief

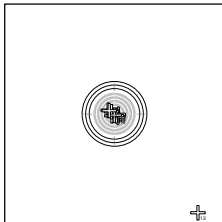

Serie 2: 88.1 (83)

9.8→	8.9↙	0.0↘	9.9→	9.6↘
10.2*↘	10.0↙	9.9↙	10.6*↓	9.2↙

beste Teiler: 92.3 (19.), 181.7 (16.), 227.2 (17.)
 Trefferkreis: 100.28 mm
 Trefferlage: 5.53 mm rechts, 7.02 mm tief

Ergebnis: 197.5 (187)
Serien: 98.5 99.0
Zähler: 9 9 2 0 0 0 0 0 0 0
Innenzehner: 7
Weiteste: 611 (13.), 536 (10.), 410 (7.)
beste Teiler: 29.1 (19.), 105.6 (11.), 112.7 (6.)
Trefferkreis: 13.77 mm
Trefferlage: 1.40 mm rechts, 0.06 mm tief

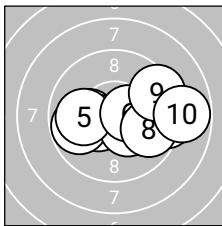
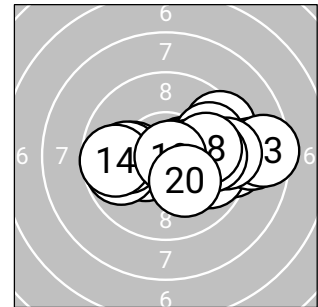

Serie 1: 98.5 (94)

10.1←	10.4*←	9.8←	10.4*↘	10.0←
10.5*→	9.3→	9.8→	9.4→	8.8→

beste Teiler: 112.7 (6.), 138.2 (2.), 144.3 (4.)
Trefferkreis: 12.70 mm
Trefferlage: 0.92 mm rechts, 0.17 mm tief

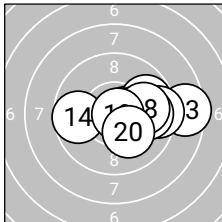

Serie 2: 99.0 (93)

10.5*→	9.8→	8.5→	9.7←	10.4*→
9.4→	9.8→	9.9→	10.8*→	10.2*↘

beste Teiler: 29.1 (19.), 105.6 (11.), 145.0 (15.)
Trefferkreis: 13.77 mm
Trefferlage: 1.88 mm rechts, 0.03 mm hoch



Ergebnis: **206.3** (197)
 Serien: 103.9 102.4
 Zähler: 17 3 0 0 0 0 0 0 0 0 0
 Innenzehner: 13
 Weitester: 292 (16.), 282 (9.), 276 (14.)
 beste Teiler: 30.0 (11.), 41.2 (4.), 61.0 (10.)
 Trefferkreis: 9.77 mm
 Trefferlage: 0.08 mm links, 0.47 mm hoch

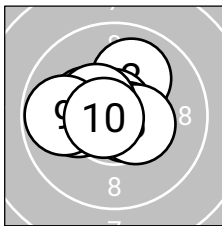
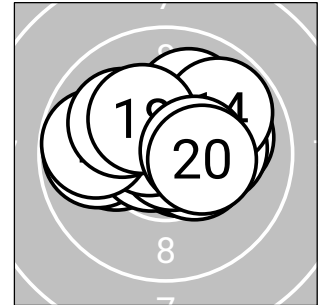

Serie 1: 103.9 (99)

10.1 ←	10.6* ↗	10.0 ↗	10.8* ↑	10.7* ↘
10.4* ↘	10.3* ←	10.5* ↖	9.8 ←	10.7* ←

beste Teiler: 41.2 (4.), 61.0 (10.), 73.3 (5.)
 Trefferkreis: 8.91 mm
 Trefferlage: 0.47 mm links, 0.32 mm hoch

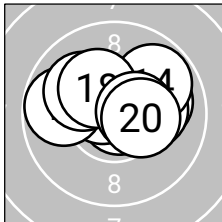

Serie 2: 102.4 (98)

10.8* →	10.0 →	10.2* →	9.8 ↗	10.6* ↖
9.8 ←	10.1 ↖	10.3* ↖	10.5* →	10.3* →

beste Teiler: 30.0 (11.), 86.2 (15.), 119.8 (19.)
 Trefferkreis: 9.72 mm
 Trefferlage: 0.29 mm rechts, 0.61 mm hoch

Ergebnis: 198.0 (191)
Serien: 97.3 100.7
Zähler: 12 7 1 0 0 0 0 0 0 0 0
Innenzehner: 8
Weiteste: 572 (9.), 480 (6.), 414 (17.)
beste Teiler: 38.2 (12.), 60.0 (4.), 76.6 (10.)
Trefferkreis: 14.17 mm
Trefferlage: 0.30 mm links, 0.21 mm tief

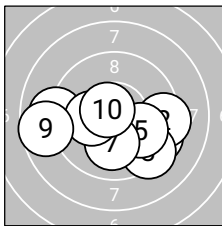
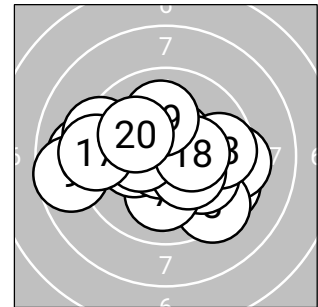

Serie 1: 97.3 (94)

9.4↗	9.3→	9.3↘	10.7*↓	10.0↘
9.0←	10.1↓	10.2*←	8.7←	10.6*↖

beste Teiler: 60.0 (4.), 76.6 (10.), 187.0 (8.)
Trefferkreis: 14.17 mm
Trefferlage: 0.08 mm links, 0.96 mm tief

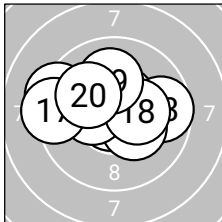

Serie 2: 100.7 (97)

10.5*↗	10.8*↘	9.7→	10.3*↘	10.4*←
9.3←	9.3←	10.3*→	10.0↑	10.1↖

beste Teiler: 38.2 (12.), 112.5 (11.), 149.5 (15.)
Trefferkreis: 11.81 mm
Trefferlage: 0.52 mm links, 0.53 mm hoch

Ergebnis: 182.9 (176)
Serien: 96.4 86.5
Zähler: 8 7 1 3 0 0 1 0 0 0 0
Innenzehner: 3
Weiteste: 1581 (12.), 987 (7.), 901 (14.)
beste Teiler: 34.0 (1.), 162.0 (16.), 182.1 (6.)
Trefferkreis: 28.09 mm
Trefferlage: 0.59 mm rechts, 0.83 mm hoch

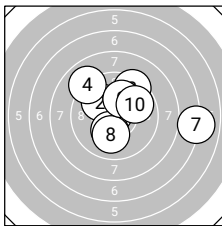
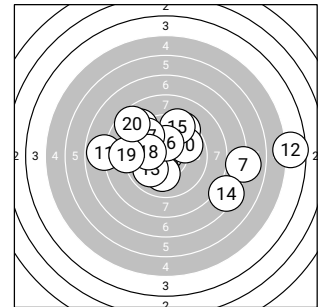

Serie 1: 96.4 (94)

10.8*↑	10.0↖	9.4↗	9.0↖	10.1↗
10.2*↓	7.0→	10.0↓	10.1↗	9.8↗

beste Teiler: 34.0 (1.), 182.1 (6.), 218.4 (5.)
Trefferkreis: 18.43 mm
Trefferlage: 1.05 mm rechts, 0.92 mm hoch

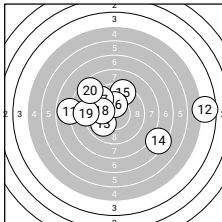

Serie 2: 86.5 (82)

7.8←	4.6→	9.9↘	7.3↘	9.4↗
10.3*↑	9.5↖	10.1←	9.0←	8.6↖

beste Teiler: 162.0 (16.), 224.6 (18.), 254.6 (13.)
Trefferkreis: 28.09 mm
Trefferlage: 0.14 mm rechts, 0.74 mm hoch



Ergebnis: 182.1 (171)
Serien: 92.4 89.7
Zähler: 3 7 8 2 0 0 0 0 0 0 0
Innenzehner: 3
Weiteste: 869 (18.), 759 (1.), 699 (15.)
beste Teiler: 76.4 (6.), 100.4 (11.), 170.8 (5.)
Trefferkreis: 18.63 mm
Trefferlage: 1.90 mm links, 1.58 mm hoch

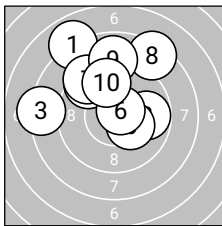
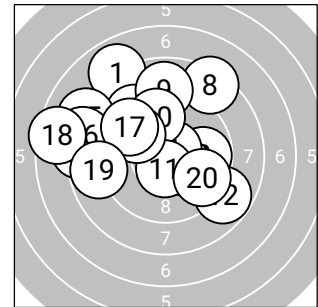

Serie 1: 92.4 (87)

7.9 ↖	9.8 →	8.2 ←	9.4 ↖	10.3* ↘
10.6* ↗	9.3 ↖	8.3 ↗	8.9 ↑	9.7 ↑

beste Teiler: 76.4 (6.), 170.8 (5.), 294.0 (2.)
Trefferkreis: 15.97 mm
Trefferlage: 0.79 mm links, 2.68 mm hoch

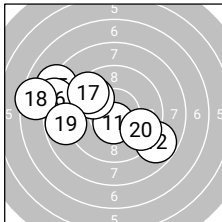

Serie 2: 89.7 (84)

10.6* ↓	8.8 ↘	9.8 ↖	8.6 ←	8.2 ↖
8.3 ←	9.5 ↖	7.5 ←	8.8 ←	9.6 ↘

beste Teiler: 100.4 (11.), 283.6 (13.), 332.7 (20.)
Trefferkreis: 18.34 mm
Trefferlage: 3.02 mm links, 0.48 mm hoch

Ergebnis: **197.0** (189)
 Serien: 98.5 98.5
 Zähler: 9 11 0 0 0 0 0 0 0 0
 Innenzehner: 4
 Weitester: 445 (5.), 391 (14.), 355 (15.)
 beste Teiler: 101.8 (18.), 128.9 (6.), 163.2 (9.)
 Trefferkreis: 11.97 mm
 Trefferlage: 1.14 mm rechts, 0.20 mm hoch

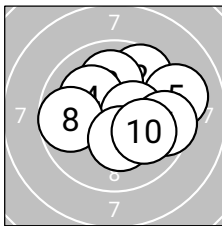
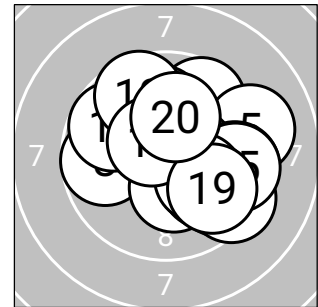

Serie 1: 98.5 (95)

9.6➔	9.7↗	10.0↑	10.1↖	9.2➔
10.4*➔	9.5➔	9.7←	10.3*↓	10.0↘

beste Teiler: 128.9 (6.), 163.2 (9.), 203.6 (4.)
 Trefferkreis: 11.97 mm
 Trefferlage: 1.15 mm rechts, 0.54 mm hoch

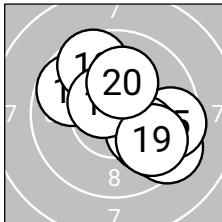

Serie 2: 98.5 (94)

9.7↖	9.7↘	9.6↖	9.4↘	9.5➔
10.0↘	10.2*↘	10.5*↖	9.8↘	10.1↑

beste Teiler: 101.8 (18.), 199.7 (17.), 202.0 (20.)
 Trefferkreis: 11.51 mm
 Trefferlage: 1.13 mm rechts, 0.13 mm tief

Ergebnis: 186.4 (175)
Serien: 93.6 92.8
Zähler: 1 13 6 0 0 0 0 0 0 0 0
Innenzehner: 1
Weiteste: 712 (10.), 563 (19.), 527 (13.)
beste Teiler: 74.6 (4.), 255.5 (16.), 268.8 (9.)
Trefferkreis: 16.40 mm
Trefferlage: 1.26 mm rechts, 2.28 mm hoch

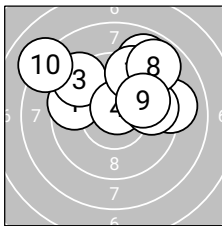
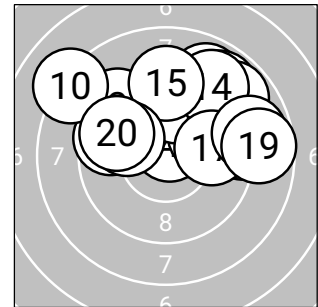

Serie 1: 93.6 (88)

9.6 ←	8.9 ↗	9.3 ↘	10.7* ↗	9.1 →
9.7 →	9.4 ↗	8.9 ↗	9.9 ↗	8.1 ↘

beste Teiler: 74.6 (4.), 268.8 (9.), 315.4 (6.)
Trefferkreis: 15.41 mm
Trefferlage: 0.54 mm rechts, 2.40 mm hoch

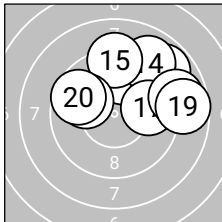

Serie 2: 92.8 (87)

9.7 ↑	9.1 →	8.8 ↗	9.0 ↗	9.2 ↑
9.9 ←	9.8 →	8.9 →	8.7 →	9.7 ↘

beste Teiler: 255.5 (16.), 281.3 (17.), 308.5 (11.)
Trefferkreis: 13.08 mm
Trefferlage: 1.97 mm rechts, 2.15 mm hoch



Ergebnis: 170.5 (162)
Serien: 92.0 78.5
Zähler: 4 7 5 0 1 1 2 0 0 0 0
Innenzehner: 2
Weiteste: 1719 (13.), 1515 (16.), 1312 (20.)
beste Teiler: 150.3 (5.), 165.4 (14.), 204.9 (19.)
Trefferkreis: 35.00 mm
Trefferlage: 1.15 mm links, 2.21 mm hoch

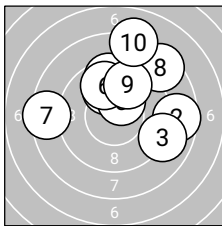
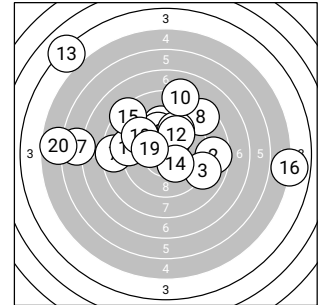

Serie 1: 92.0 (88)

10.0 ↗	8.6 →	9.0 ↘	9.5 ↑	10.4* ↗
9.8 ↗	8.4 ←	8.5 ↗	9.7 ↗	8.1 ↑

beste Teiler: 150.3 (5.), 247.6 (1.), 298.8 (6.)
Trefferkreis: 16.85 mm
Trefferlage: 0.96 mm rechts, 2.23 mm hoch

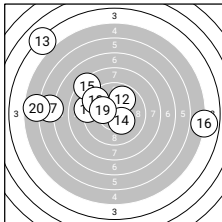

Serie 2: 78.5 (74)

9.1 ←	9.9 ↗	4.1 ↘	10.3* ↘	8.4 ↘
4.9 →	6.6 ←	9.4 ↘	10.1 ←	5.7 ←

beste Teiler: 165.4 (14.), 204.9 (19.), 272.8 (12.)
Trefferkreis: 35.00 mm
Trefferlage: 3.27 mm links, 2.20 mm hoch



Ergebnis: **191.9** (182)
 Serien: 93.8 98.1
 Zähler: 7 8 5 0 0 0 0 0 0 0
 Innenzehner: 4
 Weitester: 637 (10.), 563 (18.), 530 (2.)
 beste Teiler: 49.0 (15.), 166.4 (20.), 177.0 (1.)
 Trefferkreis: 16.24 mm
 Trefferlage: 0.11 mm rechts, 0.51 mm hoch

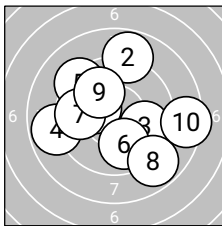
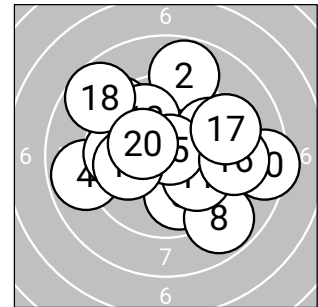

Serie 1: 93.8 (88)

10.2*←	8.8↑	9.8→	8.8←	9.3↖
9.9↓	9.7←	8.9↘	10.0↖	8.4→

beste Teiler: 177.0 (1.), 246.5 (9.), 261.2 (6.)
 Trefferkreis: 16.01 mm
 Trefferlage: 0.02 mm rechts, 0.18 mm hoch

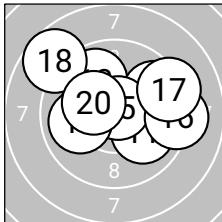

Serie 2: 98.1 (94)

10.0→	10.2*←	9.9↖	9.7→	10.8*↗
9.2→	9.3→	8.7↖	10.0←	10.3*←

beste Teiler: 49.0 (15.), 166.4 (20.), 186.0 (12.)
 Trefferkreis: 13.99 mm
 Trefferlage: 0.19 mm rechts, 0.84 mm hoch



Ergebnis: 178.7 (171)
Serien: 89.7 89.0
Zähler: 4 8 4 3 1 0 0 0 0 0 0
Innenzehner: 4
Weiteste: 1169 (8.), 934 (3.), 906 (11.)
beste Teiler: 45.0 (10.), 132.5 (9.), 185.4 (14.)
Trefferkreis: 21.40 mm
Trefferlage: 0.61 mm links, 3.39 mm tief

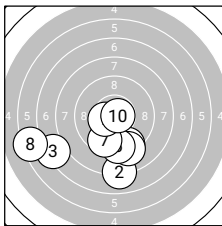
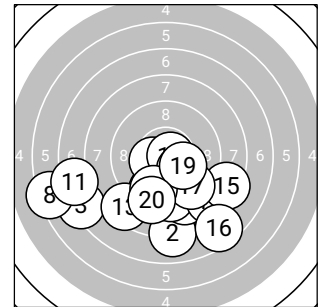

Serie 1: 89.7 (86)

9.3 ↘	8.0 ↓	7.2 ↙	9.1 ↘	9.7 ↘
9.3 ↓	9.6 ↘	6.3 ↙	10.4* ↙	10.8* →

beste Teiler: 45.0 (10.), 132.5 (9.), 311.6 (5.)
Trefferkreis: 17.40 mm
Trefferlage: 1.76 mm links, 3.43 mm tief

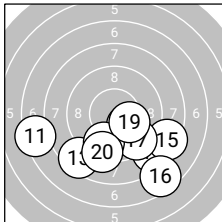

Serie 2: 89.0 (85)

7.3 ↙	8.6 ↘	8.5 ↘	10.2* ↘	8.4 ↘
7.5 ↘	9.5 ↘	9.6 ↘	10.2* ↘	9.2 ↘

beste Teiler: 185.4 (14.), 188.9 (19.), 336.9 (18.)
Trefferkreis: 19.15 mm
Trefferlage: 0.53 mm rechts, 3.36 mm tief



Ergebnis: **185.4** (178)
Serien: 96.0 89.4
Zähler: 4 11 4 1 0 0 0 0 0 0
Innenzehner: 4
Weiteste: 938 (18.), 713 (16.), 625 (19.)
beste Teiler: 75.9 (13.), 123.3 (9.), 175.5 (8.)
Trefferkreis: 18.40 mm
Trefferlage: 1.75 mm rechts, 0.95 mm tief

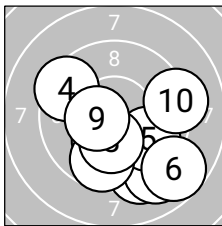
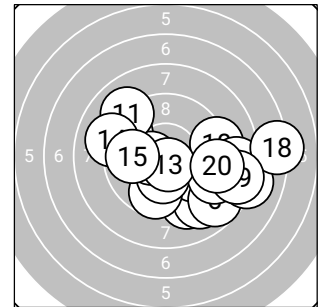

Serie 1: 96.0 (92)

9.2 ↘	9.0 ↘	10.2* ↘	9.4 ↖	9.8 ↘
8.7 ↘	9.7 ↘	10.3* ↘	10.5* ←	9.2 →

beste Teiler: 123.3 (9.), 175.5 (8.), 186.8 (3.)
Trefferkreis: 13.81 mm
Trefferlage: 0.90 mm rechts, 1.67 mm tief

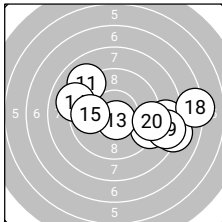

Serie 2: 89.4 (86)

9.0 ↖	9.2 ↘	10.7* ↘	9.1 ←	9.8 ←
8.1 →	8.6 →	7.2 →	8.5 →	9.2 →

beste Teiler: 75.9 (13.), 281.0 (15.), 440.0 (20.)
Trefferkreis: 18.40 mm
Trefferlage: 2.61 mm rechts, 0.23 mm tief

Ergebnis: 181.6 (175)
Serien: 94.1 87.5
Zähler: 6 6 5 3 0 0 0 0 0 0
Innenzehner: 5
Weiteste: 925 (17.), 874 (13.), 857 (19.)
beste Teiler: 101.5 (10.), 150.2 (3.), 152.0 (9.)
Trefferkreis: 21.25 mm
Trefferlage: 2.07 mm links, 1.02 mm tief

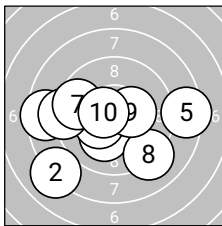
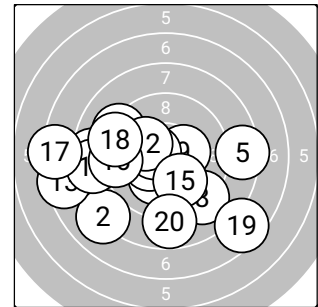

Serie 1: 94.1 (91)

10.2*↘	8.0↙	10.4*↙	8.5←	8.4→
9.1←	9.6←	9.1↘	10.3*→	10.5*←

beste Teiler: 101.5 (10.), 150.2 (3.), 152.0 (9.)
Trefferkreis: 17.45 mm
Trefferlage: 1.14 mm links, 0.87 mm tief

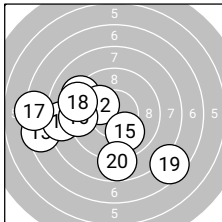

Serie 2: 87.5 (84)

9.2↙	10.2*↙	7.5←	8.5←	10.0↘
9.3←	7.3←	9.2↙	7.5↘	8.8↓

beste Teiler: 196.5 (12.), 237.5 (15.), 419.4 (16.)
Trefferkreis: 21.25 mm
Trefferlage: 2.99 mm links, 1.17 mm tief



Ergebnis: 192.2 (184)
Serien: 95.0 97.2
Zähler: 8 9 2 1 0 0 0 0 0 0
Innenzehner: 4
Weiteste: 843 (2.), 617 (12.), 571 (8.)
beste Teiler: 38.9 (1.), 89.2 (9.), 90.3 (11.)
Trefferkreis: 18.64 mm
Trefferlage: 1.24 mm rechts, 0.96 mm hoch

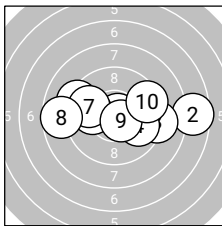
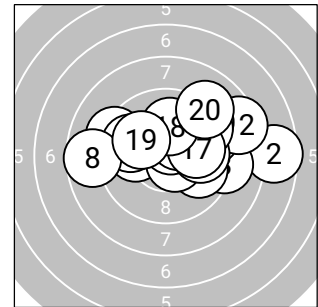

Serie 1: 95.0 (90)

10.8*➔	7.6➔	9.1➔	9.8➔	10.0←
9.2←	9.8←	8.7←	10.6*➔	9.4➔

beste Teiler: 38.9 (1.), 89.2 (9.), 236.3 (5.)
Trefferkreis: 18.64 mm
Trefferlage: 0.53 mm rechts, 0.23 mm hoch

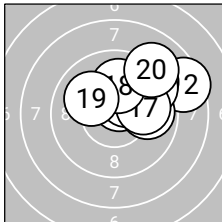

Serie 2: 97.2 (94)

10.6*↗	8.5➔	9.9➔	9.3↗	9.5↗
10.3*↗	10.0➔	10.0↑	10.0↖	9.1↗

beste Teiler: 90.3 (11.), 151.7 (16.), 228.2 (19.)
Trefferkreis: 12.19 mm
Trefferlage: 1.96 mm rechts, 1.70 mm hoch

Ergebnis: 196.4 (188)
Serien: 98.3 98.1
Zähler: 10 8 2 0 0 0 0 0 0 0 0
Innenzehner: 8
Weiteste: 744 (15.), 542 (8.), 411 (19.)
beste Teiler: 79.2 (6.), 108.6 (16.), 113.6 (10.)
Trefferkreis: 17.27 mm
Trefferlage: 0.23 mm rechts, 0.92 mm tief

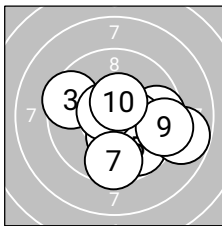
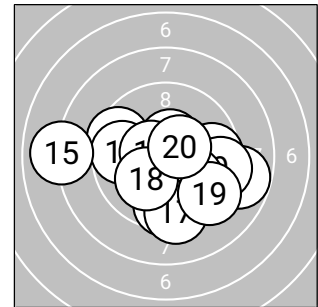

Serie 1: 98.3 (93)

9.6 → 10.3* → 9.5 ← 10.3* ↓ 9.7 ↘
 10.6* ← 9.6 ↓ 8.8 → 9.4 → 10.5* ↑
beste Teiler: 79.2 (6.), 113.6 (10.), 159.8 (2.)
Trefferkreis: 13.54 mm
Trefferlage: 1.19 mm rechts, 0.75 mm tief

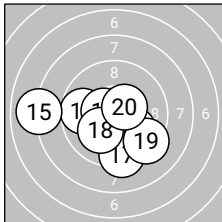

Serie 2: 98.1 (95)

10.3* ↙ 10.0 ↘ 10.4* ↓ 9.7 ← 8.0 ←
 10.5* ← 9.3 ↓ 10.1 ↙ 9.3 ↘ 10.5* ↗
beste Teiler: 108.6 (16.), 118.9 (20.), 127.6 (13.)
Trefferkreis: 15.45 mm
Trefferlage: 0.72 mm links, 1.09 mm tief



Ergebnis: 171.8 (162)
Serien: 84.5 87.3
Zähler: 2 7 6 2 2 1 0 0 0 0 0
Innenzehner: 2
Weiteste: 1468 (5.), 1230 (12.), 1190 (7.)
beste Teiler: 44.5 (19.), 82.0 (13.), 271.0 (15.)
Trefferkreis: 30.28 mm
Trefferlage: 1.43 mm links, 1.48 mm tief

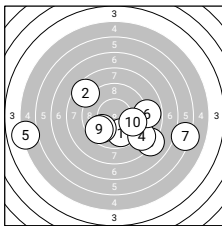
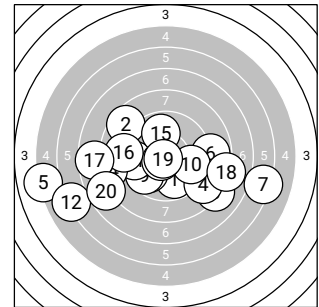

Serie 1: 84.5 (79)

9.8 ↘	8.6 ↖	8.1 ↗	8.8 ↗	5.1 ←
8.8 →	6.2 →	9.8 ↙	9.6 ↙	9.7 →

beste Teiler: 283.5 (8.), 289.2 (1.), 312.1 (10.)
Trefferkreis: 30.28 mm
Trefferlage: 0.73 mm rechts, 1.78 mm tief

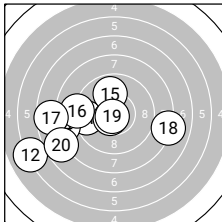

Serie 2: 87.3 (83)

9.5 ←	6.0 ←	10.6* ↙	8.2 ←	9.9 ↑
9.0 ←	7.6 ←	8.0 →	10.8* ↙	7.7 ↙

beste Teiler: 44.5 (19.), 82.0 (13.), 271.0 (15.)
Trefferkreis: 22.98 mm
Trefferlage: 3.60 mm links, 1.19 mm tief

