

Ergebnis: **248** (269.1)

Wertung: 248 Serien: 37 21 37 30 28 37 31 27

Zähler: 2 3 6 7 8 5 4 5 0 0 0

Innenzehner: 1

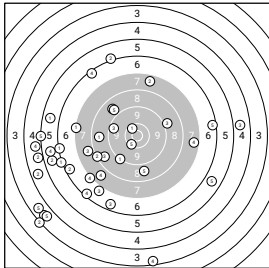

Wertung

Wertung

| | | | | | |
|-----------------|----------------|--------------|--------------|--------------|---------------|
| Serie 1: | 10.4* [3.14] ↖ | 7.6 [4.07] ↑ | 7.9 [5.02] ← | 7.2 [5.70] ↙ | 6.4 [6.45] → |
| Serie 2: | 3.7 [2.97] ↙ | 3.2 [3.71] ↘ | 9.5 [4.44] ← | 3.5 [5.45] ↓ | 3.7 [6.77] ↘ |
| Serie 3: | 8.7 [3.92] ← | 6.1 [4.93] ↑ | 8.8 [5.70] ↖ | 7.6 [6.77] → | 8.8 [7.31] ↓ |
| Serie 4: | 6.3 [2.85] ← | 5.7 [3.77] ← | 9.0 [4.57] → | 5.7 [5.42] ← | 5.2 [6.15] ← |
| Serie 5: | 5.7 [2.91] ← | 6.5 [3.78] ← | 8.7 [4.77] ↙ | 4.9 [5.75] ← | 5.8 [7.60] ↘ |
| Serie 6: | 6.2 [3.04] ← | 8.3 [4.21] ← | 7.0 [4.91] ↙ | 6.4 [5.63] ↘ | 10.3 [6.39] ↘ |
| Serie 7: | 9.2 [2.48] ↙ | 4.9 [3.18] ← | 4.8 [5.12] → | 6.4 [6.01] ↖ | 8.9 [6.81] ↖ |
| Serie 8: | 7.3 [3.19] ← | 4.6 [4.17] ← | 6.6 [5.57] ↙ | 7.8 [6.34] ↘ | 3.8 [7.07] ↘ |

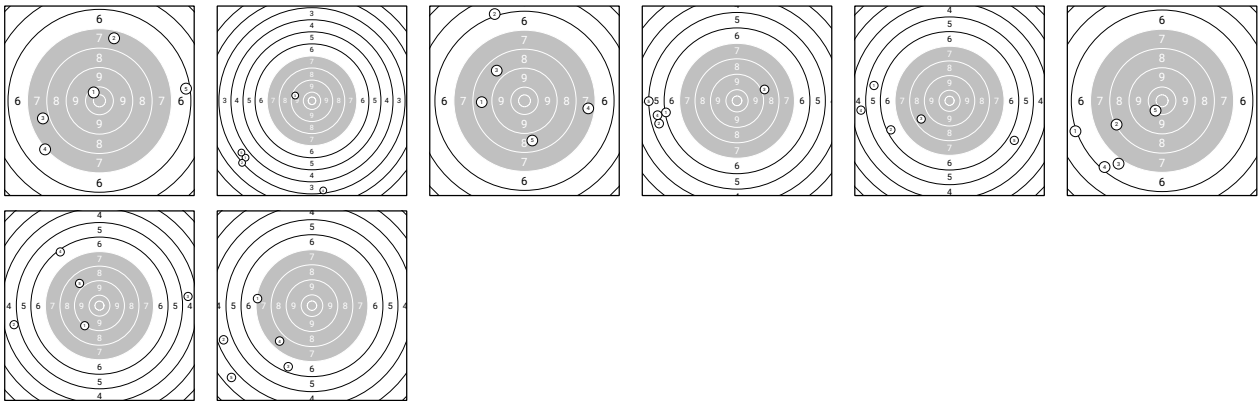

Ergebnis: **273** (288.6)

Wertung: 273 Serien: 29 34 39 35 34 34 39 29

Zähler: 1 8 4 10 7 8 1 1 0 0 0

Innenzehner: 0

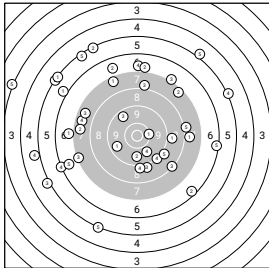

Wertung

Wertung

| | | | | | |
|-----------------|---------------|--------------|--------------|--------------|--------------|
| Serie 1: | 7.0 [3.29] ← | 5.3 [4.58] ↖ | 7.2 [6.33] ↗ | 7.7 [7.34] ← | 3.2 [7.83] ↖ |
| Serie 2: | 7.9 [1.95] → | 6.5 [3.78] ↘ | 7.7 [4.51] ← | 6.9 [5.80] ↑ | 8.1 [6.78] → |
| Serie 3: | 9.6 [3.42] ← | 7.5 [4.57] ↗ | 9.6 [5.88] ↖ | 9.9 [6.94] ↘ | 5.0 [8.14] ↗ |
| Serie 4: | 6.0 [3.97] ↖ | 6.8 [5.13] ↗ | 8.0 [5.80] ↑ | 9.2 [7.03] ↘ | 6.3 [8.03] → |
| Serie 5: | 7.5 [3.13] ↗ | 7.6 [5.62] ← | 9.0 [6.41] ↘ | 6.2 [7.14] ← | 5.4 [7.89] ↖ |
| Serie 6: | 5.3 [4.45] ↖ | 7.0 [5.61] ↑ | 7.3 [6.20] ← | 9.1 [7.26] ↓ | 6.7 [8.67] ← |
| Serie 7: | 8.9 [4.46] → | 9.8 [5.17] ↓ | 8.3 [6.42] ↘ | 5.2 [7.74] → | 9.1 [8.28] ↘ |
| Serie 8: | 10.3 [4.42] → | 5.3 [5.91] ↖ | 5.1 [7.21] ← | 4.9 [7.67] ← | 5.2 [8.24] ↘ |

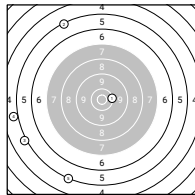
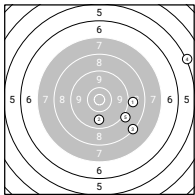
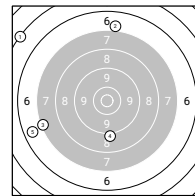
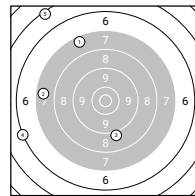
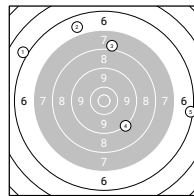
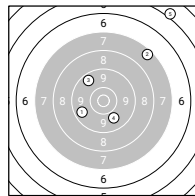
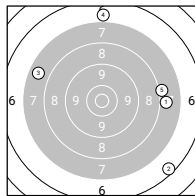
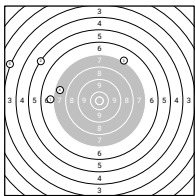

Ergebnis: **349** (368.7)

Wertung: 349 Serien: 43 48 43 43 45 42 43 42

Zähler: 9 14 14 3 0 0 0 0 0 0 0

Innenzehner: 2

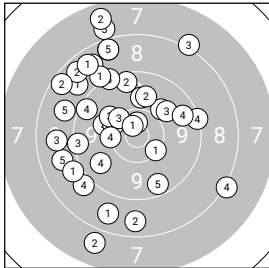

Wertung

Wertung

| | | | | | |
|-----------------|----------------|--------------|---------------|---------------|--------------|
| Serie 1: | 8.8 [3.29] ↘ | 8.6 [4.23] ↘ | 10.0 [5.32] ↙ | 9.0 [6.50] ↙ | 8.7 [7.62] ↘ |
| Serie 2: | 10.3 [2.94] ↗ | 9.5 [4.03] ↑ | 10.0 [5.29] ↗ | 10.2 [6.39] ↙ | 9.3 [7.50] ↘ |
| Serie 3: | 9.1 [3.40] ↘ | 8.7 [4.70] ↓ | 9.3 [5.67] ↙ | 8.2 [6.81] ↗ | 9.9 [8.07] ↑ |
| Serie 4: | 8.6 [3.30] ↘ | 8.5 [4.39] ↗ | 10.1 [5.80] ↘ | 9.7 [6.94] ↙ | 8.8 [8.09] ↙ |
| Serie 5: | 10.6* [3.51] ↑ | 9.9 [4.71] ↑ | 10.3 [5.89] ↘ | 9.3 [6.98] → | 7.9 [8.26] ↗ |
| Serie 6: | 8.7 [3.53] ↘ | 7.9 [4.76] ↘ | 9.9 [5.89] ↗ | 9.6 [7.38] → | 9.5 [8.56] ↘ |
| Serie 7: | 10.7* [3.49] ↗ | 8.5 [4.68] ↘ | 8.8 [5.98] ↙ | 9.4 [7.05] ↙ | 8.5 [8.87] ↗ |
| Serie 8: | 9.0 [3.12] ↙ | 7.7 [4.36] ↗ | 8.1 [5.66] ↗ | 10.2 [6.94] ↙ | 8.9 [8.20] ↙ |

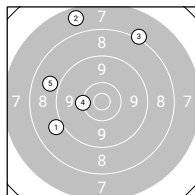
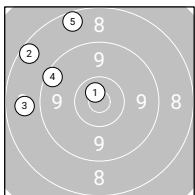
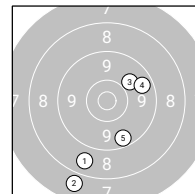
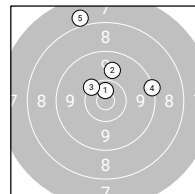
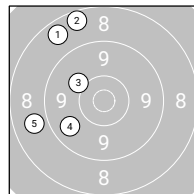
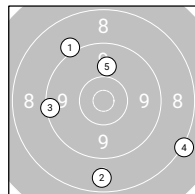
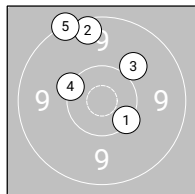
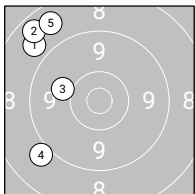

Ergebnis: **337** (355.8)

Wertung: 337 Serien: 45 44 38 40 45 44 44 37

Zähler: 8 12 13 5 0 2 0 0 0 0 0

Innenzehner: 4

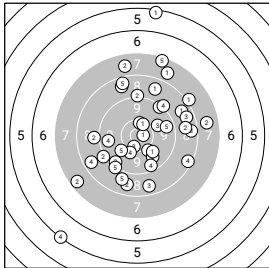

Wertung

Wertung

| | | | | | |
|-----------------|----------------|--------------|----------------|---------------|----------------|
| Serie 1: | 8.7 [3.50] ↗ | 9.2 [4.34] ↑ | 9.4 [5.08] ↘ | 10.1 [5.95] ↘ | 9.8 [6.86] ↘ |
| Serie 2: | 8.7 [3.37] ↗ | 9.0 [4.83] ← | 9.3 [5.74] ↗ | 8.6 [6.37] ↙ | 10.4* [7.21] ↑ |
| Serie 3: | 8.1 [3.47] ↗ | 8.7 [4.33] ↘ | 8.5 [5.38] → | 5.3 [6.02] ↘ | 9.2 [7.00] ↘ |
| Serie 4: | 7.8 [3.06] ↗ | 7.8 [4.05] → | 10.4* [4.76] ↘ | 8.4 [5.94] ↘ | 8.9 [6.83] ↘ |
| Serie 5: | 10.0 [3.47] ↘ | 7.8 [4.53] ↑ | 9.9 [5.59] ↗ | 10.1 [6.69] ↘ | 9.6 [7.67] → |
| Serie 6: | 10.7* [4.28] → | 7.6 [5.26] ↘ | 8.6 [6.00] ↑ | 9.2 [6.80] ↗ | 10.0 [7.49] ↘ |
| Serie 7: | 10.4* [3.54] ↗ | 9.2 [4.53] ↙ | 8.6 [5.61] → | 9.6 [6.39] ← | 8.5 [7.41] ↑ |
| Serie 8: | 5.4 [3.81] ↑ | 8.8 [5.56] → | 8.6 [6.26] ↘ | 9.5 [6.99] ↘ | 7.4 [7.96] ↗ |

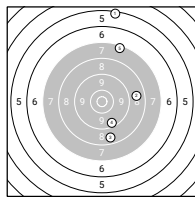
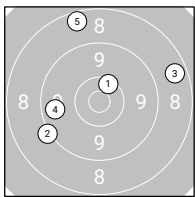
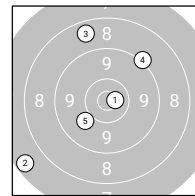
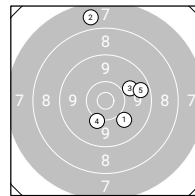
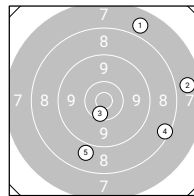
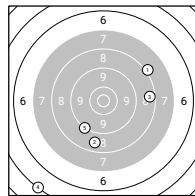
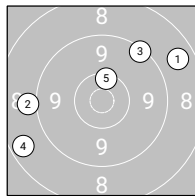
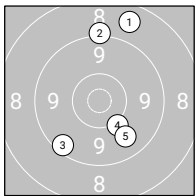

Ergebnis: **360** (376.4)

Wertung: 360 Serien: 44 42 43 47 45 45 49 45

Zähler: 13 17 7 3 0 0 0 0 0 0 0

Innenzehner: 5

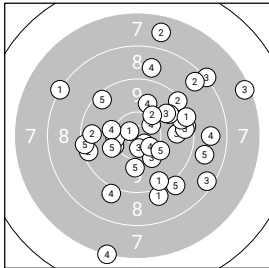

Wertung

Wertung

| | | | | | |
|-----------------|----------------|---------------|----------------|----------------|---------------|
| Serie 1: | 9.0 [3.64] ↓ | 9.4 [4.92] → | 9.7 [5.97] → | 9.0 [6.95] ↓ | 8.8 [7.81] → |
| Serie 2: | 8.2 [3.68] ← | 9.4 [5.24] ← | 8.2 [6.05] → | 8.7 [6.77] → | 9.5 [7.49] → |
| Serie 3: | 10.2 [3.89] ← | 9.3 [5.26] → | 7.4 [6.40] → | 7.2 [7.41] ↓ | 10.0 [8.35] ↓ |
| Serie 4: | 9.5 [3.84] → | 10.3 [5.02] ← | 10.6* [6.20] ↓ | 9.9 [7.43] ↑ | 9.3 [8.72] ← |
| Serie 5: | 9.8 [4.38] → | 7.7 [5.78] ↑ | 10.6* [6.81] ↓ | 10.4* [7.68] → | 9.4 [8.67] ← |
| Serie 6: | 10.7* [3.73] ← | 9.6 [5.36] ← | 9.8 [6.72] → | 8.9 [7.91] ↑ | 9.0 [9.45] ↓ |
| Serie 7: | 9.4 [3.81] ↓ | 10.2 [5.39] → | 10.1 [6.72] ↓ | 10.2 [7.66] ← | 10.1 [8.54] ← |
| Serie 8: | 9.4 [3.73] → | 8.6 [4.98] → | 8.4 [6.08] ↓ | 10.4* [6.97] ↓ | 10.1 [8.01] → |

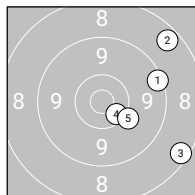
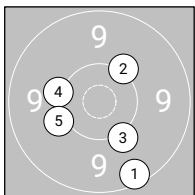
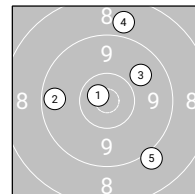
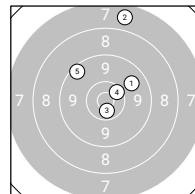
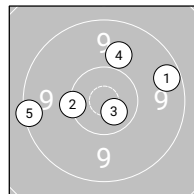
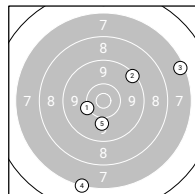
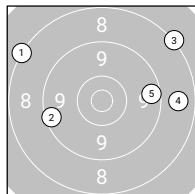
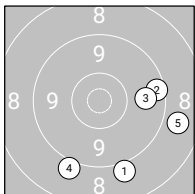

Ergebnis: **343** (363.9)

Wertung: 343 Serien: 43 43 44 41 39 44 46 43

Zähler: 7 15 13 4 1 0 0 0 0 0 0

Innenzehner: 3

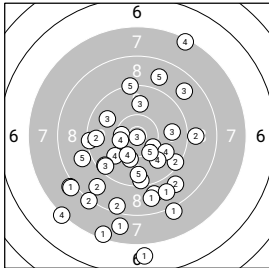

Wertung

Wertung

| | | | | | |
|-----------------|--------------|---------------|----------------|----------------|----------------|
| Serie 1: | 8.1 [4.34] ↘ | 8.8 [5.68] ↘ | 9.8 [6.63] ↙ | 9.9 [7.52] ↙ | 9.4 [8.16] ↓ |
| Serie 2: | 8.1 [3.54] ↗ | 9.4 [4.85] ↘ | 9.9 [5.89] ↑ | 7.3 [6.89] ↗ | 10.4* [7.72] ← |
| Serie 3: | 8.1 [3.73] ↙ | 10.3 [5.38] ↘ | 9.8 [6.34] → | 8.9 [7.35] ↓ | 9.6 [8.35] ↓ |
| Serie 4: | 6.8 [3.79] ↓ | 9.0 [5.23] → | 9.3 [6.24] ← | 9.8 [7.19] ↘ | 8.8 [8.14] ↗ |
| Serie 5: | 7.4 [4.53] ↘ | 8.7 [5.95] ↙ | 8.7 [7.03] ↗ | 7.2 [8.06] ↙ | 9.2 [9.01] ↑ |
| Serie 6: | 7.8 [3.84] ↓ | 9.5 [5.41] ← | 9.5 [6.91] ↙ | 9.9 [7.75] ↘ | 10.2 [8.53] ↘ |
| Serie 7: | 8.8 [4.58] ↓ | 8.5 [6.00] ↘ | 10.9* [7.46] ↓ | 10.4* [8.39] ← | 10.1 [9.34] ↘ |
| Serie 8: | 8.8 [3.67] ↘ | 8.2 [5.34] ↙ | 9.5 [6.69] ↙ | 10.2 [7.62] ↙ | 8.9 [8.95] ↙ |

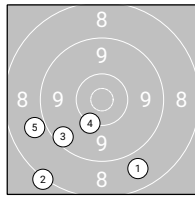
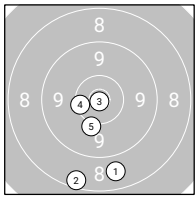
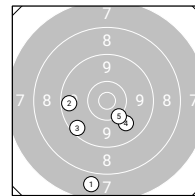
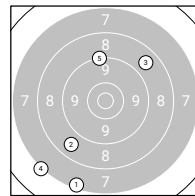
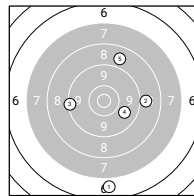
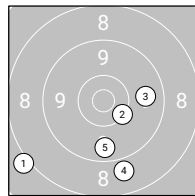
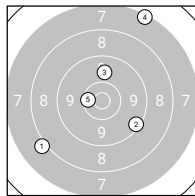
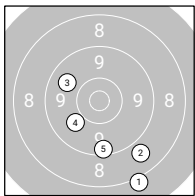

Ergebnis: **299** (315.9)

Wertung: 299 Serien: 32 34 36 43 41 38 35 40

Zähler: 2 13 8 8 4 2 1 0 2 0 0

Innenzehner: 1

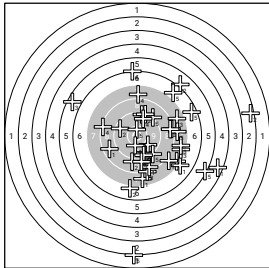

Wertung

Wertung

| | | | | | |
|-----------------|--------------|--------------|--------------|---------------|----------------|
| Serie 1: | 7.8 [4.45] ↓ | 7.1 [5.69] ↓ | 8.2 [6.43] ↓ | 8.4 [7.34] ← | 2.2 [7.60] ↓ |
| Serie 2: | 8.7 [3.48] ↖ | 6.0 [4.73] ↗ | 5.6 [5.65] ↖ | 9.4 [6.48] ↓ | 6.8 [7.41] ↗ |
| Serie 3: | 8.5 [3.51] ↓ | 9.5 [4.78] ↓ | 7.8 [6.02] ↗ | 6.2 [7.21] ↑ | 6.6 [8.17] ↗ |
| Serie 4: | 7.5 [3.34] ↘ | 9.0 [4.67] ↓ | 9.4 [5.40] ↑ | 9.9 [6.27] ↘ | 9.2 [7.08] ↗ |
| Serie 5: | 7.1 [3.34] ↘ | 9.3 [4.67] ↗ | 7.6 [6.05] ↘ | 9.6 [6.53] ↓ | 9.2 [7.25] ↘ |
| Serie 6: | 4.6 [3.48] ↘ | 9.6 [4.94] ↖ | 8.4 [6.24] → | 7.9 [6.98] ↑ | 10.5* [7.86] ↑ |
| Serie 7: | 8.0 [3.90] ↘ | 2.5 [5.47] → | 7.7 [6.78] → | 10.2 [7.63] ↓ | 8.0 [8.31] → |
| Serie 8: | 9.5 [3.91] ↓ | 9.0 [5.16] ↓ | 8.5 [6.24] → | 9.6 [7.36] ↗ | 5.3 [7.97] ↘ |

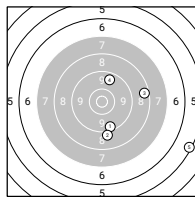
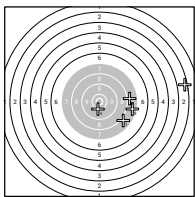
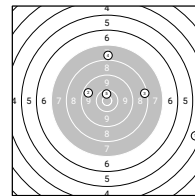
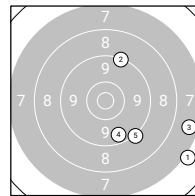
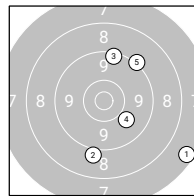
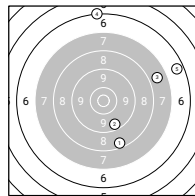
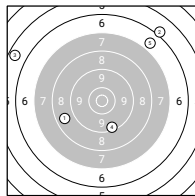
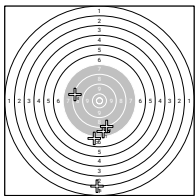

Ergebnis: **319** (336.6)

Wertung: 319 Serien: 43 42 39 40 41 40 38 36

Zähler: 2 10 18 6 3 1 0 0 0 0 0

Innenzehner: 1

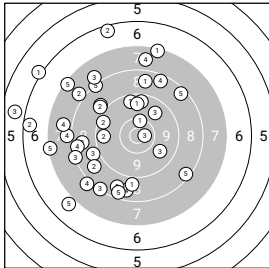

Wertung

Wertung

| | | | | | |
|-----------------|---------------|--------------|----------------|--------------|--------------|
| Serie 1: | 9.5 [3.97] ↑ | 8.7 [5.07] ← | 9.8 [6.06] ↗ | 9.5 [7.65] ↑ | 8.4 [8.72] ↘ |
| Serie 2: | 8.7 [4.37] ↑ | 9.4 [5.09] ↖ | 10.6* [5.78] → | 7.8 [6.70] ↑ | 8.3 [7.56] ↘ |
| Serie 3: | 9.0 [3.67] ↘ | 6.5 [5.03] ← | 8.3 [5.97] ↘ | 8.5 [6.67] ↗ | 8.4 [7.11] ↗ |
| Serie 4: | 7.4 [4.70] ↑ | 9.0 [5.46] ↘ | 9.0 [6.51] ← | 8.7 [7.47] ↓ | 7.0 [8.19] ↘ |
| Serie 5: | 9.6 [4.73] ↑ | 8.0 [5.97] ↘ | 9.8 [6.87] ↘ | 8.1 [7.84] ← | 7.4 [8.34] ↘ |
| Serie 6: | 10.3 [3.93] ↑ | 8.8 [4.95] ↘ | 8.0 [5.94] ↘ | 7.9 [6.72] ← | 7.3 [8.24] ← |
| Serie 7: | 8.9 [4.92] ↓ | 9.6 [6.18] ← | 5.8 [6.84] ← | 8.4 [7.56] ← | 8.7 [8.44] ↘ |
| Serie 8: | 6.1 [4.26] ↘ | 6.5 [6.05] ↑ | 8.3 [6.90] ← | 8.1 [7.71] ↘ | 8.5 [9.14] ↘ |

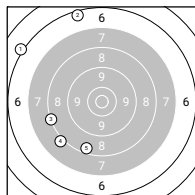
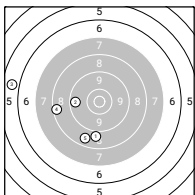
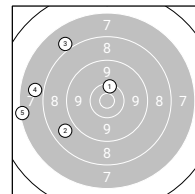
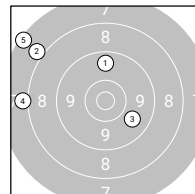
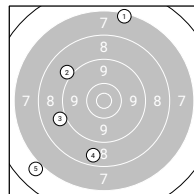
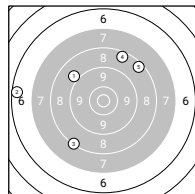
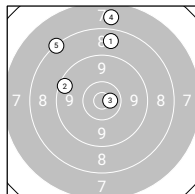
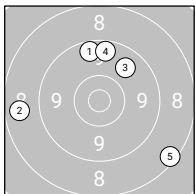

Ergebnis: **295** (313.8)

Wertung: 295 Serien: 38 33 34 33 38 36 41 42

Zähler: 2 9 11 8 4 4 1 0 1 0 0

Innenzehner: 1

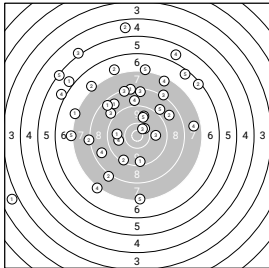

Wertung

Wertung

| | | | | | |
|-----------------|--------------|--------------|----------------|--------------|--------------|
| Serie 1: | 8.3 [3.03] ↑ | 9.4 [4.08] ↓ | 9.0 [5.34] ↘ | 5.8 [6.41] ↗ | 7.3 [7.77] ↓ |
| Serie 2: | 2.9 [4.25] ↙ | 6.4 [5.59] ↗ | 9.9 [6.65] → | 7.7 [7.57] → | 9.8 [8.57] ↗ |
| Serie 3: | 8.7 [3.59] ↘ | 4.7 [5.04] ↑ | 8.3 [6.64] ↑ | 7.2 [8.04] ↓ | 7.1 [8.74] ↑ |
| Serie 4: | 8.5 [4.80] ↘ | 8.2 [5.76] ← | 5.1 [7.75] ↘ | 7.4 [8.66] ↗ | 5.3 [9.33] ↘ |
| Serie 5: | 9.5 [3.94] ↓ | 7.1 [4.70] ↘ | 8.2 [5.91] ↗ | 8.7 [7.17] ↙ | 6.5 [8.41] ↗ |
| Serie 6: | 7.2 [3.12] ↙ | 6.9 [5.39] ↗ | 8.4 [6.47] ↑ | 8.9 [7.52] ↑ | 7.2 [8.71] ← |
| Serie 7: | 5.9 [4.34] ↘ | 8.8 [5.59] ↗ | 10.4 [6.70] ↗ | 9.9 [7.70] ↙ | 9.0 [8.68] ↗ |
| Serie 8: | 9.8 [3.59] ← | 8.1 [4.79] ↓ | 10.5* [6.90] ↗ | 6.0 [8.19] ↙ | 9.8 [9.06] ↗ |

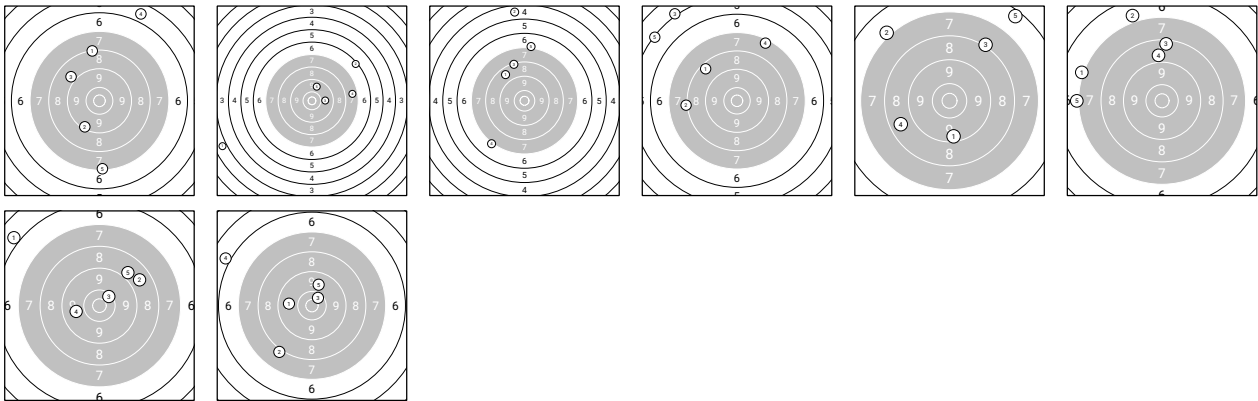

Ergebnis: **321** (334.7)

Wertung: 321 Serien: 37 42 40 40 38 38 45 41

Zähler: 6 10 8 12 3 1 0 0 0 0 0

Innenzehner: 4

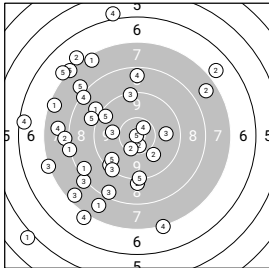

Wertung

Wertung

| | | | | | |
|-----------------|--------------|----------------|---------------|----------------|----------------|
| Serie 1: | 9.4 [2.36] ↙ | 6.9 [3.36] ↗ | 9.3 [4.43] ↑ | 6.0 [5.27] ↑ | 7.2 [6.39] ↘ |
| Serie 2: | 7.4 [2.40] ↘ | 10.5* [3.59] ↓ | 8.4 [4.73] ↙ | 7.8 [5.97] ← | 10.9* [6.70] ← |
| Serie 3: | 5.0 [2.28] ↙ | 7.0 [3.46] ↘ | 9.8 [4.74] → | 10.6* [6.24] ↗ | 9.6 [7.45] ↙ |
| Serie 4: | 7.8 [2.80] ↙ | 9.1 [3.87] ↓ | 8.2 [4.99] ↙ | 7.2 [5.99] ↓ | 9.3 [6.75] ↓ |
| Serie 5: | 9.0 [3.07] ↘ | 7.7 [4.60] ↗ | 7.2 [5.69] ← | 7.1 [6.92] ↙ | 8.0 [8.49] ↘ |
| Serie 6: | 8.5 [2.71] ↙ | 8.1 [4.10] ← | 7.5 [5.11] ↙ | 8.3 [6.12] ↘ | 7.1 [7.19] ↘ |
| Serie 7: | 8.2 [2.83] ← | 10.4* [4.20] ↙ | 10.0 [5.09] ← | 8.6 [5.82] ↑ | 9.5 [6.93] ↘ |
| Serie 8: | 7.4 [2.94] ↙ | 10.0 [4.00] ↘ | 9.3 [5.08] ↙ | 6.4 [6.03] ← | 9.0 [6.92] ← |

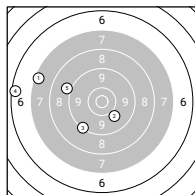
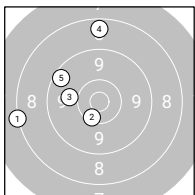
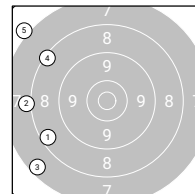
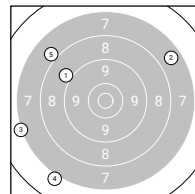
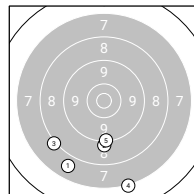
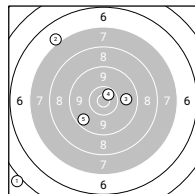
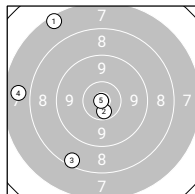
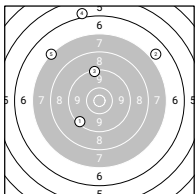

Ergebnis: **339** (358.8)

Wertung: 339 Serien: 38 47 42 42 40 41 45 44

Zähler: 10 11 9 8 2 0 0 0 0 0 0

Innenzehner: 5

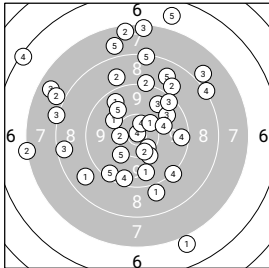

Wertung

Wertung

| | | | | | |
|-----------------|---------------|----------------|--------------|----------------|----------------|
| Serie 1: | 8.7 [3.09] ↙ | 7.5 [4.44] ↑ | 7.7 [5.57] ↙ | 10.9* [6.79] ↑ | 6.8 [7.81] ↑ |
| Serie 2: | 9.6 [2.08] ↙ | 10.4* [3.24] ← | 8.2 [4.28] ↙ | 10.5* [5.50] ↑ | 10.4* [6.56] ↘ |
| Serie 3: | 10.0 [2.34] ↙ | 7.2 [3.66] ← | 8.5 [5.16] ← | 9.5 [6.54] → | 8.7 [7.74] ↑ |
| Serie 4: | 10.2 [3.21] ↘ | 8.9 [4.59] ↑ | 7.3 [5.84] ↑ | 8.2 [6.95] ↗ | 9.4 [7.94] ↙ |
| Serie 5: | 7.0 [2.72] ↘ | 9.2 [4.45] ↑ | 9.7 [5.84] ↗ | 6.3 [7.03] ↙ | 9.9 [8.21] ↙ |
| Serie 6: | 8.9 [2.16] ↘ | 7.9 [3.70] ↙ | 7.9 [5.10] ↗ | 9.2 [6.57] ↘ | 10.1 [7.74] ↙ |
| Serie 7: | 10.3 [2.40] ↗ | 10.4* [3.85] ↘ | 9.7 [5.20] ↗ | 9.5 [6.25] ↘ | 7.9 [7.42] ↑ |
| Serie 8: | 9.7 [2.74] ↘ | 8.9 [4.47] ↗ | 9.4 [5.89] ↗ | 10.0 [7.13] ↗ | 8.3 [8.34] ↑ |

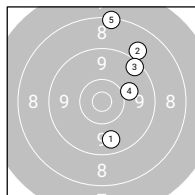
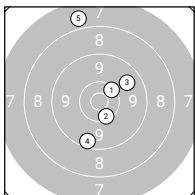
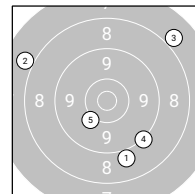
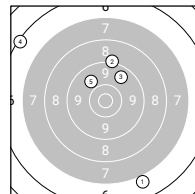
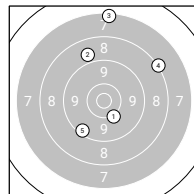
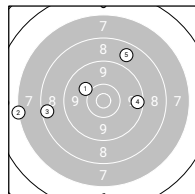
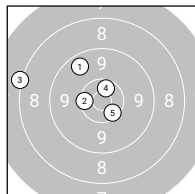
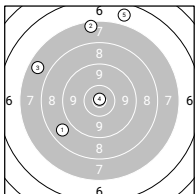

Ergebnis: **360** (378.6)

Wertung: 360 Serien: 46 48 45 45 43 44 44 45

Zähler: 13 16 9 2 0 0 0 0 0 0

Innenzehner: 5

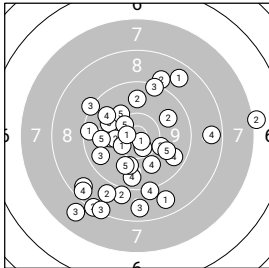

Wertung

Wertung

| | | | | | |
|-----------------|----------------|---------------|---------------|---------------|----------------|
| Serie 1: | 8.7 [3.00] ↗ | 9.8 [4.14] ↗ | 10.2 [5.19] ← | 9.6 [6.19] ↘ | 10.1 [7.24] ← |
| Serie 2: | 9.4 [2.25] ← | 9.0 [3.32] ↗ | 10.1 [4.17] ↘ | 10.3 [5.29] ← | 10.0 [6.21] ← |
| Serie 3: | 10.5* [3.08] ↘ | 10.3 [4.25] ← | 8.6 [5.14] ↓ | 8.6 [6.10] → | 9.8 [7.20] ← |
| Serie 4: | 8.6 [3.12] ↙ | 9.0 [4.39] ↓ | 9.2 [5.45] ↗ | 9.6 [6.56] ↓ | 10.0 [7.48] ↓ |
| Serie 5: | 8.7 [3.24] ↘ | 9.8 [4.23] ↑ | 7.8 [5.19] ↙ | 9.9 [6.24] ↘ | 10.1 [7.23] ↗ |
| Serie 6: | 10.4* [2.71] ← | 8.3 [3.86] ↙ | 8.3 [5.19] ↙ | 9.8 [6.39] ↗ | 9.9 [7.53] ↙ |
| Serie 7: | 10.7* [2.71] ↘ | 7.1 [3.78] → | 9.6 [4.92] ← | 8.5 [5.91] ↙ | 10.4* [7.20] ↗ |
| Serie 8: | 10.6* [2.53] ← | 8.9 [3.64] ↙ | 9.3 [4.62] ↗ | 9.2 [5.56] ↓ | 9.9 [6.80] ↘ |

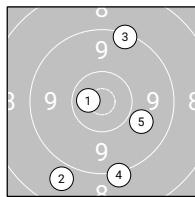
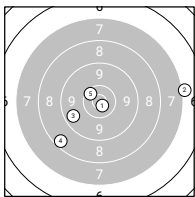
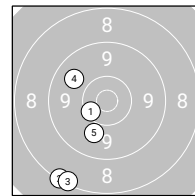
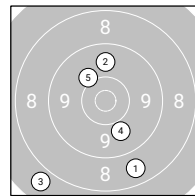
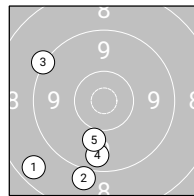
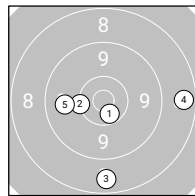
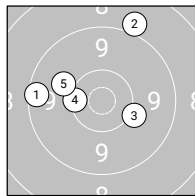
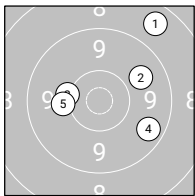

Ergebnis: **297** (313.1)

Wertung: 297 Serien: 35 35 45 33 39 36 34 40

Zähler: 3 7 13 6 7 2 0 2 0 0 0

Innenzehner: 0

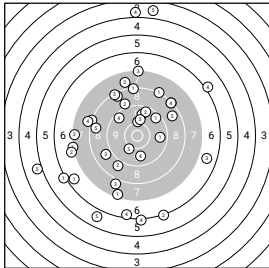

Wertung

Wertung

| | | | | | |
|-----------------|--------------|--------------|---------------|--------------|---------------|
| Serie 1: | 7.4 [1.59] ↓ | 8.2 [2.68] ↙ | 9.7 [3.71] ↑ | 6.4 [4.88] ↓ | 5.8 [5.80] ↘ |
| Serie 2: | 8.2 [1.39] ↑ | 6.2 [2.30] ↘ | 7.3 [3.06] ↑ | 6.2 [4.22] ↓ | 8.7 [5.11] ↗ |
| Serie 3: | 9.5 [1.49] ↗ | 9.0 [2.64] ↗ | 8.4 [3.88] ↗ | 9.8 [4.93] ↓ | 10.1 [6.06] ↘ |
| Serie 4: | 8.3 [2.53] ↑ | 8.9 [3.55] ↘ | 8.3 [4.83] ↗ | 6.1 [6.25] ↗ | 3.8 [7.54] ↑ |
| Serie 5: | 9.6 [2.52] → | 7.8 [3.64] ↑ | 6.8 [5.66] → | 9.5 [6.53] ↙ | 8.6 [7.36] ↙ |
| Serie 6: | 6.1 [2.33] ↙ | 9.5 [3.60] ↗ | 8.0 [4.67] ↘ | 8.0 [5.84] ↙ | 5.0 [6.73] ↙ |
| Serie 7: | 6.6 [1.33] ↙ | 7.4 [2.81] ↙ | 10.2 [4.03] ↑ | 3.9 [5.20] ↑ | 8.3 [6.14] ↗ |
| Serie 8: | 7.2 [2.67] ↙ | 7.1 [4.04] ↙ | 8.9 [4.92] ↙ | 8.3 [5.84] ↗ | 10.0 [6.92] ↑ |

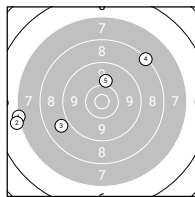
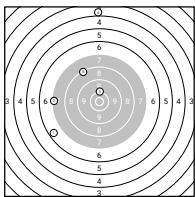
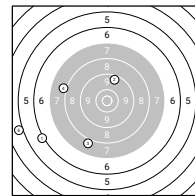
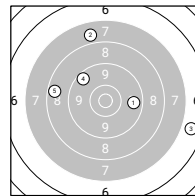
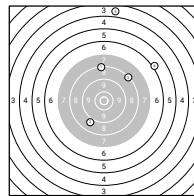
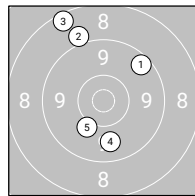
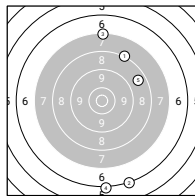
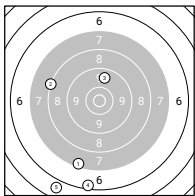

Ergebnis: **253** (271.7)

Wertung: 253 Serien: 32 33 36 19 30 32 36 35

Zähler: 1 10 4 6 3 7 3 4 1 0 0

Innenzehner: 0

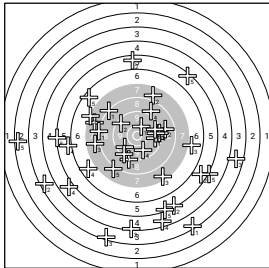

Wertung

Wertung

| | | | | | |
|-----------------|---------------|--------------|--------------|--------------|--------------|
| Serie 1: | 7.8 [2.50] ← | 9.5 [3.60] ↗ | 7.9 [4.61] ← | 4.6 [5.72] ↓ | 5.3 [6.88] ← |
| Serie 2: | 8.2 [2.46] ← | 8.9 [3.54] → | 9.8 [4.74] ↙ | 6.0 [5.52] ← | 2.5 [6.36] ← |
| Serie 3: | 9.7 [2.45] → | 5.4 [3.66] ↓ | 7.5 [5.25] ↓ | 9.4 [6.11] → | 6.6 [6.87] ↘ |
| Serie 4: | 3.4 [3.28] ↓ | 5.6 [4.09] ↑ | 7.0 [5.02] → | 4.9 [7.03] ↙ | |
| Serie 5: | 9.2 [2.63] ↓ | 3.5 [3.92] ← | 4.3 [5.44] ↓ | 9.9 [6.23] ↓ | 5.3 [7.13] ↓ |
| Serie 6: | 9.3 [2.68] ↙ | 9.6 [4.10] → | 3.7 [4.90] → | 6.8 [5.77] ↙ | 5.2 [6.64] → |
| Serie 7: | 10.2 [2.46] ↗ | 5.7 [3.23] ↓ | 7.3 [4.34] ← | 9.6 [5.75] → | 5.4 [6.87] ↗ |
| Serie 8: | 8.3 [2.63] ↘ | 7.9 [3.80] ↗ | 3.4 [4.69] ↓ | 9.0 [5.85] ↗ | 8.1 [6.65] ↙ |

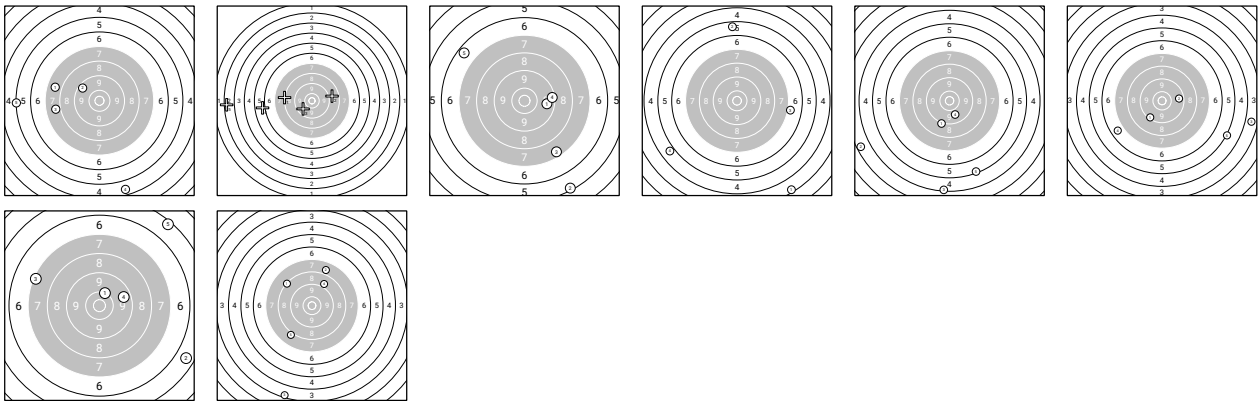

Ergebnis: **268** (289.4)

Wertung: 268 Serien: 28 25 40 39 37 30 37 32

Zähler: 1 7 10 5 8 2 3 3 0 1 0

Innenzehner: 0

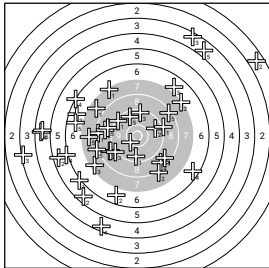

Wertung

Wertung

| | | | | | |
|-----------------|--------------|--------------|--------------|---------------|--------------|
| Serie 1: | 8.4 [5.37] ← | 9.7 [6.01] → | 3.5 [6.93] ↗ | 4.6 [7.62] ← | 4.7 [8.21] ← |
| Serie 2: | 7.4 [4.88] ↘ | 5.6 [5.33] ← | 6.7 [6.12] ← | 4.5 [6.68] ↘ | 3.8 [7.94] ↗ |
| Serie 3: | 7.7 [5.20] ↘ | 8.8 [6.23] ← | 8.9 [6.89] ← | 8.9 [7.38] ← | 9.6 [7.78] ↗ |
| Serie 4: | 9.1 [4.99] → | 5.6 [5.52] ↘ | 7.5 [6.26] ↘ | 10.3 [6.86] ↘ | 8.9 [7.77] ← |
| Serie 5: | 9.4 [5.19] ↘ | 7.3 [5.89] → | 9.2 [6.50] ↘ | 6.2 [7.27] ↘ | 6.8 [7.97] ← |
| Serie 6: | 6.1 [4.48] ← | 6.8 [5.27] ↘ | 3.4 [5.86] ← | 8.6 [6.68] ↘ | 7.8 [7.11] ← |
| Serie 7: | 9.6 [6.83] ↓ | 8.2 [7.29] ↘ | 6.9 [7.96] ↗ | 6.1 [8.49] ← | 8.1 [9.01] ← |
| Serie 8: | 8.6 [5.91] ↘ | 1.7 [6.59] → | 9.4 [7.41] ↑ | 6.6 [8.06] ↘ | 8.4 [8.58] → |

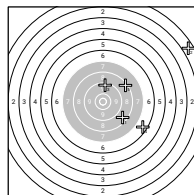
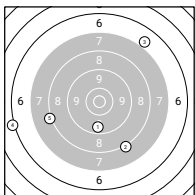
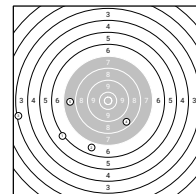
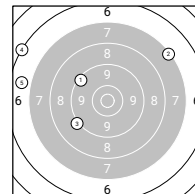
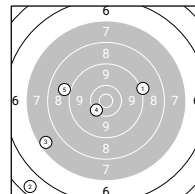
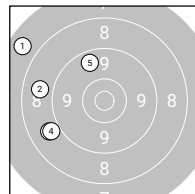
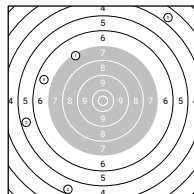
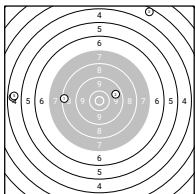

Ergebnis: 217 (236.3)

Wertung: 217 Serien: 29 33 18 10 32 30 32 33

Zähler: 1 2 6 6 7 4 4 5 3 0 1

Innenzehner: 0

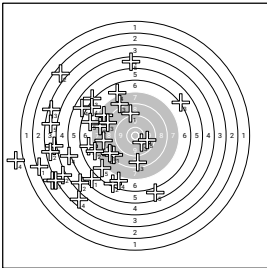

Wertung

Wertung

| | | | | | |
|-----------------|--------------|--------------|---------------|--------------|--------------|
| Serie 1: | 8.4 [3.37] ↙ | 7.8 [4.81] ↘ | 6.1 [5.44] ↘ | 6.5 [6.19] ↘ | 2.9 [7.24] ↙ |
| Serie 2: | 9.0 [2.95] ↑ | 7.9 [4.01] ↙ | 6.2 [5.30] ↘ | 7.0 [6.16] ↘ | 4.7 [7.26] ↑ |
| Serie 3: | 5.8 [2.88] ↙ | 2.7 [4.15] ↘ | 3.5 [5.03] ↙ | 5.9 [5.79] ↘ | 3.7 [6.52] ↙ |
| Serie 4: | 2.4 [2.73] ↙ | 4.0 [4.75] ↙ | 4.0 [5.78] ↙ | 0.0 [6.54] ↙ | |
| Serie 5: | 6.9 [3.08] ↙ | 3.6 [4.11] ↙ | 8.4 [4.93] ↘ | 8.2 [5.91] ↙ | 7.0 [6.86] ↘ |
| Serie 6: | 8.5 [2.98] ↙ | 6.5 [4.00] ↘ | 8.7 [4.85] ↓ | 3.7 [5.65] ↘ | 5.8 [6.41] ↘ |
| Serie 7: | 3.2 [3.07] ↙ | 4.8 [4.67] ↘ | 10.2 [5.51] ↘ | 6.9 [6.65] ↘ | 9.9 [7.41] ↘ |
| Serie 8: | 8.3 [3.09] ↙ | 7.3 [4.61] ↙ | 7.9 [5.38] ↘ | 5.1 [6.21] ↙ | 6.9 [6.91] ↘ |

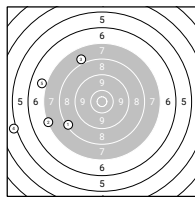
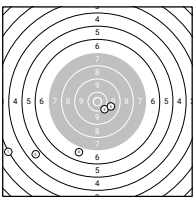
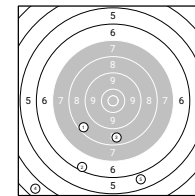
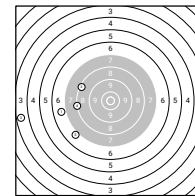
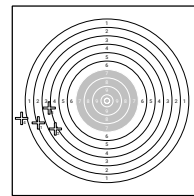
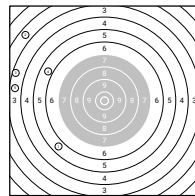
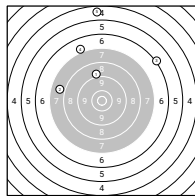
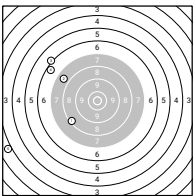

Ergebnis: **314** (332.5)

Wertung: 314 Serien: 40 40 44 41 39 35 40 35

Zähler: 9 7 9 5 7 1 1 1 0 0 0

Innenzehner: 4

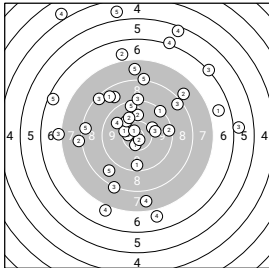

Wertung

Wertung

| | | | | | |
|-----------------|----------------|----------------|---------------|---------------|----------------|
| Serie 1: | 10.1 [2.79] ↗ | 7.9 [4.12] ↗ | 6.0 [5.00] → | 7.7 [5.93] ↓ | 10.5* [6.89] ← |
| Serie 2: | 10.3 [2.15] ← | 8.8 [3.19] ↗ | 8.4 [4.56] ↗ | 10.1 [5.43] ↗ | 4.8 [6.79] ↑ |
| Serie 3: | 9.3 [1.28] ↗ | 9.9 [4.06] ↑ | 8.2 [5.20] ↓ | 9.8 [5.94] ↗ | 9.5 [7.00] ↑ |
| Serie 4: | 10.5* [2.09] ↓ | 10.7* [3.35] ↓ | 10.0 [4.13] → | 3.9 [5.57] ↗ | 8.8 [6.94] ↗ |
| Serie 5: | 10.7* [4.80] ↗ | 8.1 [5.68] ← | 8.5 [6.29] ↗ | 6.1 [7.03] ↗ | 7.7 [7.75] ↑ |
| Serie 6: | 9.5 [2.34] ↓ | 6.9 [3.47] ↑ | 7.1 [4.75] ← | 5.5 [5.59] ↗ | 8.4 [7.10] ← |
| Serie 7: | 8.6 [2.40] ↗ | 10.0 [3.42] ↗ | 9.2 [5.03] ↑ | 7.0 [6.16] ↓ | 6.5 [7.96] ← |
| Serie 8: | 6.8 [2.46] → | 9.4 [3.78] → | 6.2 [5.23] ↗ | 6.9 [6.30] ↓ | 8.2 [7.27] ↑ |

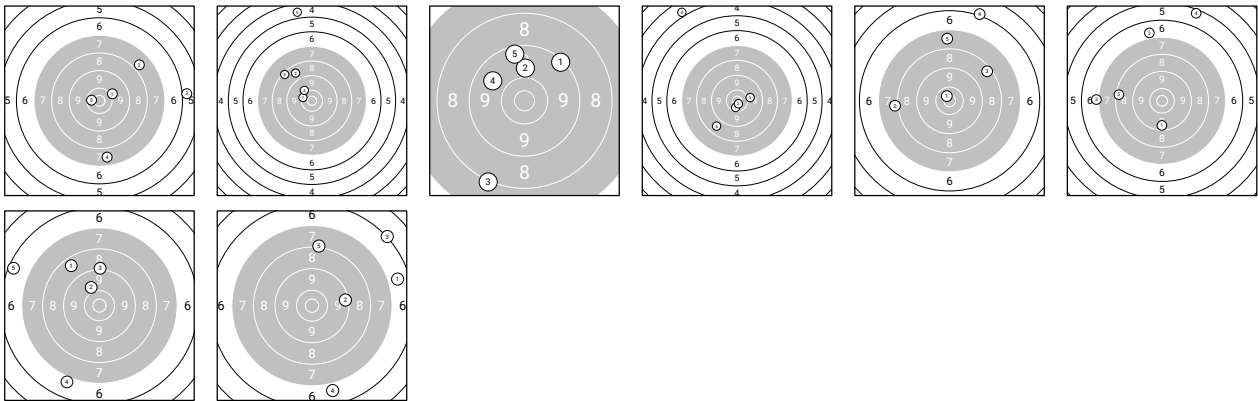

Ergebnis: **303** (319.5)

Wertung: 303 Serien: 39 38 30 40 43 38 34 41

Zähler: 4 8 12 8 3 2 2 1 0 0 0

Innenzehner: 2

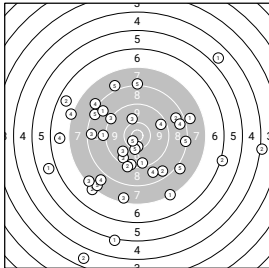

Wertung

Wertung

| | | | | | |
|-----------------|--------------|--------------|----------------|--------------|----------------|
| Serie 1: | 7.9 [2.91] → | 6.1 [4.61] → | 9.5 [5.99] ↓ | 9.3 [7.38] ↓ | 8.1 [8.68] ↑ |
| Serie 2: | 4.8 [3.26] ↗ | 8.6 [4.28] → | 10.4* [5.61] ↓ | 8.1 [6.98] ↖ | 8.4 [8.35] ↖ |
| Serie 3: | 5.1 [2.99] ↓ | 3.7 [4.58] ↓ | 8.5 [6.13] ← | 6.7 [7.46] ← | 8.0 [8.89] ↗ |
| Serie 4: | 9.4 [2.86] ↓ | 7.1 [4.04] ↓ | 7.5 [5.77] ↓ | 7.2 [7.85] ↖ | 10.2 [9.14] ↓ |
| Serie 5: | 9.1 [3.55] ← | 8.6 [4.88] ↓ | 10.0 [6.14] ↑ | 9.5 [7.51] → | 7.5 [9.10] ↓ |
| Serie 6: | 7.3 [3.32] ↓ | 6.7 [5.12] ↖ | 9.8 [6.61] ↓ | 8.8 [7.91] ↓ | 8.3 [8.93] → |
| Serie 7: | 5.8 [2.80] ← | 4.1 [5.24] → | 7.4 [6.09] ↓ | 8.5 [7.19] → | 10.6* [8.18] ↓ |
| Serie 8: | 8.7 [2.81] ↖ | 9.2 [4.13] ↓ | 9.2 [5.80] ↖ | 7.8 [7.46] ↓ | 8.0 [8.67] ↘ |

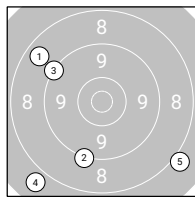
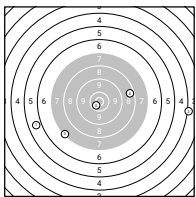
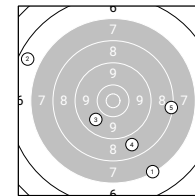
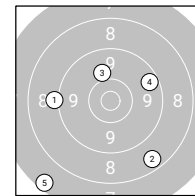
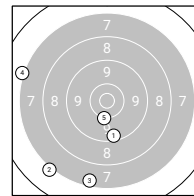
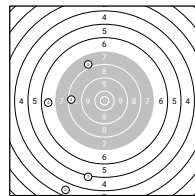
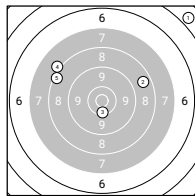
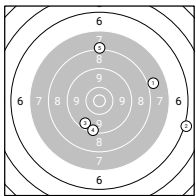

Ergebnis: **320** (335.7)

Wertung: 320 Serien: 37 37 42 39 43 40 39 43

Zähler: 8 9 10 4 6 3 0 0 0 0 0

Innenzehner: 2

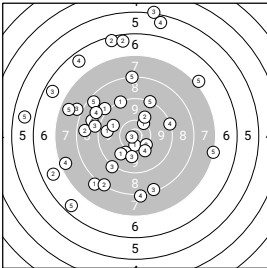

Wertung

Wertung

| | | | | | |
|-----------------|----------------|---------------|----------------|---------------|--------------|
| Serie 1: | 10.5* [2.84] ↓ | 8.6 [4.29] ← | 6.6 [4.89] ↙ | 8.8 [6.37] ↙ | 5.8 [6.78] ← |
| Serie 2: | 9.6 [2.31] ← | 6.4 [3.25] ↑ | 9.0 [4.07] ← | 6.6 [4.85] ↘ | 7.3 [5.69] → |
| Serie 3: | 9.2 [2.41] ↗ | 10.3 [3.35] ↘ | 8.3 [4.72] ↓ | 7.5 [5.53] ← | 8.5 [6.36] ↘ |
| Serie 4: | 9.8 [3.47] ↘ | 6.8 [4.59] ← | 8.0 [5.33] ↙ | 9.3 [6.66] → | 7.1 [7.25] ↗ |
| Serie 5: | 10.3 [3.01] ↗ | 10.1 [4.16] ↘ | 10.8* [5.21] ← | 5.6 [6.19] ↑ | 8.2 [7.17] ↑ |
| Serie 6: | 8.0 [3.18] ↘ | 6.5 [4.22] ↑ | 9.2 [4.80] ↘ | 10.1 [6.10] ↘ | 7.6 [6.77] ← |
| Serie 7: | 9.1 [3.01] ↘ | 8.3 [4.08] ↘ | 5.2 [5.23] ↑ | 8.2 [6.00] ↓ | 9.2 [6.79] ↗ |
| Serie 8: | 9.9 [2.12] ↘ | 10.0 [3.25] ↗ | 10.0 [5.29] ↓ | 8.8 [5.95] ↙ | 6.6 [6.48] ↘ |

