

Ergebnis: **312.4** (298)  
 Serien: 103.3 104.4 104.7  
 Zähler: 28 2 0 0 0 0 0 0 0 0  
 Innenezehner: 26  
 Weitestе: 419 (3.), 301 (11.), 226 (25.)  
 beste Teiler: 44.9 (19.), 47.9 (14.), 51.4 (26.)  
 Trefferkreis: 11.05 mm  
 Trefferlage: 0.04 mm rechts, 0.17 mm hoch

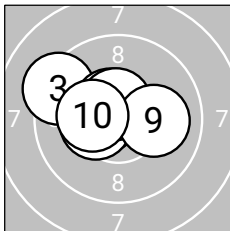
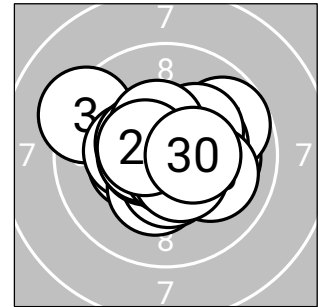

**Serie 1: 103.3** (99)

10.5*↖	10.7*↗	9.3↖	10.4*↖	10.5*↖
10.4*↖	10.5*↗	10.6*↗	10.1→	10.3*↖

beste Teiler: 57.2 (2.), 93.2 (8.), 102.1 (5.)  
 Trefferkreis: 10.79 mm  
 Trefferlage: 0.86 mm links, 0.47 mm hoch

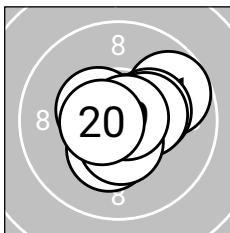

**Serie 2: 104.4** (99)

9.7↗	10.3*↘	10.5*↗	10.8*↗	10.3*↗
10.4*↗	10.5*↖	10.5*↘	10.8*↗	10.6*↖

beste Teiler: 44.9 (19.), 47.9 (14.), 87.5 (20.)  
 Trefferkreis: 8.81 mm  
 Trefferlage: 0.55 mm rechts, 0.06 mm hoch

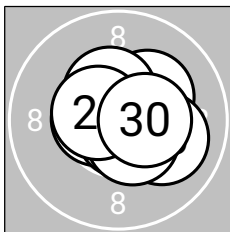

**Serie 3: 104.7** (100)

10.2*↗	10.4*↗	10.6*↖	10.7*↗	10.0↗
10.7*↗	10.7*↘	10.5*↘	10.5*↖	10.4*↗

beste Teiler: 51.4 (26.), 58.1 (24.), 58.6 (27.)  
 Trefferkreis: 7.84 mm  
 Trefferlage: 0.43 mm rechts, 0.00 mm



# ISSF AR Mixed Final

StandNr: A

Urdl, Fernanda #70401085

# Mixed Team

Medal Match

StartNr: 225

06.02.2026 19:24

SG\_Angerberg

SG Angerberg 1

Ergebnis: **164.6** (158)  
Serien: 51.2 51.8 51.3 10.3  
Zähler: 14 2 0 0 0 0 0 0 0 0  
Innenzehner: 10  
Weiteste: 430 (14.), 279 (6.), 223 (8.)  
beste Teiler: 36.6 (9.), 53.0 (12.), 60.4 (15.)  
Trefferkreis: 10.96 mm  
Trefferlage: 0.35 mm rechts, 0.10 mm hoch

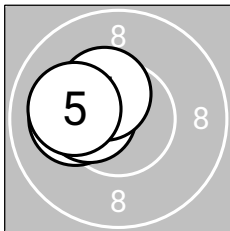
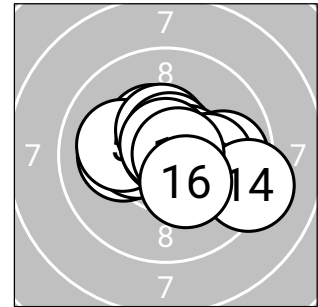

**Serie 1: 51.2** (50)

10.1 ←

10.2\* ←

10.4\* ←

10.4\* ↖

10.1 ←

beste Teiler: 138.3 (4.), 138.7 (3.), 176.1 (2.)  
Trefferkreis: 6.36 mm  
Trefferlage: 1.58 mm links, 0.47 mm hoch

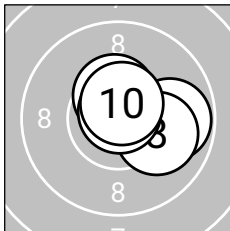

**Serie 2: 51.8** (49)

9.8 →

10.5\* ↑

10.1 →

10.8\* ↑

10.6\* ↑

beste Teiler: 36.6 (9.), 83.1 (10.), 124.7 (7.)  
Trefferkreis: 7.77 mm  
Trefferlage: 0.98 mm rechts, 0.30 mm hoch

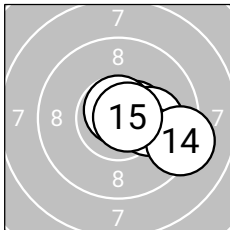

**Serie 3: 51.3** (49)

10.6\* →

10.7\* ↑

10.1 →

9.2 →

10.7\* →

beste Teiler: 53.0 (12.), 60.4 (15.), 100.0 (11.)  
Trefferkreis: 9.01 mm  
Trefferlage: 1.53 mm rechts, 0.17 mm tief

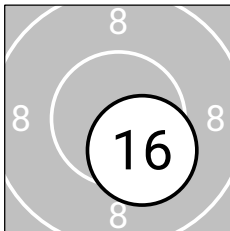

**Serie 4: 10.3** (10)

10.3\* ↘

beste Teiler: 162.8 (16.)  
Trefferkreis: 4.50 mm  
Trefferlage: 0.98 mm rechts, 1.30 mm tief



Ergebnis: **317.5 (300)**  
 Serien: 105.2 106.1 106.2  
 Zähler: 30 0 0 0 0 0 0 0 0 0 0  
 Innenzehner: 28  
 Weitest: 210 (23.), 206 (1.), 183 (11.)  
 beste Teiler: 11.4 (28.), 27.8 (14.), 30.0 (4.)  
 Trefferkreis: 8.46 mm  
 Trefferlage: 0.10 mm rechts, 0.27 mm tief

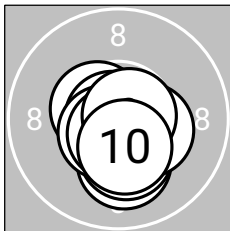
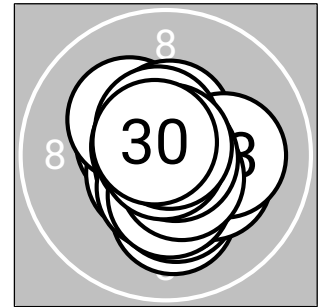

**Serie 1: 105.2 (100)**

10.1 ↓	10.7* ↓	10.5* ←	10.8* ←	10.3* ↓
10.6* ↙	10.4* →	10.7* ↓	10.7* →	10.4* ↓

beste Teiler: 30.0 (4.), 53.6 (2.), 54.1 (9.)  
 Trefferkreis: 7.40 mm  
 Trefferlage: 0.08 mm rechts, 0.67 mm tief

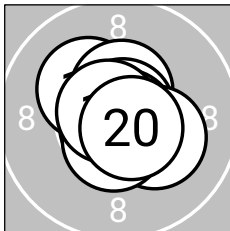

**Serie 2: 106.1 (100)**

10.2* ↖	10.5* ↑	10.8* ↗	10.8* →	10.8* ↙
10.8* ↙	10.2* →	10.6* ↓	10.7* ←	10.7* →

beste Teiler: 27.8 (14.), 33.6 (15.), 41.1 (13.)  
 Trefferkreis: 8.09 mm  
 Trefferlage: 0.02 mm rechts, 0.03 mm hoch

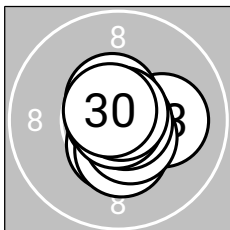

**Serie 3: 106.2 (100)**

10.5* ↓	10.8* ←	10.1 →	10.4* ↓	10.6* ↑
10.6* ↘	10.8* →	10.9* ←	10.8* ↗	10.7* ↖

beste Teiler: 11.4 (28.), 31.7 (22.), 34.0 (29.)  
 Trefferkreis: 7.38 mm  
 Trefferlage: 0.20 mm rechts, 0.17 mm tief

# ISSF AR Mixed Final

StandNr: B

**Oberhauser, Wolfgang** #70401021

# Mixed Team

Medal Match

**StartNr: 226**

06.02.2026 19:24

SG\_Angerberg

SG Angerberg 1

Ergebnis: **168.1** (159)  
Serien: 52.7 51.7 53.0 10.7  
Zähler: 15 1 0 0 0 0 0 0 0 0  
Innenzehner: 14  
Weiteste: 259 (10.), 201 (9.), 170 (1.)  
beste Teiler: 25.1 (13.), 42.9 (2.), 50.0 (8.)  
Trefferkreis: 8.59 mm  
Trefferlage: 0.07 mm rechts, 0.03 mm tief

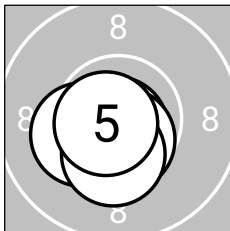
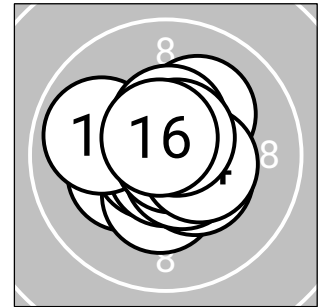

**Serie 1: 52.7** (50)

10.3\*↙

10.8\*↓

10.6\*↓

10.3\*↓

10.7\*↙

beste Teiler: 42.9 (2.), 57.9 (5.), 92.4 (3.)  
Trefferkreis: 6.28 mm  
Trefferlage: 0.44 mm links, 0.74 mm tief

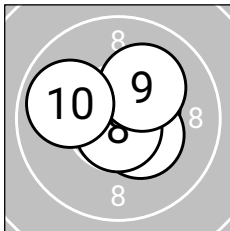

**Serie 2: 51.7** (49)

10.5\*↗

10.4\*↘

10.8\*↓

10.1↗

9.9↙

beste Teiler: 50.0 (8.), 109.9 (6.), 141.6 (7.)  
Trefferkreis: 8.59 mm  
Trefferlage: 0.16 mm rechts, 0.31 mm hoch

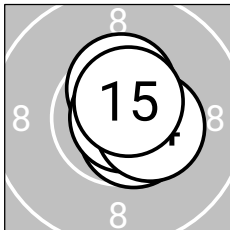

**Serie 3: 53.0** (50)

10.5\*↑

10.6\*↘

10.9\*→

10.4\*→

10.6\*↗

beste Teiler: 25.1 (13.), 79.9 (15.), 88.4 (12.)  
Trefferkreis: 6.48 mm  
Trefferlage: 0.54 mm rechts, 0.19 mm hoch

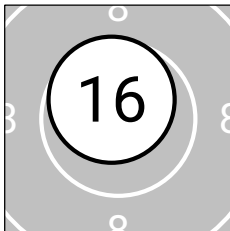

**Serie 4: 10.7** (10)

10.7\*↑

beste Teiler: 72.1 (16.)  
Trefferkreis: 4.50 mm  
Trefferlage: 0.24 mm links, 0.68 mm hoch

Ergebnis: **312.0** (298)  
 Serien: 104.3 102.9 104.8  
 Zähler: 28 2 0 0 0 0 0 0 0 0  
 Innenzehner: 26  
 Weitester: 335 (2.), 258 (12.), 239 (15.)  
 beste Teiler: 10.0 (23.), 28.6 (25.), 40.0 (8.)  
 Trefferkreis: 10.23 mm  
 Trefferlage: 0.18 mm links, 0.00 mm

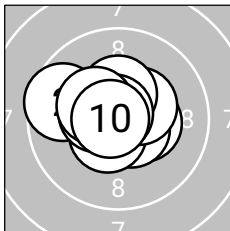
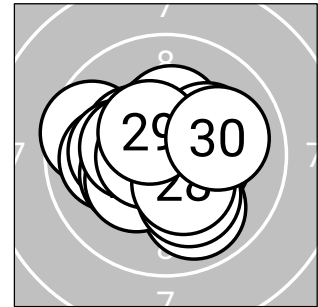

**Serie 1: 104.3** (99)

10.4*→	9.6←	10.6*↘	10.5*↙	10.5*←
10.4*↗	10.4*↑	10.8*↖	10.3*↖	10.8*←

beste Teiler: 40.0 (8.), 47.0 (10.), 93.4 (3.)  
 Trefferkreis: 9.30 mm  
 Trefferlage: 0.37 mm links, 0.28 mm hoch

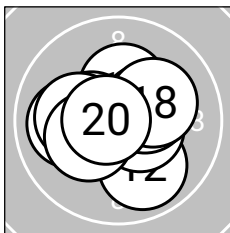

**Serie 2: 102.9** (99)

10.3*↑	9.9↘	10.5*→	10.4*←	10.0←
10.2*←	10.4*↗	10.2*↗	10.3*↖	10.7*←

beste Teiler: 62.0 (20.), 115.4 (13.), 136.7 (14.)  
 Trefferkreis: 9.08 mm  
 Trefferlage: 0.21 mm links, 0.00 mm

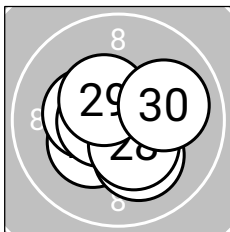

**Serie 3: 104.8** (100)

10.3*↙	10.8*↘	10.9*↘	10.3*←	10.8*↘
10.6*←	10.2*↘	10.4*↘	10.5*↖	10.0→

beste Teiler: 10.0 (23.), 28.6 (25.), 46.0 (22.)  
 Trefferkreis: 8.46 mm  
 Trefferlage: 0.03 mm rechts, 0.26 mm tief



# ISSF AR Mixed Final

StandNr: G

Entner, Amita #70425183

# Mixed Team

Medal Match

StartNr: 227

06.02.2026 19:17

SG\_Wörgl

SG Wörgl 1

Ergebnis: **115.3** (110)  
Serien: 52.7 52.1 10.5  
Zähler: 11 0 0 0 0 0 0 0 0 0 0  
Innenzehner: 9  
Weiteste: 208 (9.), 203 (5.), 142 (6.)  
beste Teiler: 19.7 (1.), 68.9 (3.), 80.5 (7.)  
Trefferkreis: 7.99 mm  
Trefferlage: 0.13 mm links, 0.56 mm tief

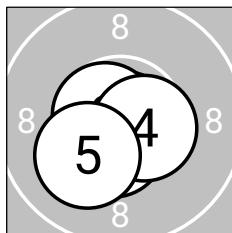
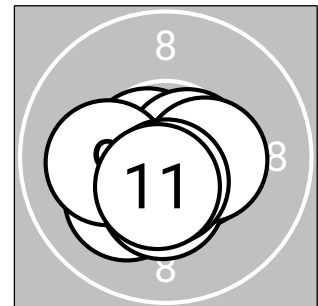

### Serie 1: 52.7 (50)

10.9\*↘

10.5\*↓

10.7\*↙

10.5\*→

10.1↘

beste Teiler: 19.7 (1.), 68.9 (3.), 104.9 (2.)

Trefferkreis: 7.17 mm

Trefferlage: 0.24 mm links, 0.53 mm tief

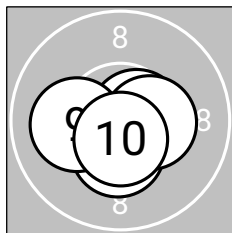

### Serie 2: 52.1 (50)

10.4\*↓

10.6\*→

10.4\*→

10.1←

10.6\*↓

beste Teiler: 80.5 (7.), 89.0 (10.), 141.3 (8.)

Trefferkreis: 7.99 mm

Trefferlage: 0.00 mm, 0.48 mm tief

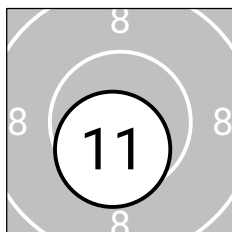

### Serie 3: 10.5 (10)

10.5\*↓

beste Teiler: 110.1 (11.)

Trefferkreis: 4.50 mm

Trefferlage: 0.30 mm links, 1.06 mm tief



Ergebnis: **312.4** (299)  
 Serien: 103.9 104.0 104.5  
 Zähler: 29 1 0 0 0 0 0 0 0 0  
 Innenzehner: 26  
 Weitest: 341 (9.), 250 (27.), 217 (15.)  
 beste Teiler: 49.2 (3.), 55.0 (13.), 61.1 (2.)  
 Trefferkreis: 9.68 mm  
 Trefferlage: 0.47 mm links, 0.02 mm tief

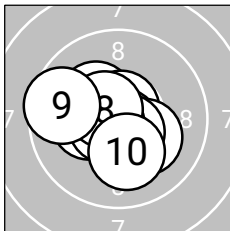
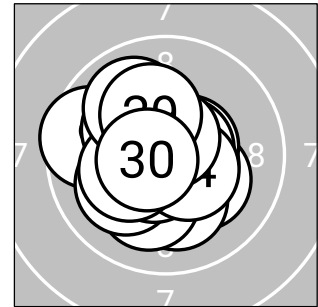

**Serie 1: 103.9** (99)

10.3*↖	10.7*↗	10.8*↘	10.3*↖	10.2*↘
10.6*↘	10.6*↖	10.6*↖	9.6↖	10.2*↘

beste Teiler: 49.2 (3.), 61.1 (2.), 78.2 (7.)  
 Trefferkreis: 9.68 mm  
 Trefferlage: 0.50 mm links, 0.17 mm tief

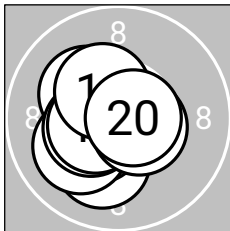

**Serie 2: 104.0** (100)

10.1↘	10.2*↖	10.7*↖	10.4*↖	10.1↖
10.4*↖	10.5*↖	10.4*↖	10.5*↗	10.7*↗

beste Teiler: 55.0 (13.), 70.0 (20.), 105.8 (19.)  
 Trefferkreis: 7.80 mm  
 Trefferlage: 0.69 mm links, 0.30 mm tief

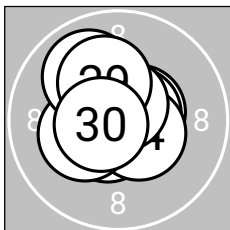

**Serie 3: 104.5** (100)

10.5*↗	10.6*↗	10.6*↘	10.5*↘	10.6*↗
10.3*↖	10.0↖	10.6*↗	10.2*↖	10.6*↖

beste Teiler: 77.2 (28.), 82.2 (22.), 85.6 (30.)  
 Trefferkreis: 8.13 mm  
 Trefferlage: 0.23 mm links, 0.40 mm hoch

# ISSF AR Mixed Final

StandNr: H

**Kecht, Nicolas** #70425023

# Mixed Team

Medal Match

**StartNr: 228**

06.02.2026 19:17

SG\_Wörgl

SG Wörgl 1

Ergebnis: **115.4** (109)  
Serien: 51.8 52.8 10.8  
Zähler: 10 1 0 0 0 0 0 0 0 0  
Innenzehner: 9  
Weiteste: 284 (5.), 201 (2.), 186 (6.)  
beste Teiler: 17.1 (7.), 27.6 (11.), 42.0 (1.)  
Trefferkreis: 7.40 mm  
Trefferlage: 0.02 mm links, 0.97 mm tief

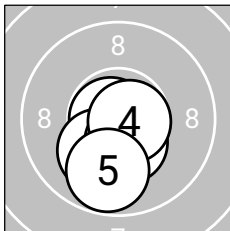
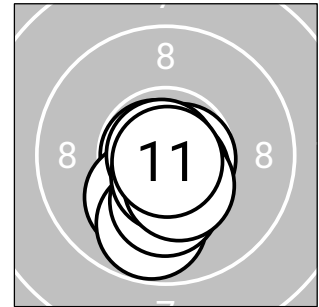

**Serie 1: 51.8** (49)

10.8\*←

10.1↙

10.4\*↘

10.7\*→

9.8↓

beste Teiler: 42.0 (1.), 61.8 (4.), 133.7 (3.)

Trefferkreis: 7.40 mm

Trefferlage: 0.20 mm links, 1.18 mm tief

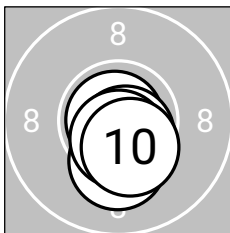

**Serie 2: 52.8** (50)

10.2\*↓

10.9\*←

10.7\*↘

10.6\*↓

10.4\*↘

beste Teiler: 17.1 (7.), 73.7 (8.), 85.0 (9.)

Trefferkreis: 6.39 mm

Trefferlage: 0.13 mm rechts, 0.91 mm tief

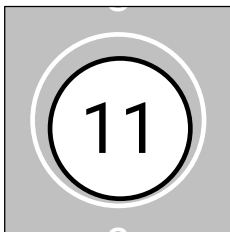

**Serie 3: 10.8** (10)

10.8\*↓

beste Teiler: 27.6 (11.)

Trefferkreis: 4.50 mm

Trefferlage: 0.06 mm rechts, 0.27 mm tief

# ISSF AR Mixed

StandNr: 5

Gratz-Manzl, Doris #70409084

# Mixed Team

Competition

StartNr: 229

06.02.2026 17:15

SG\_Kirchbichl

LG-Kirchbichl\_1

Ergebnis: **308.1** (295)  
 Serien: 103.0 103.9 101.2  
 Zähler: 25 5 0 0 0 0 0 0 0 0 0  
 Innenzehner: 21  
 Weitest: 481 (27.), 422 (29.), 302 (4.)  
 beste Teiler: 38.0 (13.), 42.6 (20.), 45.6 (17.)  
 Trefferkreis: 11.69 mm  
 Trefferlage: 0.14 mm links, 0.23 mm hoch

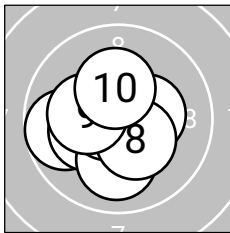
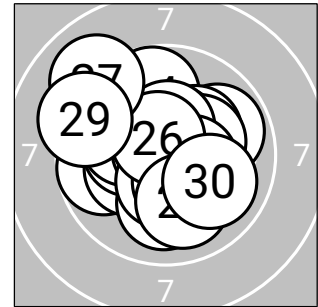

### Serie 1: 103.0 (99)

10.7*↓	10.4*←	10.3*→	9.7←	10.2*←
10.0↓	10.7*←	10.4*↘	10.3*←	10.3*↑

beste Teiler: 58.3 (7.), 58.5 (1.), 146.2 (2.)  
 Trefferkreis: 9.05 mm  
 Trefferlage: 0.63 mm links, 0.27 mm tief

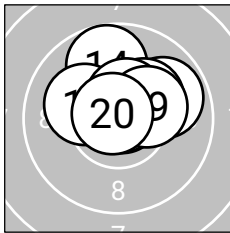

### Serie 2: 103.9 (98)

9.9→	10.7*↗	10.8*↗	9.8↑	10.1←
10.2*↗	10.8*↗	10.5*↗	10.3*→	10.8*↖

beste Teiler: 38.0 (13.), 42.6 (20.), 45.6 (17.)  
 Trefferkreis: 8.84 mm  
 Trefferlage: 0.38 mm rechts, 0.92 mm hoch

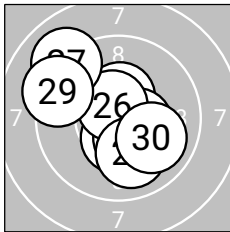

### Serie 3: 101.2 (98)

10.5*↓	10.4*↘	10.5*↘	10.4*↑	10.5*→
10.6*↖	9.0↖	10.0↓	9.3←	10.0↘

beste Teiler: 87.6 (26.), 118.8 (23.), 124.7 (25.)  
 Trefferkreis: 11.69 mm  
 Trefferlage: 0.18 mm links, 0.04 mm hoch



# ISSF AR Mixed

StandNr: 6

Manzl, Robert #70409085

# Mixed Team

Competition

StartNr: 230

06.02.2026 17:16

SG\_Kirchbichl

LG-Kirchbichl\_1

Ergebnis: **309.3** (296)  
 Serien: 103.0 101.8 104.5  
 Zähler: 26 4 0 0 0 0 0 0 0 0  
 Innenzehner: 21  
 Weitest: 397 (16.), 329 (12.), 297 (17.)  
 beste Teiler: 39.0 (29.), 54.1 (6.), 55.4 (11.)  
 Trefferkreis: 10.74 mm  
 Trefferlage: 0.24 mm rechts, 0.12 mm hoch

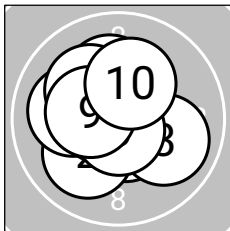
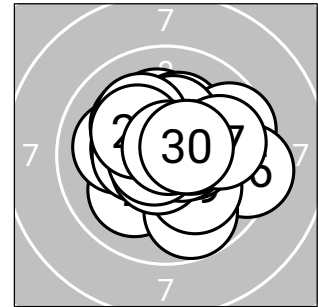

### Serie 1: 103.0 (100)

10.6* ↓	10.1 ↙	10.0 →	10.0 ←	10.6* ←
10.7* ↓	10.2* ↑	10.2* ↘	10.4* ←	10.2* ↑

beste Teiler: 54.1 (6.), 84.3 (5.), 92.3 (1.)  
 Trefferkreis: 9.19 mm  
 Trefferlage: 0.45 mm links, 0.17 mm hoch

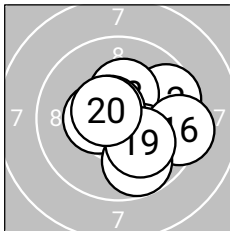

### Serie 2: 101.8 (97)

10.7* ↖	9.6 →	10.3* ↑	10.4* ←	10.2* ↘
9.4 →	9.8 ↓	10.7* ↘	10.1 ↘	10.6* ↘

beste Teiler: 55.4 (11.), 72.9 (18.), 91.2 (20.)  
 Trefferkreis: 9.75 mm  
 Trefferlage: 0.85 mm rechts, 0.20 mm tief

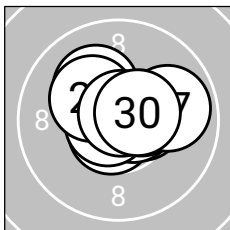

### Serie 3: 104.5 (99)

10.7* ↙	10.1 ↖	10.5* →	10.6* →	10.5* →
10.7* ←	9.9 →	10.2* ↘	10.8* ↑	10.5* →

beste Teiler: 39.0 (29.), 57.0 (26.), 69.3 (21.)  
 Trefferkreis: 8.47 mm  
 Trefferlage: 0.34 mm rechts, 0.39 mm hoch

Ergebnis: **309.9** (296)  
 Serien: 103.9 104.0 102.0  
 Zähler: 26 4 0 0 0 0 0 0 0 0  
 Innenzehner: 21  
 Weitester: 374 (26.), 326 (21.), 323 (7.)  
 beste Teiler: 22.2 (4.), 30.2 (23.), 31.6 (18.)  
 Trefferkreis: 11.48 mm  
 Trefferlage: 0.09 mm rechts, 0.12 mm hoch

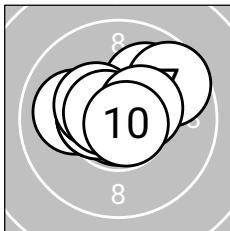
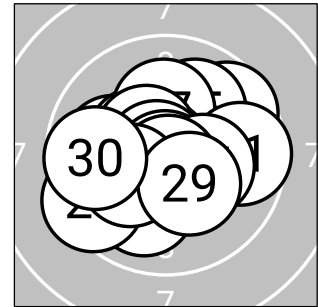

**Serie 1: 103.9** (99)

10.0←	10.5*←	10.0↗	10.9*↓	10.5*←
10.4*↖	9.7↗	10.7*←	10.4*↗	10.8*↘

beste Teiler: 22.2 (4.), 48.5 (10.), 74.6 (8.)  
 Trefferkreis: 9.67 mm  
 Trefferlage: 0.05 mm links, 0.54 mm hoch

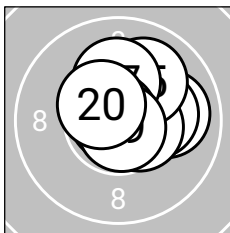

**Serie 2: 104.0** (100)

10.3*→	10.0→	10.2*→	10.5*→	10.0↗
10.7*↖	10.2*↑	10.8*←	10.8*↓	10.5*↖

beste Teiler: 31.6 (18.), 38.9 (19.), 69.6 (16.)  
 Trefferkreis: 7.81 mm  
 Trefferlage: 0.67 mm rechts, 0.57 mm hoch

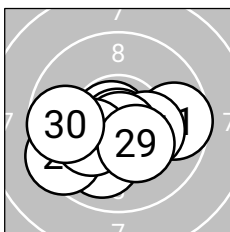

**Serie 3: 102.0** (97)

9.6→	10.8*←	10.8*↓	10.0↘	10.3*→
9.5↖	10.8*↓	10.2*←	10.3*↘	9.7←

beste Teiler: 30.2 (23.), 43.3 (22.), 50.9 (27.)  
 Trefferkreis: 11.26 mm  
 Trefferlage: 0.32 mm links, 0.74 mm tief



Ergebnis: **311.2** (297)  
 Serien: 103.1 104.5 103.6  
 Zähler: 27 3 0 0 0 0 0 0 0 0 0  
 Innenzehner: 21  
 Weitester: 338 (5.), 282 (27.), 254 (8.)  
 beste Teiler: 38.0 (2.), 47.4 (22.), 58.1 (20.)  
 Trefferkreis: 10.18 mm  
 Trefferlage: 0.43 mm links, 0.12 mm hoch

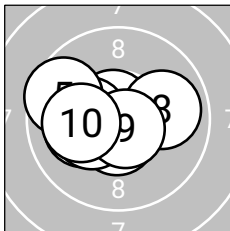
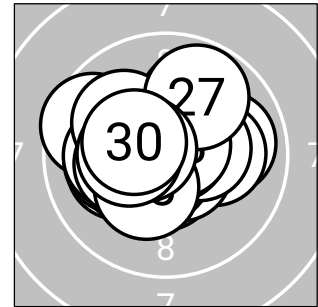

**Serie 1: 103.1** (98)

10.1 ←	10.8* ↓	10.7* ↖	10.3* ←	9.6 ←
10.6* ↓	10.3* ←	9.9 →	10.7* ↓	10.1 ←

beste Teiler: 38.0 (2.), 63.5 (3.), 70.2 (9.)  
 Trefferkreis: 10.18 mm  
 Trefferlage: 0.81 mm links, 0.07 mm tief

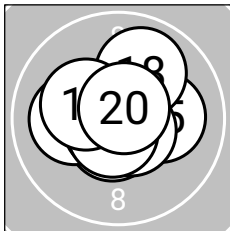

**Serie 2: 104.5** (100)

10.6* ↓	10.7* ↓	10.1 ←	10.7* ↓	10.1 →
10.6* ↓	10.7* ↓	10.0 ↗	10.3* ←	10.7* ↗

beste Teiler: 58.1 (20.), 59.9 (12.), 60.4 (14.)  
 Trefferkreis: 8.80 mm  
 Trefferlage: 0.04 mm links, 0.04 mm hoch

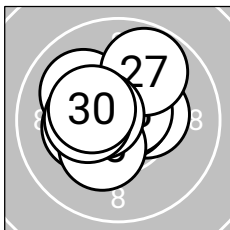

**Serie 3: 103.6** (99)

10.4* →	10.8* ↗	10.7* ↗	10.3* ←	10.3* ↓
10.0 ↖	9.8 ↗	10.6* ←	10.3* ←	10.4* ←

beste Teiler: 47.4 (22.), 69.6 (23.), 95.6 (28.)  
 Trefferkreis: 8.92 mm  
 Trefferlage: 0.45 mm links, 0.40 mm hoch

Ergebnis: **310.8** (294)  
 Serien: 103.4 104.8 102.6  
 Zähler: 24 6 0 0 0 0 0 0 0 0  
 Innenezehner: 22  
 Weitester: 321 (23.), 318 (29.), 281 (30.)  
 beste Teiler: 5.6 (22.), 6.7 (26.), 22.3 (28.)  
 Trefferkreis: 10.84 mm  
 Trefferlage: 0.08 mm rechts, 0.54 mm hoch

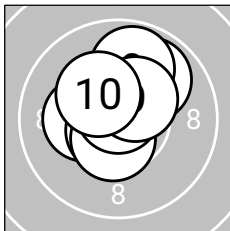
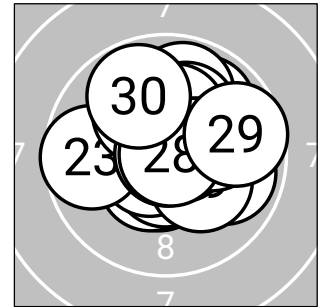

**Serie 1: 103.4** (98)

10.2\*← 9.9↗ 10.4\*↗  
 10.5\*↓ 10.8\*↑ 9.9↑  
 beste Teiler: 42.0 (7.), 81.4 (4.), 107.7 (6.)  
 Trefferkreis: 8.48 mm  
 Trefferlage: 0.05 mm links, 0.82 mm hoch

10.6\*↘ 10.4\*↖  
 10.4\*↗ 10.3\*↖

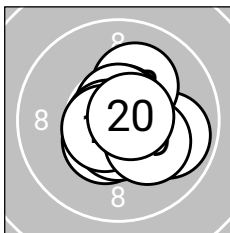

**Serie 2: 104.8** (99)

9.9→ 10.2\*↗ 10.7\*↑  
 10.5\*↘ 10.6\*↓ 10.6\*↖  
 beste Teiler: 52.8 (15.), 67.3 (20.), 67.4 (13.)  
 Trefferkreis: 8.16 mm  
 Trefferlage: 0.38 mm rechts, 0.09 mm tief

10.7\*↑ 10.7\*↖  
 10.2\*↘ 10.7\*→

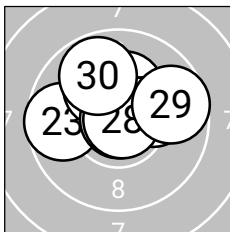

**Serie 3: 102.6** (97)

10.3\*↖ 10.9\*↗ 9.7←  
 10.9\*↗ 10.2\*↑ 10.9\*→  
 beste Teiler: 5.6 (22.), 6.7 (26.), 22.3 (28.)  
 Trefferkreis: 10.84 mm  
 Trefferlage: 0.08 mm links, 0.89 mm hoch

10.1↖ 10.1→  
 9.7→ 9.8↖

Ergebnis: **306.3** (291)  
 Serien: 102.2 102.9 101.2  
 Zähler: 21 9 0 0 0 0 0 0 0 0 0  
 Innenzehner: 18  
 Weitest: 401 (2.), 319 (24.), 299 (27.)  
 beste Teiler: 26.0 (6.), 65.5 (16.), 72.1 (11.)  
 Trefferkreis: 11.19 mm  
 Trefferlage: 0.02 mm links, 0.25 mm hoch

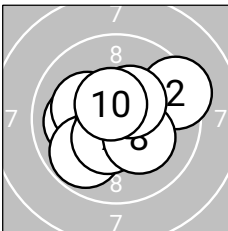
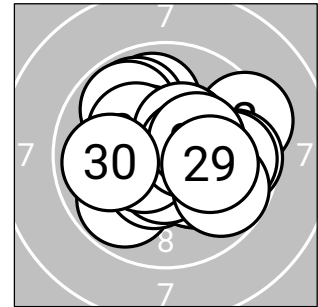

**Serie 1: 102.2** (98)

10.0←	9.3→	10.5*←	10.2*←	9.8↙
10.8*←	10.4*↘	10.2*↘	10.4*↗	10.6*↖

beste Teiler: 26.0 (6.), 97.1 (10.), 106.1 (3.)  
 Trefferkreis: 11.16 mm  
 Trefferlage: 0.22 mm links, 0.02 mm tief

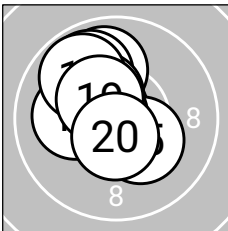

**Serie 2: 102.9** (97)

10.7*↖	9.9↑	9.9↖	10.4*↖	10.3*↘
10.7*←	10.1←	9.9↖	10.4*↖	10.6*↓

beste Teiler: 65.5 (16.), 72.1 (11.), 93.1 (20.)  
 Trefferkreis: 8.92 mm  
 Trefferlage: 0.75 mm links, 0.78 mm hoch

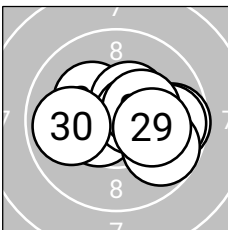

**Serie 3: 101.2** (96)

10.5*↖	10.2*↖	10.4*↗	9.7→	9.8→
10.5*→	9.8↘	10.3*↗	10.1→	9.9←

beste Teiler: 101.9 (26.), 108.4 (21.), 134.7 (23.)  
 Trefferkreis: 10.28 mm  
 Trefferlage: 0.89 mm rechts, 0.01 mm hoch



Ergebnis: **317.1** (299)  
 Serien: 104.8 105.5 106.8  
 Zähler: 29 1 0 0 0 0 0 0 0 0  
 Innenzehner: 26  
 Weitester: 285 (12.), 243 (5.), 205 (18.)  
 beste Teiler: 6.3 (14.), 6.4 (21.), 10.0 (24.)  
 Trefferkreis: 8.96 mm  
 Trefferlage: 0.47 mm rechts, 0.03 mm hoch

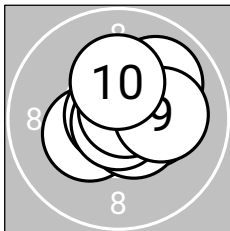
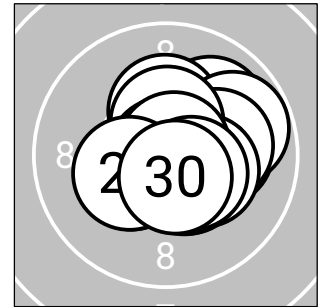

**Serie 1: 104.8** (100)

10.3*↙	10.3*→	10.6*↘	10.8*↖	10.0↗
10.8*↗	10.9*↓	10.7*↗	10.1→	10.3*↑

beste Teiler: 17.0 (7.), 36.7 (4.), 44.6 (6.)  
 Trefferkreis: 8.43 mm  
 Trefferlage: 0.49 mm rechts, 0.30 mm hoch

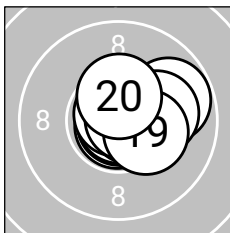

**Serie 2: 105.5** (99)

10.8*↓	9.8→	10.9*↘	10.9*↘	10.8*↖
10.7*→	10.8*→	10.1→	10.3*↘	10.4*↑

beste Teiler: 6.3 (14.), 14.3 (13.), 29.6 (11.)  
 Trefferkreis: 7.53 mm  
 Trefferlage: 0.73 mm rechts, 0.20 mm hoch

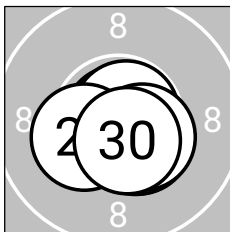

**Serie 3: 106.8** (100)

10.9*↖	10.9*↘	10.9*↘	10.9*↓	10.8*↗
10.5*↘	10.5*↘	10.5*↘	10.3*↖	10.6*↘

beste Teiler: 6.4 (21.), 10.0 (24.), 25.0 (23.)  
 Trefferkreis: 6.95 mm  
 Trefferlage: 0.19 mm rechts, 0.41 mm tief



**ISSF AR Mixed Final**

StandNr: C

**Lettenbichler, Elisabeth** #70404040**Mixed Team**

Medal Match

**StartNr: 238**

06.02.2026 19:24

SG\_Breitenbach

SG Breitenbach 1

Ergebnis: **167.7** (160)  
 Serien: 52.3 52.1 53.1 10.2  
 Zähler: 16 0 0 0 0 0 0 0 0 0  
 Innenzehner: 15  
 Weitest: 217 (4.), 189 (16.), 188 (7.)  
 beste Teiler: 14.0 (14.), 53.6 (2.), 56.1 (8.)  
 Trefferkreis: 8.37 mm  
 Trefferlage: 0.18 mm links, 0.46 mm tief

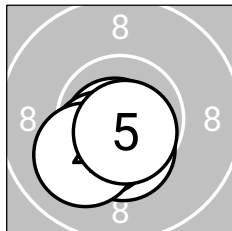
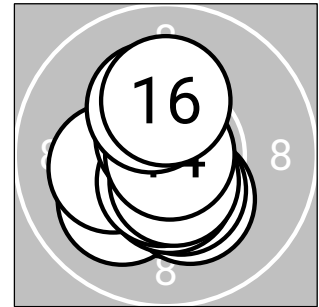
**Serie 1: 52.3** (50)

10.4\*↓

10.7\*↓

10.4\*↖

10.1↖

10.7\*↓

beste Teiler: 53.6 (2.), 61.6 (5.), 130.6 (1.)  
 Trefferkreis: 6.48 mm  
 Trefferlage: 0.44 mm links, 0.99 mm tief

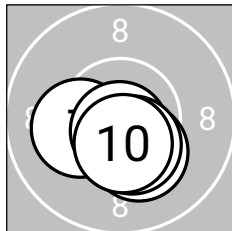
**Serie 2: 52.1** (50)

10.3\*↘

10.2\*←

10.7\*↓

10.4\*↓

10.5\*↓

beste Teiler: 56.1 (8.), 115.7 (10.), 132.5 (9.)  
 Trefferkreis: 7.39 mm  
 Trefferlage: 0.07 mm links, 0.97 mm tief

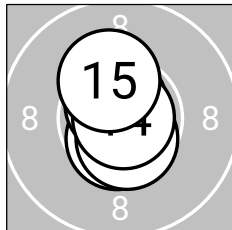
**Serie 3: 53.1** (50)

10.6\*↓

10.6\*↓

10.7\*↖

10.9\*→

10.3\*↖

beste Teiler: 14.0 (14.), 67.0 (13.), 92.2 (11.)  
 Trefferkreis: 7.17 mm  
 Trefferlage: 0.08 mm links, 0.09 mm hoch

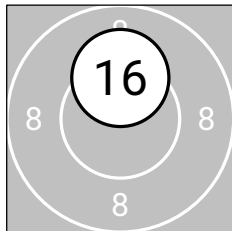
**Serie 4: 10.2** (10)

10.2\*↑

beste Teiler: 189.0 (16.)  
 Trefferkreis: 4.50 mm  
 Trefferlage: 0.00 mm, 1.89 mm hoch

# ISSF AR Mixed

StandNr: 14

Felderer, Raimund #70404027

# Mixed Team

Competition

StartNr: 239

06.02.2026 17:17

SG\_Breitenbach

SG Breitenbach 1

Ergebnis: **316.1** (298)  
 Serien: 104.9 106.0 105.2  
 Zähler: 28 2 0 0 0 0 0 0 0 0  
 Innenzehner: 27  
 Weitest: 302 (17.), 271 (28.), 206 (4.)  
 beste Teiler: 14.7 (20.), 16.0 (27.), 23.7 (14.)  
 Trefferkreis: 10.23 mm  
 Trefferlage: 0.13 mm links, 0.10 mm hoch

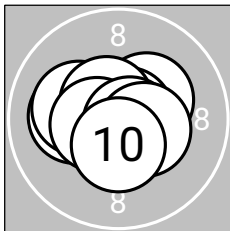
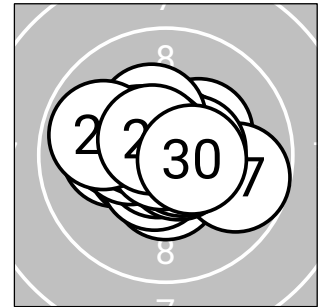

### Serie 1: 104.9 (100)

10.3*↗	10.8*↘	10.8*↗	10.1←	10.2*←
10.6*↖	10.5*←	10.7*↘	10.4*↘	10.5*↓

beste Teiler: 40.7 (2.), 44.7 (3.), 60.0 (8.)  
 Trefferkreis: 8.02 mm  
 Trefferlage: 0.18 mm links, 0.01 mm tief

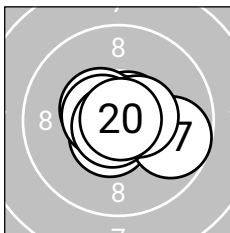

### Serie 2: 106.0 (99)

10.8*↗	10.7*↗	10.6*↘	10.9*↗	10.5*↖
10.6*↖	9.7↘	10.8*↘	10.5*↘	10.9*↗

beste Teiler: 14.7 (20.), 23.7 (14.), 39.5 (11.)  
 Trefferkreis: 8.66 mm  
 Trefferlage: 0.23 mm rechts, 0.00 mm

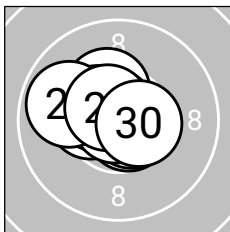

### Serie 3: 105.2 (99)

10.4*←	10.3*↖	10.7*↘	10.7*↖	10.5*↖
10.7*↘	10.9*←	9.9←	10.6*↖	10.5*↘

beste Teiler: 16.0 (27.), 54.6 (24.), 66.8 (23.)  
 Trefferkreis: 8.30 mm  
 Trefferlage: 0.44 mm links, 0.33 mm hoch



# ISSF AR Mixed Final

StandNr: D

Felderer, Raimund #70404027

# Mixed Team

Medal Match

StartNr: 239

06.02.2026 19:24

SG\_Breitenbach

SG Breitenbach 1

Ergebnis: **166.5** (158)  
Serien: 51.9 52.9 51.2 10.5  
Zähler: 14 2 0 0 0 0 0 0 0 0  
Innenzehner: 13  
Weiteste: 315 (14.), 257 (2.), 207 (3.)  
beste Teiler: 43.6 (8.), 57.0 (6.), 57.1 (1.)  
Trefferkreis: 9.34 mm  
Trefferlage: 0.39 mm links, 0.38 mm tief

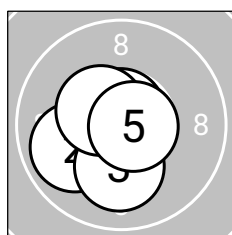
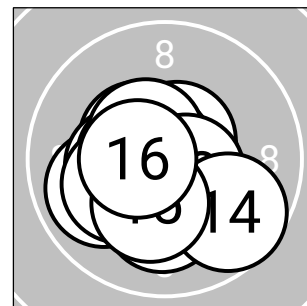

## Serie 1: 51.9 (49)

10.7\*↑

9.9↙

10.1↓

10.5\*↖

10.7\*→

beste Teiler: 57.1 (1.), 60.5 (5.), 125.6 (4.)  
Trefferkreis: 7.60 mm  
Trefferlage: 0.57 mm links, 0.39 mm tief

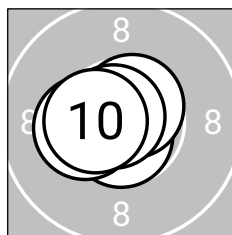

## Serie 2: 52.9 (50)

10.7\*↓

10.6\*↗

10.8\*↖

10.3\*←

10.5\*←

beste Teiler: 43.6 (8.), 57.0 (6.), 85.1 (7.)  
Trefferkreis: 6.75 mm  
Trefferlage: 0.51 mm links, 0.04 mm hoch

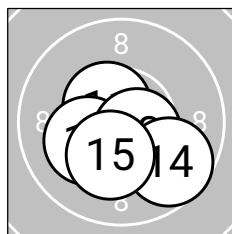

## Serie 3: 51.2 (49)

10.5\*↖

10.2\*↙

10.6\*↗

9.7↘

10.2\*↓

beste Teiler: 96.5 (13.), 109.0 (11.), 177.0 (15.)  
Trefferkreis: 8.87 mm  
Trefferlage: 0.04 mm rechts, 0.87 mm tief

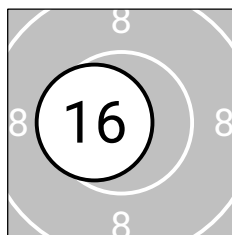

## Serie 4: 10.5 (10)

10.5\*←

beste Teiler: 104.0 (16.)  
Trefferkreis: 4.50 mm  
Trefferlage: 1.04 mm links, 0.01 mm hoch

Ergebnis: **313.4** (296)  
 Serien: 103.0 105.7 104.7  
 Zähler: 26 4 0 0 0 0 0 0 0 0  
 Innenezehner: 25  
 Weitest: 432 (25.), 291 (6.), 281 (2.)  
 beste Teiler: 24.0 (20.), 26.0 (21.), 27.0 (16.)  
 Trefferkreis: 10.73 mm  
 Trefferlage: 0.15 mm rechts, 0.24 mm hoch

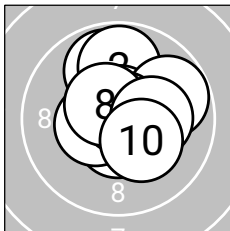
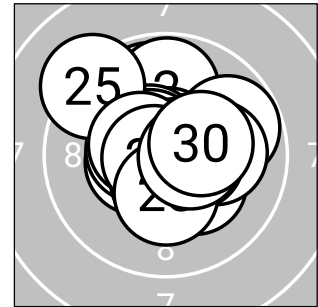

**Serie 1: 103.0** (97)

9.9↑	9.8↑	10.6*↓	10.4*←	10.7*↑
9.8→	10.8*↗	10.5*↖	10.2*→	10.3*↘

beste Teiler: 39.4 (7.), 66.3 (5.), 96.0 (3.)  
 Trefferkreis: 8.80 mm  
 Trefferlage: 0.34 mm rechts, 0.59 mm hoch

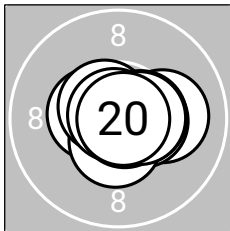

**Serie 2: 105.7** (100)

10.5*←	10.1→	10.5*→	10.5*↓	10.6*↖
10.8*↖	10.5*→	10.8*↗	10.5*→	10.9*→

beste Teiler: 24.0 (20.), 27.0 (16.), 33.6 (18.)  
 Trefferkreis: 7.83 mm  
 Trefferlage: 0.36 mm rechts, 0.01 mm tief

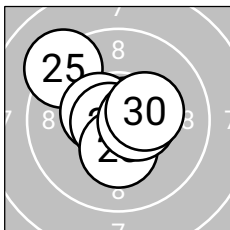

**Serie 3: 104.7** (99)

10.8*←	10.8*→	10.8*↓	10.8*↖	9.2↖
10.5*↖	10.7*←	10.3*↓	10.5*→	10.3*→

beste Teiler: 26.0 (21.), 31.1 (24.), 44.2 (22.)  
 Trefferkreis: 10.13 mm  
 Trefferlage: 0.23 mm links, 0.15 mm hoch



Ergebnis: **307.7 (293)**  
 Serien: 103.1 102.1 102.5  
 Zähler: 23 7 0 0 0 0 0 0 0 0  
 Innenezehner: 19  
 Weitest: 428 (22.), 424 (5.), 328 (2.)  
 beste Teiler: 2.2 (29.), 11.4 (18.), 13.8 (4.)  
 Trefferkreis: 11.15 mm  
 Trefferlage: 0.79 mm links, 0.39 mm tief

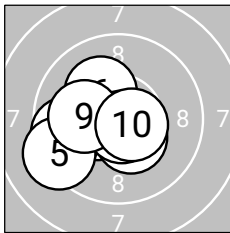
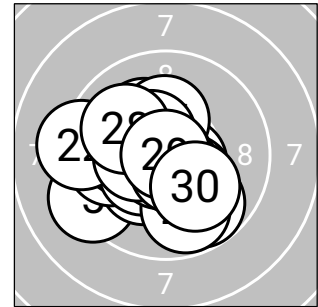

**Serie 1: 103.1 (98)**

10.4*←	9.6←	10.9*↘	10.9*↘	9.3←
10.2*↖	10.4*↘	10.7*↘	10.1←	10.6*↗

beste Teiler: 13.8 (4.), 23.0 (3.), 54.6 (8.)  
 Trefferkreis: 9.43 mm  
 Trefferlage: 0.94 mm links, 0.38 mm tief

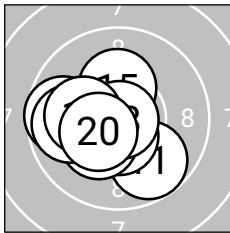

**Serie 2: 102.1 (97)**

9.8↘	9.7←	10.5*↓	10.3*↗	10.2*↑
10.4*←	9.8←	10.9*↘	10.1←	10.4*←

beste Teiler: 11.4 (18.), 101.1 (13.), 138.3 (20.)  
 Trefferkreis: 10.06 mm  
 Trefferlage: 0.98 mm links, 0.41 mm tief

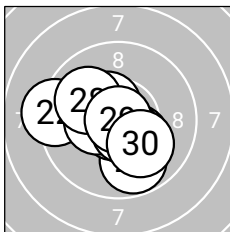

**Serie 3: 102.5 (98)**

10.3*↘	9.2←	10.5*↖	9.8↘	10.7*↘
10.4*←	10.6*↘	10.0←	10.9*↖	10.1↘

beste Teiler: 2.2 (29.), 53.5 (25.), 82.3 (27.)  
 Trefferkreis: 10.65 mm  
 Trefferlage: 0.46 mm links, 0.37 mm tief



Ergebnis: **303.1** (290)  
 Serien: 100.7 100.3 102.1  
 Zähler: 21 8 1 0 0 0 0 0 0 0  
 Innenezehner: 16  
 Weitester: 701 (11.), 452 (8.), 366 (23.)  
 beste Teiler: 40.3 (27.), 42.1 (25.), 69.0 (5.)  
 Trefferkreis: 14.61 mm  
 Trefferlage: 0.23 mm links, 0.15 mm hoch

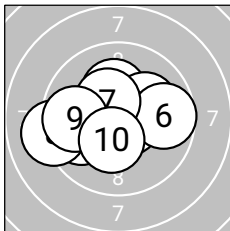
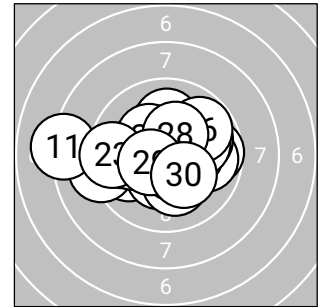

**Serie 1: 100.7** (96)

10.5\*← 10.2\*↑ 10.1↗ 9.9← 10.7\*↘  
 9.7→ 10.4\*↖ 9.1← 9.8← 10.3\*↓

beste Teiler: 69.0 (5.), 101.1 (1.), 141.8 (7.)  
 Trefferkreis: 12.12 mm  
 Trefferlage: 0.68 mm links, 0.04 mm hoch

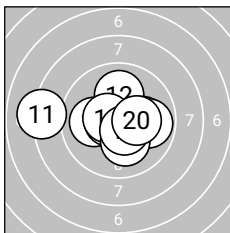

**Serie 2: 100.3** (97)

8.1← 10.0↑ 10.1← 10.6\*← 10.5\*←  
 10.1→ 9.9→ 10.2\*↓ 10.5\*↓ 10.3\*→

beste Teiler: 85.5 (14.), 101.4 (15.), 106.0 (19.)  
 Trefferkreis: 14.24 mm  
 Trefferlage: 0.32 mm links, 0.02 mm tief

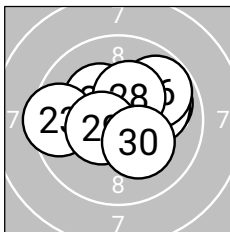

**Serie 3: 102.1** (97)

9.9↗ 10.3\*↖ 9.5← 10.0→ 10.8\*↓  
 9.8↗ 10.8\*↗ 10.3\*↑ 10.5\*← 10.2\*↘

beste Teiler: 40.3 (27.), 42.1 (25.), 114.0 (29.)  
 Trefferkreis: 10.72 mm  
 Trefferlage: 0.30 mm rechts, 0.42 mm hoch



Ergebnis: **316.8** (298)  
 Serien: 105.6 104.2 107.0  
 Zähler: 28 2 0 0 0 0 0 0 0 0  
 Innenzehner: 27  
 Weitest: 329 (13.), 289 (1.), 212 (17.)  
 beste Teiler: 9.2 (30.), 32.6 (9.), 38.0 (10.)  
 Trefferkreis: 8.87 mm  
 Trefferlage: 0.35 mm links, 0.07 mm tief

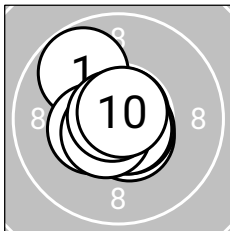
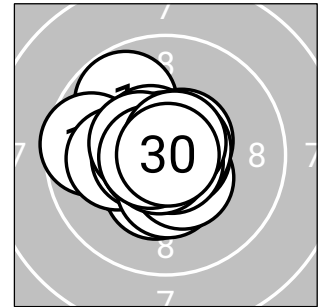

**Serie 1: 105.6** (99)

9.8 ↖ 10.8\* ↗ 10.5\* ↘ 10.7\* ↘ 10.7\* ↘  
 10.5\* ↙ 10.4\* ↙ 10.6\* ↘ 10.8\* ↙ 10.8\* ↗  
 beste Teiler: 32.6 (9.), 38.0 (10.), 38.2 (2.)  
 Trefferkreis: 8.40 mm  
 Trefferlage: 0.30 mm links, 0.05 mm tief

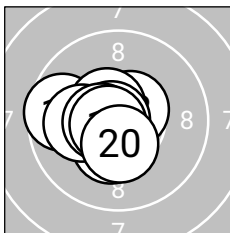

**Serie 2: 104.2** (99)

10.6\* ↙ 10.6\* ↗ 9.6 ↖ 10.4\* ↘ 10.5\* ↖  
 10.8\* ↙ 10.1 ↖ 10.5\* ↖ 10.7\* ↙ 10.4\* ↘  
 beste Teiler: 40.1 (16.), 63.9 (19.), 80.1 (11.)  
 Trefferkreis: 8.55 mm  
 Trefferlage: 0.81 mm links, 0.20 mm tief

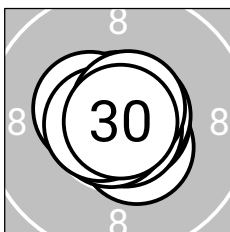

**Serie 3: 107.0** (100)

10.5\* ↘ 10.7\* → 10.7\* → 10.7\* ↑ 10.5\* ↖  
 10.8\* ↘ 10.8\* ↙ 10.7\* ↖ 10.7\* ↗ 10.9\* →  
 beste Teiler: 9.2 (30.), 40.3 (26.), 43.1 (27.)  
 Trefferkreis: 6.89 mm  
 Trefferlage: 0.05 mm rechts, 0.02 mm hoch

# ISSF AR Mixed

StandNr: 19

Trenkwalder, Ivana #70412124

# Mixed Team

Competition

StartNr: 244

06.02.2026 17:13

SG\_Kundl

SG Kundl 2

Ergebnis: **313.1** (296)  
Serien: 105.0 104.6 103.5  
Zähler: 26 4 0 0 0 0 0 0 0 0  
Innenzehner: 25  
Weiteste: 398 (14.), 378 (22.), 373 (24.)  
beste Teiler: 14.0 (4.), 39.2 (18.), 42.4 (7.)  
Trefferkreis: 12.21 mm  
Trefferlage: 0.10 mm links, 0.08 mm hoch

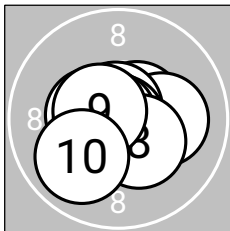
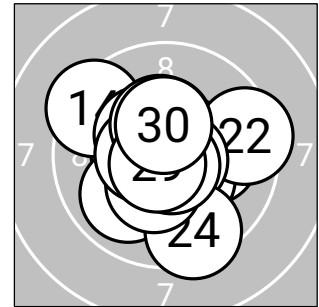

### Serie 1: 105.0 (99)

10.5*↗	10.1→	10.8*↑	10.9*↓	10.4*←
10.6*←	10.8*←	10.4*↘	10.6*←	9.9↙
beste Teiler:	14.0 (4.), 42.4 (7.), 49.7 (3.)			
Trefferkreis:	8.72 mm			
Trefferlage:	0.13 mm links, 0.15 mm tief			

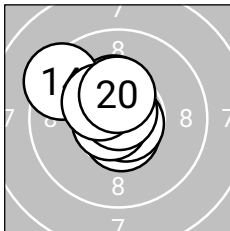

### Serie 2: 104.6 (99)

10.6*↓	10.4*↑	10.8*↖	9.4↖	10.7*↘
10.7*↙	10.4*↑	10.8*↑	10.4*↖	10.4*↑
beste Teiler:	39.2 (18.), 50.6 (13.), 52.3 (16.)			
Trefferkreis:	9.15 mm			
Trefferlage:	0.51 mm links, 0.66 mm hoch			

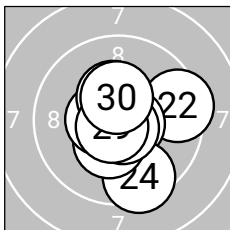

### Serie 3: 103.5 (98)

10.8*↓	9.4→	10.7*↘	9.5↓	10.4*↙
10.7*↘	10.5*←	10.4*↑	10.7*↙	10.4*↑
beste Teiler:	46.0 (21.), 55.0 (26.), 55.8 (29.)			
Trefferkreis:	10.07 mm			
Trefferlage:	0.34 mm rechts, 0.26 mm tief			



Ergebnis: **310.4** (296)  
 Serien: 101.8 103.5 105.1  
 Zähler: 26 4 0 0 0 0 0 0 0 0  
 Innenezehner: 24  
 Weitestе: 351 (9.), 339 (6.), 281 (13.)  
 beste Teiler: 24.0 (4.), 41.6 (23.), 58.1 (26.)  
 Trefferkreis: 10.74 mm  
 Trefferlage: 0.27 mm rechts, 0.33 mm hoch

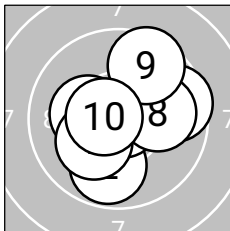
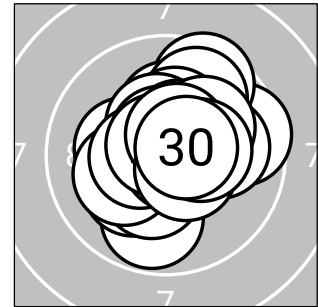

**Serie 1: 101.8** (97)

10.7*←	9.8↓	10.2*←	10.9*→	10.3*↗
9.6→	10.2*↙	10.0→	9.5↗	10.6*←

beste Teiler: 24.0 (4.), 67.1 (1.), 83.8 (10.)  
 Trefferkreis: 10.74 mm  
 Trefferlage: 0.36 mm rechts, 0.16 mm hoch

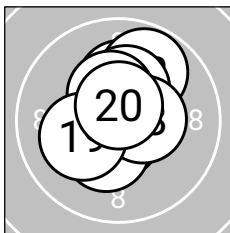

**Serie 2: 103.5** (99)

10.7*↓	10.2*↑	9.8↗	10.3*↑	10.4*↑
10.6*↙	10.3*↙	10.4*→	10.2*←	10.6*↑

beste Teiler: 72.1 (11.), 78.0 (20.), 78.2 (16.)  
 Trefferkreis: 9.07 mm  
 Trefferlage: 0.01 mm links, 0.44 mm hoch

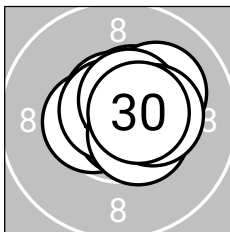

**Serie 3: 105.1** (100)

10.5*↗	10.5*←	10.8*↘	10.1↗	10.6*↑
10.7*↖	10.5*↗	10.5*↘	10.3*→	10.6*→

beste Teiler: 41.6 (23.), 58.1 (26.), 80.7 (25.)  
 Trefferkreis: 7.57 mm  
 Trefferlage: 0.47 mm rechts, 0.40 mm hoch

Ergebnis: **314.7** (296)  
 Serien: 106.4 102.8 105.5  
 Zähler: 26 4 0 0 0 0 0 0 0 0  
 Innenzehner: 26  
 Weitestе: 323 (20.), 269 (12.), 264 (15.)  
 beste Teiler: 12.8 (2.), 13.4 (10.), 15.5 (13.)  
 Trefferkreis: 10.09 mm  
 Trefferlage: 0.16 mm rechts, 0.17 mm tief

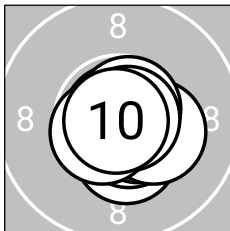
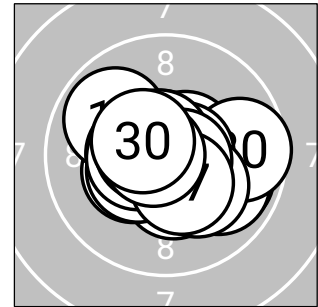

**Serie 1: 106.4** (100)

10.6*↘	10.9*↖	10.4*↓	10.6*↘	10.6*↘
10.3*↘	10.7*↗	10.8*→	10.6*↖	10.9*↖

beste Teiler: 12.8 (2.), 13.4 (10.), 40.0 (8.)  
 Trefferkreis: 6.71 mm  
 Trefferlage: 0.37 mm rechts, 0.37 mm tief

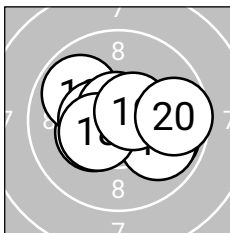

**Serie 2: 102.8** (96)

10.3*↖	9.9↖	10.9*↗	10.5*←	9.9↘
10.7*↖	9.9↘	10.4*↖	10.6*↗	9.7→

beste Teiler: 15.5 (13.), 58.9 (16.), 100.1 (19.)  
 Trefferkreis: 10.09 mm  
 Trefferlage: 0.27 mm rechts, 0.04 mm tief

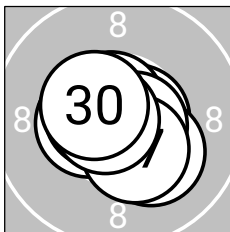

**Serie 3: 105.5** (100)

10.5*←	10.7*→	10.7*↖	10.5*←	10.2*↘
10.7*↘	10.4*↘	10.6*←	10.7*←	10.5*↖

beste Teiler: 54.0 (29.), 67.4 (26.), 67.5 (23.)  
 Trefferkreis: 7.56 mm  
 Trefferlage: 0.15 mm links, 0.12 mm tief



**ISSF AR Mixed**

StandNr: 22

**Schwentner, Jochen** #80001989**Mixed Team**

Competition

**StartNr: 247**

06.02.2026 17:13

TIR|BezKufstein|Walchsee

Walchsee 2

Ergebnis: **300.8** (286)  
 Serien: 102.6 99.3 98.9  
 Zähler: 16 14 0 0 0 0 0 0 0 0  
 Innenezehner: 13  
 Weitestе: 452 (22.), 417 (12.), 405 (30.)  
 beste Teiler: 25.2 (7.), 25.2 (10.), 43.1 (1.)  
 Trefferkreis: 12.73 mm  
 Trefferlage: 0.91 mm rechts, 0.50 mm tief

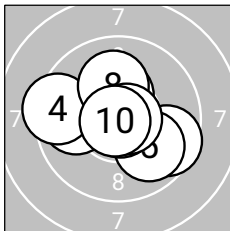
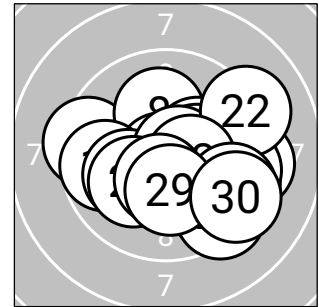
**Serie 1: 102.6** (96)

10.8*↑	9.9←	9.6➡	9.4←	9.9↘
10.4*↑	10.9*↘	10.1↑	10.7*➡	10.9*↙

beste Teiler: 25.2 (7.), 25.2 (10.), 43.1 (1.)  
 Trefferkreis: 11.71 mm  
 Trefferlage: 0.13 mm links, 0.11 mm hoch

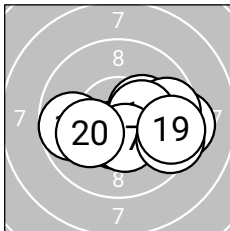
**Serie 2: 99.3** (95)

10.3*➡	9.3➡	9.7←	9.7➡	10.5*↓
10.3*➡	10.4*↓	9.5➡	9.5➡	10.1←

beste Teiler: 110.6 (15.), 135.3 (17.), 156.5 (16.)  
 Trefferkreis: 11.67 mm  
 Trefferlage: 1.27 mm rechts, 0.50 mm tief

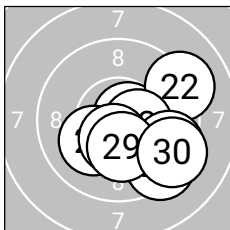
**Serie 3: 98.9** (95)

10.7*➡	9.1➡	10.4*➡	10.1↙	9.6↘
9.4↘	10.5*↓	9.5➡	10.3*↓	9.3↘

beste Teiler: 64.1 (21.), 123.9 (27.), 126.6 (23.)  
 Trefferkreis: 11.11 mm  
 Trefferlage: 1.59 mm rechts, 1.12 mm tief

Ergebnis: **307.8** (294)  
 Serien: 102.0 103.6 102.2  
 Zähler: 24 6 0 0 0 0 0 0 0 0  
 Innenzehner: 19  
 Weitest: 363 (25.), 330 (8.), 290 (24.)  
 beste Teiler: 21.0 (29.), 40.8 (1.), 62.0 (18.)  
 Trefferkreis: 9.35 mm  
 Trefferlage: 0.82 mm links, 0.87 mm hoch

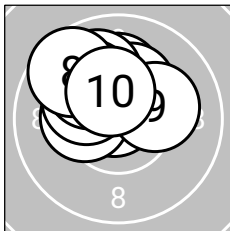
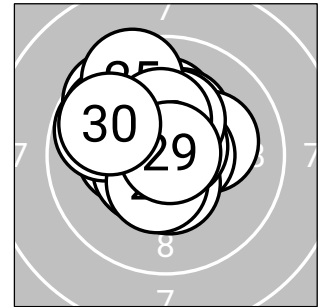

**Serie 1: 102.0** (99)

10.8*↖	10.3*←	10.2*↖	10.1↑	10.3*↗
10.0↖	10.1↖	9.6↖	10.2*→	10.4*↖

beste Teiler: 40.8 (1.), 143.6 (10.), 169.2 (2.)  
 Trefferkreis: 9.02 mm  
 Trefferlage: 0.62 mm links, 1.33 mm hoch

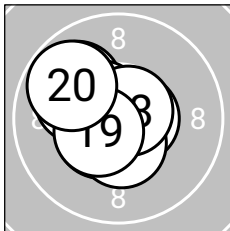

**Serie 2: 103.6** (98)

10.6*→	9.9↖	10.5*↖	10.1↖	10.5*↖
10.5*↖	10.5*↓	10.7*↗	10.5*↖	9.8↖

beste Teiler: 62.0 (18.), 81.0 (11.), 104.3 (16.)  
 Trefferkreis: 8.30 mm  
 Trefferlage: 0.83 mm links, 0.18 mm hoch

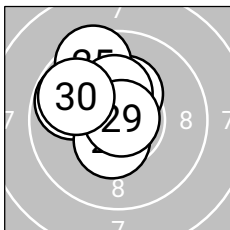

**Serie 3: 102.2** (97)

10.3*↗	10.6*↖	10.1↖	9.8↖	9.5↖
10.4*↖	10.5*↓	10.3*↑	10.9*→	9.8↖

beste Teiler: 21.0 (29.), 94.8 (22.), 123.9 (27.)  
 Trefferkreis: 9.13 mm  
 Trefferlage: 1.01 mm links, 1.09 mm hoch



Ergebnis: **300.5** (284)  
 Serien: 102.1 100.2 98.2  
 Zähler: 15 14 1 0 0 0 0 0 0 0  
 Innenezehner: 12  
 Weitester: 553 (20.), 439 (25.), 386 (17.)  
 beste Teiler: 25.0 (13.), 26.4 (14.), 33.7 (8.)  
 Trefferkreis: 13.54 mm  
 Trefferlage: 0.38 mm rechts, 0.45 mm hoch

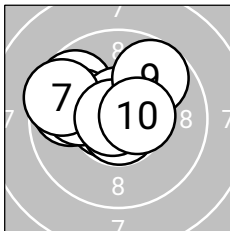
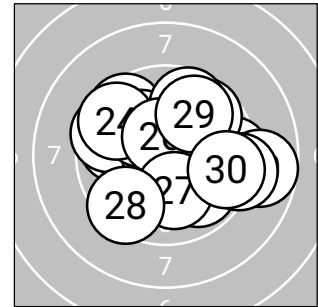

**Serie 1: 102.1** (96)

9.8 ←	10.7* ←	9.7 ↖	10.8* ↓	10.0 ←
10.6* ↑	9.5 ←	10.8* ←	9.7 ↗	10.5* →

beste Teiler: 33.7 (8.), 45.3 (4.), 70.0 (2.)  
 Trefferkreis: 9.83 mm  
 Trefferlage: 0.88 mm links, 0.73 mm hoch

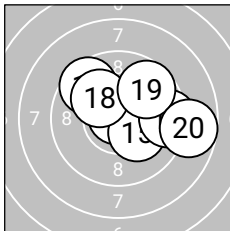

**Serie 2: 100.2** (95)

10.4* ↗	10.4* →	10.9* ↑	10.8* ↖	10.2* ↘
9.6 ↖	9.4 →	10.1 ↖	9.7 ↗	8.7 →

beste Teiler: 25.0 (13.), 26.4 (14.), 140.9 (12.)  
 Trefferkreis: 12.98 mm  
 Trefferlage: 1.13 mm rechts, 0.62 mm hoch

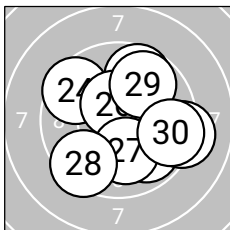

**Serie 3: 98.2** (93)

9.9 ↘	9.7 ↗	10.4* →	9.6 ↖	9.2 →
10.5* ↑	10.1 ↓	9.5 ↖	9.8 ↗	9.5 →

beste Teiler: 112.3 (26.), 133.4 (23.), 212.9 (27.)  
 Trefferkreis: 12.38 mm  
 Trefferlage: 0.88 mm rechts, 0.00 mm



Ergebnis: **312.1** (299)  
 Serien: 104.4 105.0 102.7  
 Zähler: 29 1 0 0 0 0 0 0 0 0  
 Innenzehner: 23  
 Weitest: 451 (25.), 232 (26.), 220 (30.)  
 beste Teiler: 7.0 (17.), 23.3 (21.), 48.6 (4.)  
 Trefferkreis: 9.68 mm  
 Trefferlage: 0.85 mm links, 0.25 mm tief

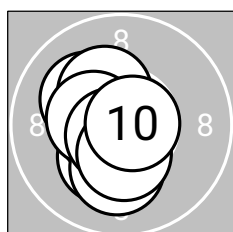
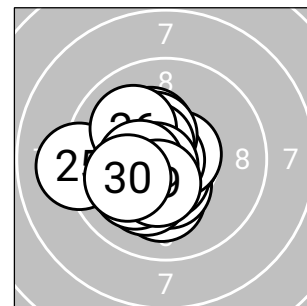

**Serie 1: 104.4** (100)

10.1 ↖	10.3* ↖	10.3* ↘	10.8* ↓	10.6* ↖
10.4* ↖	10.1 ↓	10.7* ↘	10.4* ↓	10.7* →

beste Teiler: 48.6 (4.), 53.4 (10.), 64.6 (8.)  
 Trefferkreis: 8.09 mm  
 Trefferlage: 0.51 mm links, 0.30 mm tief

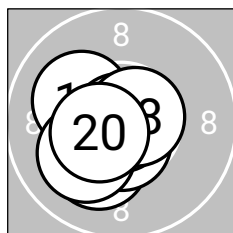

**Serie 2: 105.0** (100)

10.6* ↖	10.2* ↘	10.6* ↘	10.7* ↖	10.6* ↓
10.1 ↖	10.9* ↖	10.7* →	10.1 ↖	10.5* ↖

beste Teiler: 7.0 (17.), 69.0 (18.), 69.9 (14.)  
 Trefferkreis: 7.57 mm  
 Trefferlage: 0.66 mm links, 0.47 mm tief

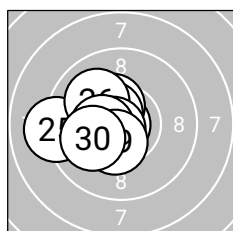

**Serie 3: 102.7** (99)

10.9* ↖	10.4* ↖	10.2* ↖	10.5* ↖	9.1 ↖
10.0 ↖	10.7* ↖	10.4* ↖	10.4* ↓	10.1 ↖

beste Teiler: 23.3 (21.), 66.8 (27.), 105.3 (24.)  
 Trefferkreis: 8.89 mm  
 Trefferlage: 1.39 mm links, 0.02 mm hoch

# ISSF AR Mixed

StandNr: 26

Kreisser, Max #70402039

# Mixed Team

Competition

StartNr: 251

06.02.2026 17:22

SG\_Bad-Häring

Bad-Häring 2

Ergebnis: **309.9** (297)  
 Serien: 102.3 103.2 104.4  
 Zähler: 27 3 0 0 0 0 0 0 0 0  
 Innenzehner: 23  
 Weitestе: 333 (16.), 331 (3.), 313 (23.)  
 beste Teiler: 35.3 (25.), 55.7 (26.), 63.2 (17.)  
 Trefferkreis: 10.67 mm  
 Trefferlage: 0.08 mm rechts, 0.09 mm tief

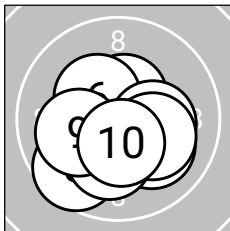
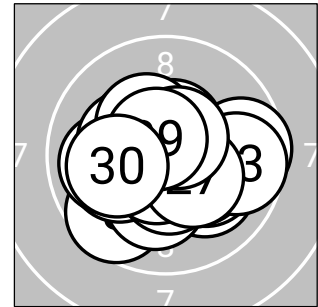

### Serie 1: 102.3 (99)

10.5*↗	10.6*↘	9.6↙	10.1↘	10.2*↘
10.3*↖	10.2*↗	10.2*↘	10.1↖	10.5*↘

beste Teiler: 77.0 (2.), 113.0 (1.), 124.9 (10.)  
 Trefferkreis: 9.09 mm  
 Trefferlage: 0.06 mm rechts, 0.71 mm tief

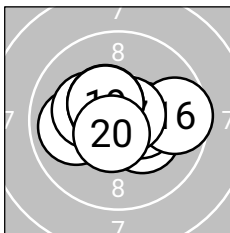

### Serie 2: 103.2 (99)

10.0↖	10.3*↘	10.2*↖	10.4*↗	10.5*↖
9.6↗	10.7*↗	10.4*↖	10.5*↖	10.6*↙

beste Teiler: 63.2 (17.), 87.6 (20.), 104.1 (15.)  
 Trefferkreis: 10.34 mm  
 Trefferlage: 0.02 mm links, 0.20 mm hoch

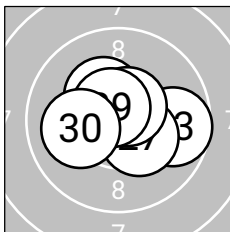

### Serie 3: 104.4 (99)

10.6*↗	10.3*↖	9.7↗	10.7*↗	10.8*↗
10.7*↖	10.3*↘	10.6*↗	10.6*↖	10.1↖

beste Teiler: 35.3 (25.), 55.7 (26.), 64.4 (24.)  
 Trefferkreis: 9.76 mm  
 Trefferlage: 0.21 mm rechts, 0.21 mm hoch



# ISSF AR Mixed

StandNr: 15

Achleitner, Brigitte #70412120

# Mixed Team

Competition

StartNr: 268

06.02.2026 18:15

SG\_Kundl

Kundl 3

Ergebnis: **312.1** (295)  
 Serien: 105.0 102.2 104.9  
 Zähler: 26 3 1 0 0 0 0 0 0 0  
 Innenezehner: 25  
 Weitestе: 559 (14.), 370 (19.), 283 (17.)  
 beste Teiler: 17.0 (18.), 38.3 (30.), 45.8 (7.)  
 Trefferkreis: 13.47 mm  
 Trefferlage: 0.12 mm links, 0.08 mm hoch

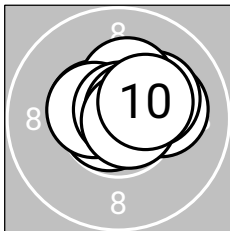
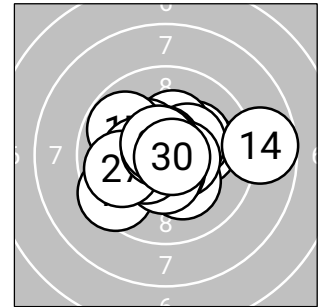

### Serie 1: 105.0 (100)

10.5*↖	10.1→	10.2*↗	10.8*↖	10.3*↗
10.5*↖	10.8*↗	10.6*↗	10.8*→	10.4*↗

beste Teiler: 45.8 (7.), 47.4 (4.), 50.6 (9.)  
 Trefferkreis: 7.62 mm  
 Trefferlage: 0.39 mm rechts, 0.52 mm hoch

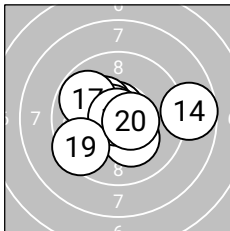

### Serie 2: 102.2 (96)

10.7*↖	10.3*↖	10.8*↓	8.7→	10.7*↖
10.2*↘	9.8↖	10.9*↖	9.5↖	10.6*→

beste Teiler: 17.0 (18.), 50.5 (13.), 68.9 (11.)  
 Trefferkreis: 13.47 mm  
 Trefferlage: 0.01 mm links, 0.00 mm

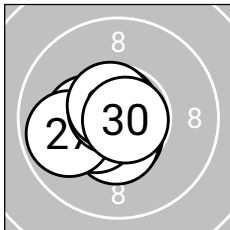

### Serie 3: 104.9 (99)

10.3*↖	10.6*↓	10.5*↓	10.4*↖	10.3*↖
10.8*↗	9.9↖	10.7*↖	10.6*↖	10.8*→

beste Teiler: 38.3 (30.), 46.8 (26.), 55.8 (28.)  
 Trefferkreis: 7.53 mm  
 Trefferlage: 0.76 mm links, 0.26 mm tief



Ergebnis: **309.9** (296)  
 Serien: 103.6 103.0 103.3  
 Zähler: 26 4 0 0 0 0 0 0 0 0  
 Innenzehner: 20  
 Weitester: 308 (12.), 289 (5.), 273 (25.)  
 beste Teiler: 35.3 (24.), 36.7 (8.), 55.2 (6.)  
 Trefferkreis: 10.18 mm  
 Trefferlage: 0.24 mm rechts, 0.35 mm tief

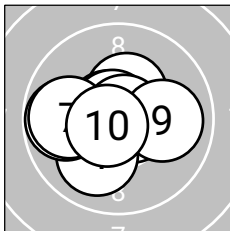
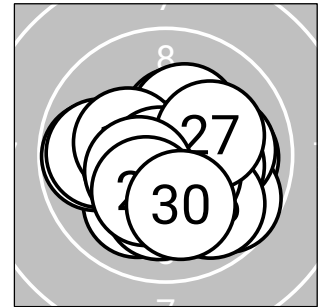

**Serie 1: 103.6** (98)

10.6*➡	10.4*⬆	10.7*⬅	10.0⬇	9.8⬅
10.7*⬅	9.9⬅	10.8*➡	10.0➡	10.7*⬅

beste Teiler: 36.7 (8.), 55.2 (6.), 70.0 (3.)  
 Trefferkreis: 9.81 mm  
 Trefferlage: 0.43 mm links, 0.01 mm tief

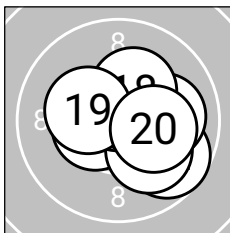

**Serie 2: 103.0** (99)

10.6*➡	9.7➡	10.5*⬅	10.1➡	10.7*⬆
10.0➡	10.6*⬆	10.3*⬆	10.3*⬅	10.2*➡

beste Teiler: 68.1 (15.), 77.3 (11.), 91.3 (17.)  
 Trefferkreis: 9.20 mm  
 Trefferlage: 0.75 mm rechts, 0.06 mm tief

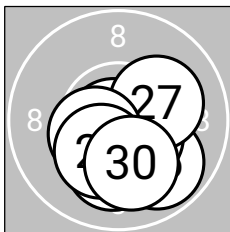

**Serie 3: 103.3** (99)

10.6*⬇	10.1⬇	10.4*➡	10.8*⬇	9.9➡
10.5*➡	10.2*➡	10.4*⬅	10.3*⬇	10.1⬇

beste Teiler: 35.3 (24.), 87.0 (21.), 116.8 (26.)  
 Trefferkreis: 8.13 mm  
 Trefferlage: 0.42 mm rechts, 0.99 mm tief

Ergebnis: **314.9** (299)  
 Serien: 104.4 105.0 105.5  
 Zähler: 29 1 0 0 0 0 0 0 0 0  
 Innenzehner: 26  
 Weitest: 274 (19.), 243 (26.), 227 (20.)  
 beste Teiler: 13.0 (7.), 20.5 (29.), 31.5 (11.)  
 Trefferkreis: 9.33 mm  
 Trefferlage: 0.01 mm rechts, 0.19 mm tief

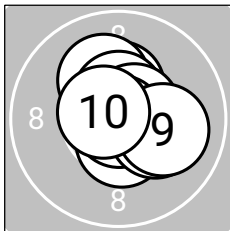
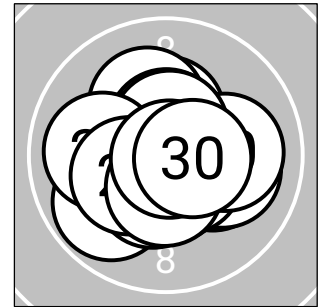

**Serie 1: 104.4** (100)

10.3*↑	10.2*↖	10.5*↑	10.5*↘	10.6*↗
10.5*↓	10.9*↘	10.2*↗	10.1→	10.6*↖

beste Teiler: 13.0 (7.), 79.2 (10.), 88.6 (5.)  
 Trefferkreis: 8.26 mm  
 Trefferlage: 0.44 mm rechts, 0.22 mm hoch

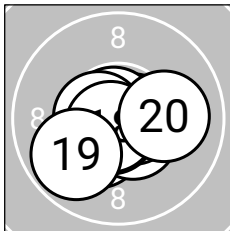

**Serie 2: 105.0** (99)

10.8*→	10.3*↙	10.5*↘	10.7*→	10.7*↙
10.8*↖	10.6*←	10.7*↙	9.9↙	10.0→

beste Teiler: 31.5 (11.), 38.4 (16.), 55.9 (18.)  
 Trefferkreis: 9.25 mm  
 Trefferlage: 0.09 mm links, 0.42 mm tief

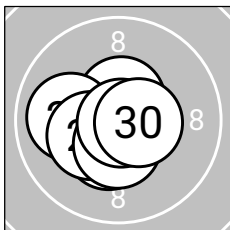

**Serie 3: 105.5** (100)

10.4*↙	10.7*↙	10.6*↑	10.8*↓	10.8*↘
10.0←	10.3*↙	10.5*↓	10.9*↘	10.5*→

beste Teiler: 20.5 (29.), 40.3 (25.), 47.8 (24.)  
 Trefferkreis: 7.97 mm  
 Trefferlage: 0.29 mm links, 0.38 mm tief





**ISSF AR Mixed**

StandNr: 20

**Patka, Walter** #70407014**Mixed Team**

Competition

**StartNr: 273**

06.02.2026 18:15

SG\_Ebbser\_Schützen

Ebbser Schützen 2

Ergebnis: **303.9** (289)  
 Serien: 100.0 102.0 101.9  
 Zähler: 19 11 0 0 0 0 0 0 0 0  
 Innenezehner: 17  
 Weitester: 403 (8.), 383 (26.), 382 (5.)  
 beste Teiler: 21.9 (24.), 29.1 (21.), 69.3 (4.)  
 Trefferkreis: 11.01 mm  
 Trefferlage: 0.76 mm rechts, 0.58 mm tief

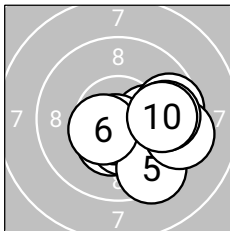
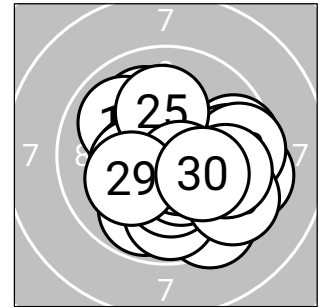
**Serie 1: 100.0** (95)

10.4*↓	10.4*↓	10.2*→	10.7*↓	9.4↘
10.5*↙	9.6→	9.3→	9.7→	9.8→

beste Teiler: 69.3 (4.), 117.6 (6.), 142.8 (2.)  
 Trefferkreis: 9.39 mm  
 Trefferlage: 1.58 mm rechts, 0.73 mm tief

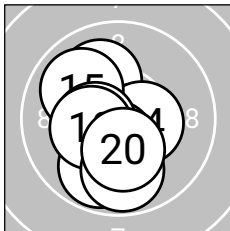
**Serie 2: 102.0** (97)

10.1↑	10.6*↘	9.8↓	10.4*→	9.9↖
10.4*↓	10.4*←	10.3*←	9.8↓	10.3*↓

beste Teiler: 87.2 (12.), 128.6 (16.), 129.2 (17.)  
 Trefferkreis: 9.45 mm  
 Trefferlage: 0.44 mm links, 0.61 mm tief

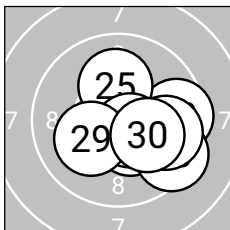
**Serie 3: 101.9** (97)

10.8*↗	9.5→	10.4*↘	10.9*↗	10.1↑
9.4↘	10.6*↘	9.8→	10.2*↙	10.2*↘

beste Teiler: 21.9 (24.), 29.1 (21.), 94.2 (27.)  
 Trefferkreis: 10.03 mm  
 Trefferlage: 1.14 mm rechts, 0.39 mm tief

# ISSF AR Mixed

StandNr: 21

Fercher, Friederike #70401086

# Mixed Team

Competition

StartNr: 274

06.02.2026 18:19

SG\_Angerberg

SG Angerberg 2

Ergebnis: **302.8** (288)  
 Serien: 99.5 99.8 103.5  
 Zähler: 19 10 1 0 0 0 0 0 0 0  
 Innenzehner: 16  
 Weitestе: 569 (7.), 413 (3.), 405 (12.)  
 beste Teiler: 23.6 (28.), 30.8 (23.), 31.8 (14.)  
 Trefferkreis: 14.19 mm  
 Trefferlage: 0.32 mm rechts, 0.43 mm tief

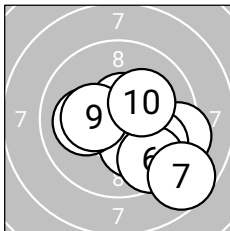
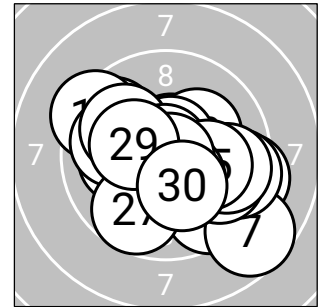

### Serie 1: 99.5 (95)

10.7* ↗	10.6* ↗	9.3 ➡	9.8 ➡	10.2* ↘
9.6 ↘	8.7 ↘	10.1 ←	10.3* ←	10.2* ↗

beste Teiler: 64.2 (1.), 86.0 (2.), 160.2 (9.)  
 Trefferkreis: 11.82 mm  
 Trefferlage: 1.20 mm rechts, 0.85 mm tief

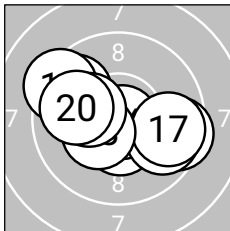

### Serie 2: 99.8 (94)

9.7 ↖	9.3 ↖	10.5* ↓	10.8* ↘	9.5 ➡
9.8 ➡	9.7 ➡	10.4* ↖	10.2* ←	9.9 ↖

beste Teiler: 31.8 (14.), 122.5 (13.), 147.2 (18.)  
 Trefferkreis: 12.16 mm  
 Trefferlage: 0.20 mm links, 0.01 mm tief

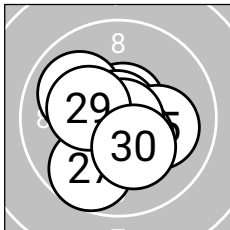

### Serie 3: 103.5 (99)

10.7* ↗	10.0 ↖	10.8* ↗	10.3* ↘	10.1 ➡
10.4* ↘	9.7 ↘	10.9* ↘	10.3* ←	10.3* ↘

beste Teiler: 23.6 (28.), 30.8 (23.), 74.0 (21.)  
 Trefferkreis: 9.45 mm  
 Trefferlage: 0.02 mm links, 0.43 mm tief



# ISSF AR Mixed

StandNr: 22

Fercher, Richard #70401095

# Mixed Team

Competition

StartNr: 275

06.02.2026 18:20

SG\_Angerberg

SG Angerberg 2

Ergebnis: **297.0** (283)  
 Serien: 95.7 101.3 100.0  
 Zähler: 15 14 0 1 0 0 0 0 0 0  
 Innenezehner: 10  
 Weitestе: 814 (4.), 420 (2.), 416 (6.)  
 beste Teiler: 37.3 (13.), 41.1 (11.), 45.8 (20.)  
 Trefferkreis: 16.58 mm  
 Trefferlage: 0.02 mm links, 0.48 mm hoch

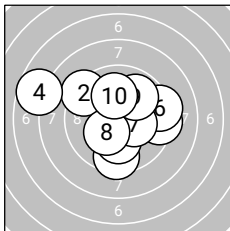
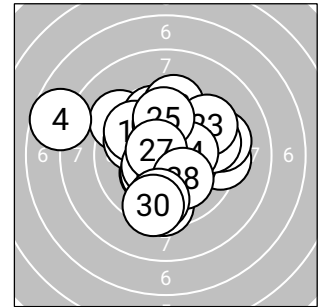

**Serie 1: 95.7** (92)  
 9.5↓                    9.3↖                    10.1↓                    7.7↖                    9.3→  
 9.3→                    10.3\*↗                    10.3\*↖                    9.9↗                    10.0↑  
 beste Teiler: 161.0 (7.), 172.9 (8.), 213.0 (3.)  
 Trefferkreis: 16.58 mm  
 Trefferlage: 0.15 mm links, 0.26 mm hoch

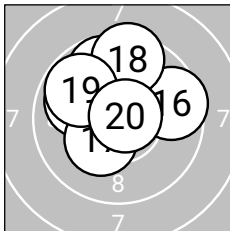

**Serie 2: 101.3** (95)  
 10.8\*↗                    10.0↑                    10.8\*↑                    9.9↖                    9.8↑  
 9.6→                    10.3\*↖                    9.5↑                    9.8↖                    10.8\*→  
 beste Teiler: 37.3 (13.), 41.1 (11.), 45.8 (20.)  
 Trefferkreis: 10.14 mm  
 Trefferlage: 0.30 mm links, 1.21 mm hoch

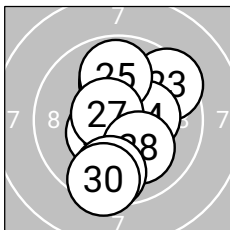

**Serie 3: 100.0** (96)  
 10.2\*↗                    10.0↑                    9.5↗                    10.3\*→                    9.9↑  
 10.4\*↖                    10.6\*↖                    10.1↓                    9.6↓                    9.4↓  
 beste Teiler: 77.8 (27.), 126.8 (26.), 161.3 (24.)  
 Trefferkreis: 11.57 mm  
 Trefferlage: 0.37 mm rechts, 0.03 mm tief



# ISSF AR Mixed

StandNr: 23

Greiderer, Christiane #70406220

# Mixed Team

Competition

StartNr: 276

06.02.2026 18:16

SG\_Bruckhäusl

SG Bruckhäusl 2

Ergebnis: **310.3** (294)  
 Serien: 103.4 103.5 103.4  
 Zähler: 24 6 0 0 0 0 0 0 0 0 0  
 Innenzehner: 23  
 Weitester: 375 (11.), 366 (7.), 318 (24.)  
 beste Teiler: 30.0 (18.), 31.9 (29.), 34.1 (1.)  
 Trefferkreis: 11.33 mm  
 Trefferlage: 0.06 mm rechts, 0.39 mm hoch

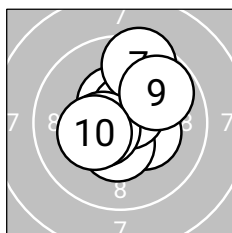
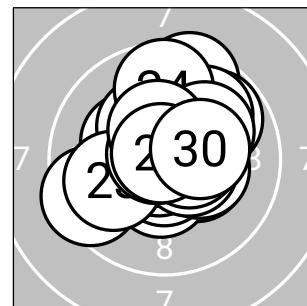

### Serie 1: 103.4 (98)

10.8*➔	10.7*⬅	10.3*➔	10.5*⬆	10.4*⬇
10.6*↗	9.5↗	10.5*⬅	9.8↗	10.3*⬅

beste Teiler: 34.1 (1.), 61.8 (2.), 81.8 (6.)  
 Trefferkreis: 9.48 mm  
 Trefferlage: 0.18 mm rechts, 0.45 mm hoch

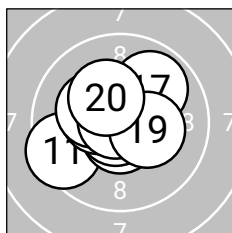

### Serie 2: 103.5 (98)

9.5⬅	10.6*➔	10.6*⬇	10.8*⬆	10.4*⬅
10.3*⬅	9.9↗	10.8*⬅	10.3*➔	10.3*⬆

beste Teiler: 30.0 (18.), 41.8 (14.), 77.0 (13.)  
 Trefferkreis: 10.78 mm  
 Trefferlage: 0.35 mm links, 0.14 mm hoch

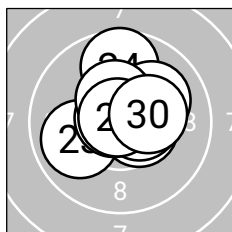

### Serie 3: 103.4 (98)

10.5*➔	10.4*➔	9.9⬅	9.7↑	10.1↗
10.8*⬆	10.5*➔	10.4*⬆	10.8*⬆	10.3*➔

beste Teiler: 31.9 (29.), 45.7 (26.), 111.0 (27.)  
 Trefferkreis: 9.42 mm  
 Trefferlage: 0.36 mm rechts, 0.56 mm hoch

# ISSF AR Mixed Final

StandNr: E

**Greiderer, Christiane** #70406220

# Mixed Team

Medal Match

**StartNr: 276**

06.02.2026 19:17

SG\_Bruckhäusl

SG Bruckhäusl 2

Ergebnis: **113.5** (107)  
Serien: 51.4 51.5 10.6  
Zähler: 8 3 0 0 0 0 0 0 0 0  
Innenzehner: 7  
Weiteste: 295 (5.), 271 (10.), 264 (3.)  
beste Teiler: 23.0 (4.), 78.2 (9.), 93.2 (11.)  
Trefferkreis: 8.57 mm  
Trefferlage: 0.16 mm rechts, 0.79 mm tief

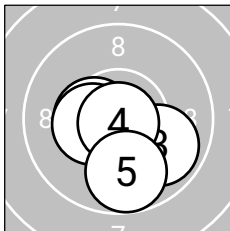
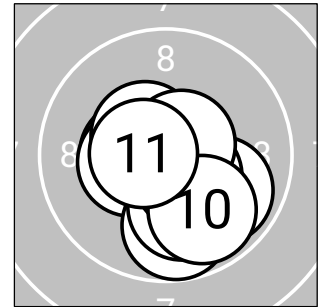

### Serie 1: 51.4 (48)

10.4\*←

10.4\*←

9.9↘

10.9\*↓

9.8↓

beste Teiler: 23.0 (4.), 133.0 (1.), 144.9 (2.)

Trefferkreis: 8.39 mm

Trefferlage: 0.02 mm links, 0.97 mm tief

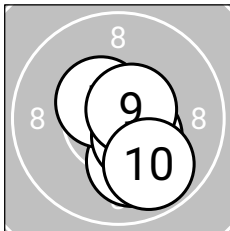

### Serie 2: 51.5 (49)

10.1↓

10.5\*↖

10.4\*↘

10.6\*↗

9.9↘

beste Teiler: 78.2 (9.), 118.1 (7.), 127.3 (8.)

Trefferkreis: 8.38 mm

Trefferlage: 0.57 mm rechts, 0.79 mm tief

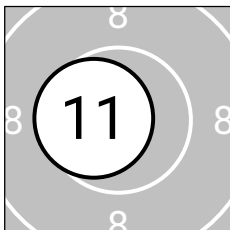

### Serie 3: 10.6 (10)

10.6\*←

beste Teiler: 93.2 (11.)

Trefferkreis: 4.50 mm

Trefferlage: 0.93 mm links, 0.07 mm hoch

Ergebnis: **304.6** (293)  
 Serien: 102.4 98.7 103.5  
 Zähler: 24 5 1 0 0 0 0 0 0 0  
 Innenezehner: 17  
 Weitestе: 624 (20.), 391 (4.), 376 (9.)  
 beste Teiler: 31.0 (10.), 39.8 (3.), 42.8 (7.)  
 Trefferkreis: 13.92 mm  
 Trefferlage: 0.65 mm links, 0.50 mm hoch

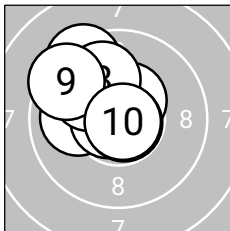
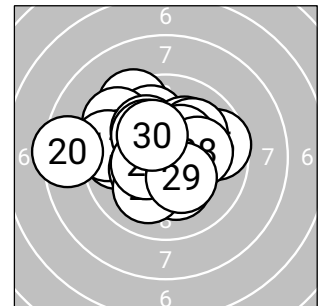

**Serie 1: 102.4** (98)

10.0 ←	10.7* ←	10.8* ↑	9.4 ↘	10.0 ↙
10.5* ↗	10.8* ↘	10.0 ↘	9.4 ↘	10.8* ↘

beste Teiler: 31.0 (10.), 39.8 (3.), 42.8 (7.)  
 Trefferkreis: 8.84 mm  
 Trefferlage: 0.94 mm links, 1.04 mm hoch

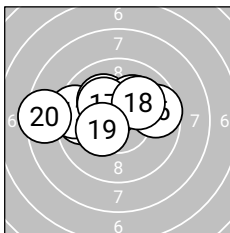

**Serie 2: 98.7** (95)

9.7 ←	9.5 ←	10.1 ↘	10.5* ↘	10.2* ↗
9.6 →	10.2* ↘	10.1 ↗	10.3* ↘	8.5 ←

beste Teiler: 106.8 (14.), 155.3 (19.), 185.6 (17.)  
 Trefferkreis: 13.92 mm  
 Trefferlage: 1.12 mm links, 0.84 mm hoch

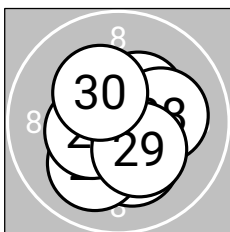

**Serie 3: 103.5** (100)

10.2* ↘	10.4* ↘	10.8* ↘	10.1 ↘	10.4* ←
10.4* ↗	10.5* ↘	10.1 →	10.3* ↘	10.3* ↘

beste Teiler: 48.8 (23.), 105.1 (27.), 129.5 (22.)  
 Trefferkreis: 8.51 mm  
 Trefferlage: 0.11 mm rechts, 0.36 mm tief



Ergebnis: **292.4** (276)  
 Serien: 97.4 98.2 96.8  
 Zähler: 14 9 6 1 0 0 0 0 0 0  
 Innenezehner: 10  
 Weitest: 770 (15.), 614 (1.), 605 (10.)  
 beste Teiler: 49.3 (17.), 51.9 (19.), 60.8 (2.)  
 Trefferkreis: 16.34 mm  
 Trefferlage: 1.20 mm links, 0.45 mm hoch

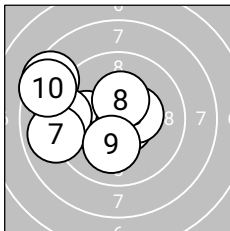
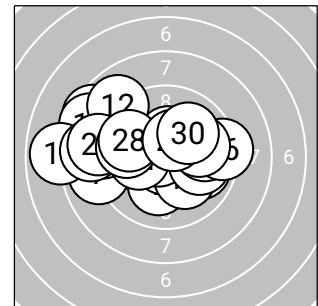

**Serie 1: 97.4** (93)

8.5 ↙      10.7\* →      10.0 ←      9.2 ←      10.7\* ↘  
 10.4\* →      8.9 ←      10.4\* ↑      10.1 ↓      8.5 ↙  
 beste Teiler: 60.8 (2.), 65.7 (5.), 135.3 (6.)  
 Trefferkreis: 11.75 mm  
 Trefferlage: 2.05 mm links, 0.39 mm hoch

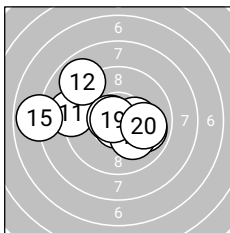

**Serie 2: 98.2** (92)

9.1 ←      8.9 ↙      9.9 →      10.6\* ←      7.9 ←  
 10.3\* →      10.8\* ↓      10.1 ↘      10.7\* ←      9.9 →  
 beste Teiler: 49.3 (17.), 51.9 (19.), 83.9 (14.)  
 Trefferkreis: 14.75 mm  
 Trefferlage: 0.93 mm links, 0.16 mm hoch

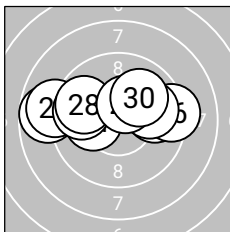

**Serie 3: 96.8** (91)

8.7 ←      9.8 →      8.9 ←      10.2\* ←      9.8 ←  
 9.3 →      9.9 →      9.8 ←      10.4\* ↑      10.0 ↗  
 beste Teiler: 134.7 (29.), 196.4 (24.), 239.1 (30.)  
 Trefferkreis: 14.13 mm  
 Trefferlage: 0.63 mm links, 0.80 mm hoch

# ISSF AR Mixed

StandNr: 24

Fuchs, Andreas #70406019

# Mixed Team

Competition

StartNr: 281

06.02.2026 18:10

SG\_Bruckhäusl

SG Bruckhäusl 2

Ergebnis: **313.3** (298)  
 Serien: 103.1 104.8 105.4  
 Zähler: 28 2 0 0 0 0 0 0 0 0  
 Innenzehner: 25  
 Weitest: 280 (4.), 270 (5.), 214 (10.)  
 beste Teiler: 27.6 (23.), 35.1 (3.), 45.1 (2.)  
 Trefferkreis: 9.41 mm  
 Trefferlage: 0.02 mm rechts, 0.19 mm tief

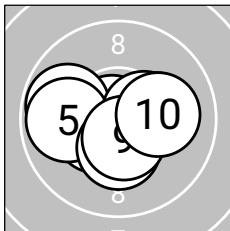
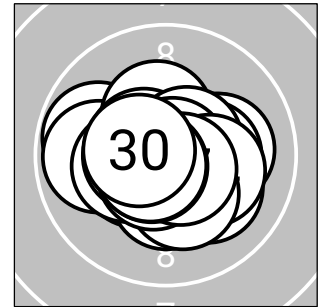

### Serie 1: 103.1 (98)

10.4*↙	10.8*↙	10.8*↙	9.8↙	9.9↙
10.1→	10.3*↓	10.4*→	10.5*↓	10.1→

beste Teiler: 35.1 (3.), 45.1 (2.), 107.2 (9.)  
 Trefferkreis: 9.37 mm  
 Trefferlage: 0.14 mm links, 0.19 mm tief

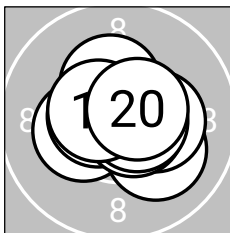

### Serie 2: 104.8 (100)

10.3*↙	10.6*↙	10.7*↗	10.1↘	10.3*→
10.3*↑	10.7*↘	10.6*→	10.6*↙	10.6*↗

beste Teiler: 66.8 (13.), 72.1 (17.), 83.0 (18.)  
 Trefferkreis: 8.11 mm  
 Trefferlage: 0.24 mm rechts, 0.10 mm hoch

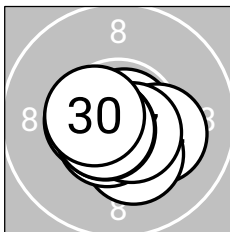

### Serie 3: 105.4 (100)

10.5*↙	10.5*↘	10.8*→	10.2*↘	10.3*↘
10.6*↙	10.6*↘	10.7*↙	10.7*↙	10.5*↙

beste Teiler: 27.6 (23.), 72.6 (28.), 74.8 (29.)  
 Trefferkreis: 7.43 mm  
 Trefferlage: 0.01 mm links, 0.50 mm tief

# ISSF AR Mixed Final

StandNr: F

Fuchs, Andreas #70406019

# Mixed Team

Medal Match

StartNr: 281

06.02.2026 19:17

SG\_Bruckhäusl

SG Bruckhäusl 2

Ergebnis: **113.7** (109)  
Serien: 51.4 51.9 10.4  
Zähler: 10 1 0 0 0 0 0 0 0 0  
Innenzehner: 8  
Weiteste: 322 (6.), 217 (4.), 203 (3.)  
beste Teiler: 45.3 (10.), 57.2 (7.), 134.9 (5.)  
Trefferkreis: 9.80 mm  
Trefferlage: 0.16 mm links, 0.35 mm tief

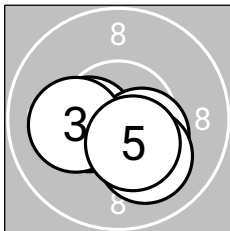
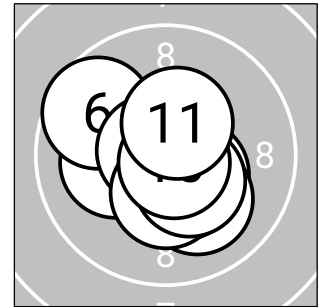

### Serie 1: 51.4 (50)

10.4\*←

10.4\*↘

10.1←

10.1↘

10.4\*↘

beste Teiler: 134.9 (5.), 136.2 (2.), 141.4 (1.)

Trefferkreis: 8.11 mm

Trefferlage: 0.06 mm links, 0.85 mm tief

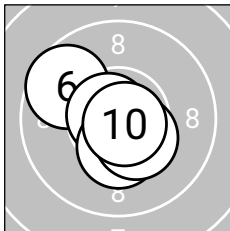

### Serie 2: 51.9 (49)

9.7↙

10.7\*←

10.3\*↓

10.4\*↘

10.8\*↘

beste Teiler: 45.3 (10.), 57.2 (7.), 141.5 (9.)

Trefferkreis: 9.10 mm

Trefferlage: 0.39 mm links, 0.19 mm tief

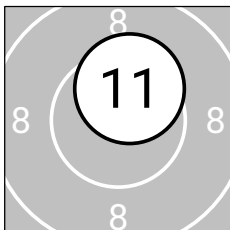

### Serie 3: 10.4 (10)

10.4\*↗

beste Teiler: 136.9 (11.)

Trefferkreis: 4.50 mm

Trefferlage: 0.46 mm rechts, 1.29 mm hoch

Ergebnis: **306.9** (291)  
 Serien: 100.8 103.5 102.6  
 Zähler: 21 9 0 0 0 0 0 0 0 0  
 Innenezehner: 17  
 Weitest: 372 (10.), 357 (30.), 317 (16.)  
 beste Teiler: 6.7 (24.), 8.0 (18.), 21.2 (13.)  
 Trefferkreis: 11.66 mm  
 Trefferlage: 0.94 mm links, 0.33 mm hoch

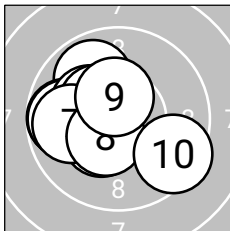
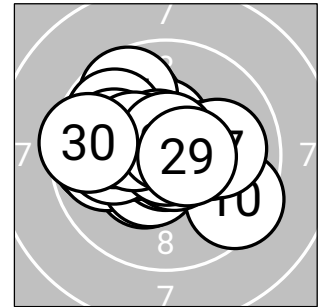

**Serie 1: 100.8** (95)

10.4*↙	9.9↗	9.8←	9.8←	10.2*↖
10.4*↘	9.9←	10.5*↙	10.4*↑	9.5↘

beste Teiler: 124.0 (8.), 127.9 (9.), 144.4 (1.)  
 Trefferkreis: 11.04 mm  
 Trefferlage: 1.16 mm links, 0.09 mm hoch

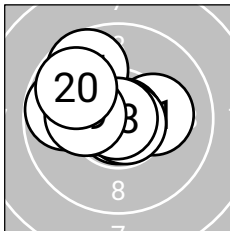

**Serie 2: 103.5** (97)

10.2*→	10.8*↓	10.9*→	10.8*↘	10.4*←
9.7↗	9.8←	10.9*←	10.2*←	9.8↖

beste Teiler: 8.0 (18.), 21.2 (13.), 27.0 (12.)  
 Trefferkreis: 9.36 mm  
 Trefferlage: 0.78 mm links, 0.49 mm hoch

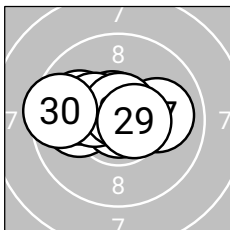

**Serie 3: 102.6** (99)

10.0←	10.6*↗	10.0←	10.9*↘	10.0←
10.3*↖	10.0→	10.7*↑	10.6*→	9.5←

beste Teiler: 6.7 (24.), 62.5 (28.), 80.4 (22.)  
 Trefferkreis: 10.39 mm  
 Trefferlage: 0.88 mm links, 0.42 mm hoch

