

Ergebnis: 401.5 (383)
Serien: 102.2 100.1 100.6 98.6
Zähler: 24 15 1 0 0 0 0 0 0 0
Innenzehner: 17
Weiteste: 511 (20.), 465 (39.), 409 (17.)
beste Teiler: 52.4 (1.), 76.4 (35.), 82.1 (23.)
Trefferkreis: 13.56 mm
Trefferlage: 0.58 mm links, 0.19 mm tief

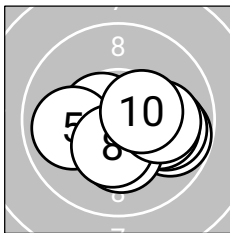
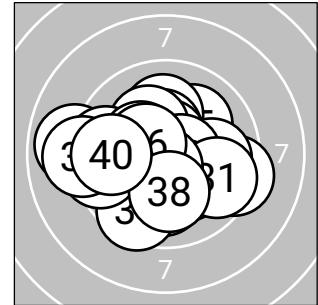

Serie 1: 102.2 (97)

10.7*↙	9.8➔	10.6*↙	9.9➔	9.9↙
10.1➔	10.3*↘	10.4*↘	10.1➔	10.4*➔

beste Teiler: 52.4 (1.), 93.9 (3.), 134.4 (10.)
Trefferkreis: 9.80 mm
Trefferlage: 0.71 mm rechts, 0.50 mm tief

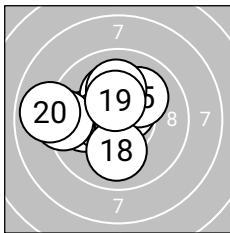

Serie 2: 100.1 (97)

10.0↙	10.2*↗	10.6*↗	10.5*↙	10.1↗
10.1↗	9.3↙	10.0↘	10.4*↗	8.9↙

beste Teiler: 86.6 (13.), 117.0 (14.), 139.9 (19.)
Trefferkreis: 11.23 mm
Trefferlage: 1.19 mm links, 0.56 mm hoch

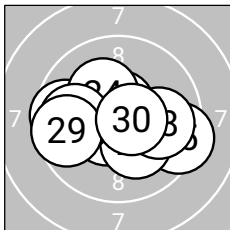

Serie 3: 100.6 (95)

10.6*↙	9.6↙	10.6*↗	10.2*↗	9.4➔
10.2*↘	9.9↙	9.9➔	9.6↙	10.6*➔

beste Teiler: 82.1 (23.), 84.0 (30.), 100.4 (21.)
Trefferkreis: 11.78 mm
Trefferlage: 0.26 mm links, 0.18 mm tief

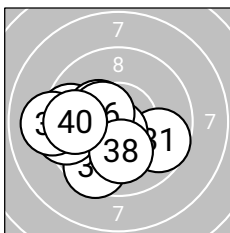

Serie 4: 98.6 (94)

9.7➔	9.6↙	10.3*↙	9.5↘	10.6*↘
10.5*↙	9.5↙	10.1↘	9.1↙	9.7↙

beste Teiler: 76.4 (35.), 124.7 (36.), 156.0 (33.)
Trefferkreis: 12.09 mm
Trefferlage: 1.59 mm links, 0.65 mm tief



Ergebnis: 418.5 (397)
Serien: 104.2 104.2 107.1 103.0
Zähler: 37 3 0 0 0 0 0 0 0 0
Innenzehner: 34
Weiteste: 266 (3.), 266 (35.), 251 (33.)
beste Teiler: 21.9 (28.), 23.4 (23.), 33.5 (25.)
Trefferkreis: 9.47 mm
Trefferlage: 0.06 mm links, 0.22 mm hoch

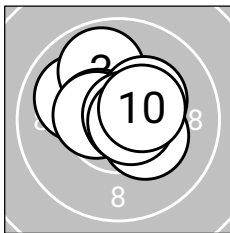
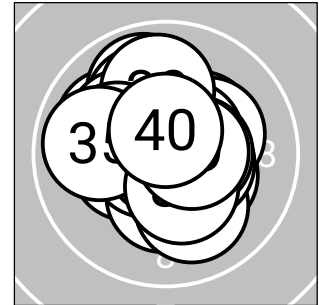

Serie 1: 104.2 (99)

10.0 ↘	10.3* ↘	9.9 ↑	10.5* ←	10.5* ←
10.8* →	10.3* →	10.8* →	10.7* →	10.4* →

beste Teiler: 46.3 (8.), 49.2 (6.), 66.4 (9.)
Trefferkreis: 8.65 mm
Trefferlage: 0.03 mm rechts, 0.52 mm hoch

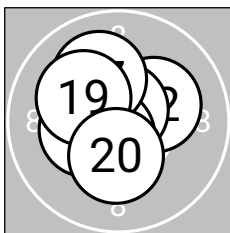

Serie 2: 104.2 (100)

10.4* ↘	10.2* →	10.7* ↘	10.7* ←	10.7* ↑
10.6* ↘	10.1 ↑	10.3* ←	10.2* ↘	10.3* ↓

beste Teiler: 56.2 (15.), 59.7 (14.), 64.0 (13.)
Trefferkreis: 8.32 mm
Trefferlage: 0.46 mm links, 0.26 mm hoch

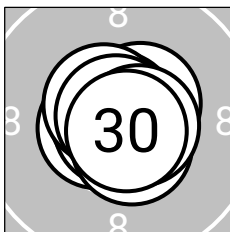

Serie 3: 107.1 (100)

10.6* ↘	10.8* ↘	10.9* ↘	10.5* →	10.8* ↑
10.6* ↘	10.6* ↘	10.9* ↘	10.6* →	10.8* ↘

beste Teiler: 21.9 (28.), 23.4 (23.), 33.5 (25.)
Trefferkreis: 6.38 mm
Trefferlage: 0.04 mm rechts, 0.01 mm hoch

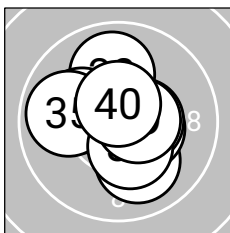

Serie 4: 103.0 (98)

10.0 ↘	10.4* →	9.9 ↑	10.2* ←	9.9 ←
10.6* →	10.5* →	10.4* ↘	10.5* →	10.6* ↑

beste Teiler: 79.1 (36.), 94.0 (40.), 104.2 (39.)
Trefferkreis: 9.38 mm
Trefferlage: 0.10 mm rechts, 0.08 mm hoch



LG 40 ZR

StandNr: 4

Oberhofer, Ramona #70406023

Frauen

Wertung

StartNr: 35

07.02.2026 11:12

SG_Bruckhäusl

Ergebnis: **409.2 (390)**
 Serien: 102.0 101.2 104.2 101.8
 Zähler: 30 10 0 0 0 0 0 0 0 0
 Innenzehner: 20
 Weitester: 428 (5.), 373 (8.), 321 (37.)
 beste Teiler: 35.4 (7.), 46.0 (21.), 46.6 (26.)
 Trefferkreis: 11.82 mm
 Trefferlage: 0.71 mm rechts, 0.18 mm hoch

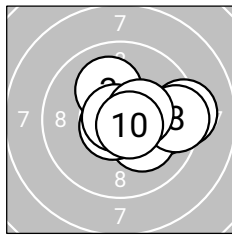
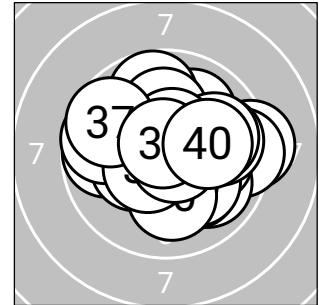
**Serie 1: 102.0 (97)**

10.6*↗ 9.8→ 10.1↖ 10.2*↘ 9.2→
 10.7*↙ 10.8*↖ 9.5→ 10.4*→ 10.7*↘

beste Teiler: 35.4 (7.), 67.3 (6.), 71.1 (10.)
 Trefferkreis: 9.78 mm
 Trefferlage: 1.33 mm rechts, 0.15 mm hoch

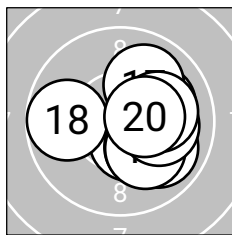
**Serie 2: 101.2 (98)**

10.5*↘ 9.9↘ 10.2*↘ 10.1↘ 10.1→
 10.1→ 10.0↗ 9.8← 10.1→ 10.4*→

beste Teiler: 119.8 (11.), 138.4 (20.), 197.3 (13.)
 Trefferkreis: 9.91 mm
 Trefferlage: 1.13 mm rechts, 0.18 mm tief

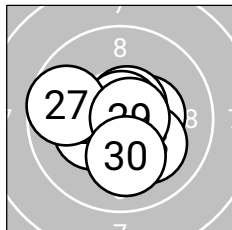
**Serie 3: 104.2 (99)**

10.8*↗ 10.3*↖ 10.4*→ 10.7*→ 10.6*↗
 10.8*↗ 9.7← 10.1↘ 10.7*→ 10.1↓

beste Teiler: 46.0 (21.), 46.6 (26.), 53.4 (29.)
 Trefferkreis: 9.55 mm
 Trefferlage: 0.05 mm rechts, 0.17 mm tief

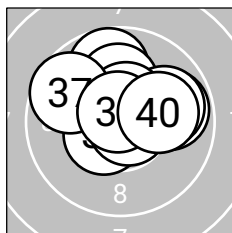
**Serie 4: 101.8 (96)**

9.8→ 10.5*↙ 9.7↑ 10.1↑ 9.9→
 10.5*↗ 9.7↖ 10.8*→ 10.7*↑ 10.1→

beste Teiler: 48.8 (38.), 55.7 (39.), 110.4 (36.)
 Trefferkreis: 10.06 mm
 Trefferlage: 0.33 mm rechts, 0.93 mm hoch

Ergebnis: **411.4 (397)**
Serien: 101.7 104.9 103.3 101.5
Zähler: 37 3 0 0 0 0 0 0 0 0
Innenzehner: 25
Weiteste: 280 (37.), 279 (38.), 251 (36.)
beste Teiler: 6.0 (11.), 78.4 (16.), 81.3 (34.)
Trefferkreis: 9.60 mm
Trefferlage: 0.29 mm rechts, 0.50 mm hoch

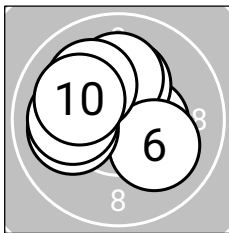
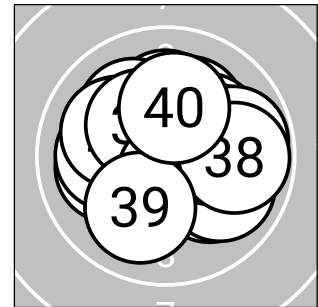

Serie 1: 101.7 (100)

10.4*↑ 10.4*→ 10.1↖ 10.3*↑ 10.1↑
 10.1↘ 10.0← 10.1↖ 10.1← 10.1↖

beste Teiler: 126.0 (2.), 136.1 (1.), 175.5 (4.)
Trefferkreis: 8.90 mm
Trefferlage: 0.57 mm links, 0.73 mm hoch

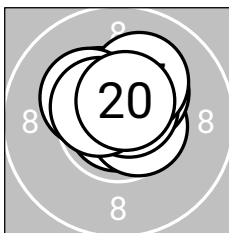

Serie 2: 104.9 (100)

10.9*← 10.6*↗ 10.6*→ 10.4*↖ 10.3*↗
 10.6*↗ 10.1↗ 10.3*↖ 10.5*↖ 10.6*↗

beste Teiler: 6.0 (11.), 78.4 (16.), 92.8 (13.)
Trefferkreis: 7.23 mm
Trefferlage: 0.09 mm rechts, 0.81 mm hoch

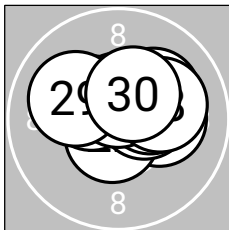

Serie 3: 103.3 (100)

10.2*→ 10.6*↘ 10.4*→ 10.3*→ 10.4*↖
 10.6*↑ 10.2*↗ 10.1→ 10.1↖ 10.4*↗

beste Teiler: 82.2 (22.), 90.0 (26.), 128.5 (23.)
Trefferkreis: 8.58 mm
Trefferlage: 0.54 mm rechts, 0.57 mm hoch

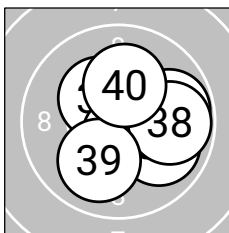

Serie 4: 101.5 (97)

10.3*↖ 10.1→ 10.5*↘ 10.6*↘ 10.3*→
 9.9↘ 9.8→ 9.8→ 10.0↘ 10.2*↑

beste Teiler: 81.3 (34.), 118.4 (33.), 162.2 (31.)
Trefferkreis: 9.23 mm
Trefferlage: 1.11 mm rechts, 0.08 mm tief

Ergebnis: 408.3 (391)
Serien: 104.3 101.0 102.7 100.3
Zähler: 32 7 1 0 0 0 0 0 0 0
Innenzehner: 23
Weiteste: 513 (16.), 473 (40.), 374 (39.)
beste Teiler: 18.4 (1.), 23.4 (9.), 40.0 (28.)
Trefferkreis: 12.76 mm
Trefferlage: 0.31 mm links, 0.67 mm hoch

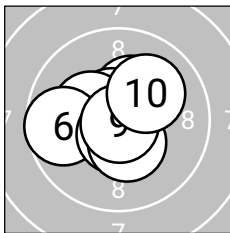
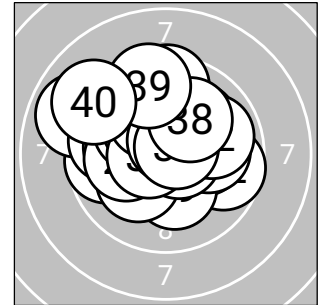

Serie 1: 104.3 (99)

10.9*↘	10.5*↖	10.3*↗	10.6*↖	10.3*↖
9.7↖	10.6*↘	10.4*↘	10.9*↘	10.1↗

beste Teiler: 18.4 (1.), 23.4 (9.), 80.0 (4.)
Trefferkreis: 9.60 mm
Trefferlage: 0.33 mm links, 0.17 mm hoch

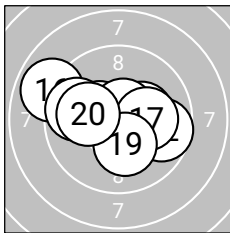

Serie 2: 101.0 (96)

10.4*↖	9.7↗	10.8*↖	10.3*↗	10.7*↗
8.9↖	10.2*↗	9.7↖	10.2*↘	10.1↖

beste Teiler: 43.6 (13.), 73.3 (15.), 141.0 (11.)
Trefferkreis: 12.76 mm
Trefferlage: 0.40 mm links, 0.23 mm hoch

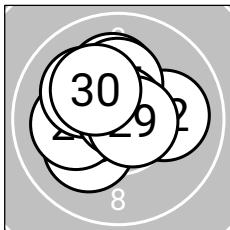

Serie 3: 102.7 (100)

10.3*↖	10.0↗	10.2*↖	10.1↖	10.1↖
10.1↗	10.2*↗	10.8*↗	10.7*↗	10.2*↖

beste Teiler: 40.0 (28.), 72.1 (29.), 155.0 (21.)
Trefferkreis: 8.90 mm
Trefferlage: 0.51 mm links, 0.53 mm hoch

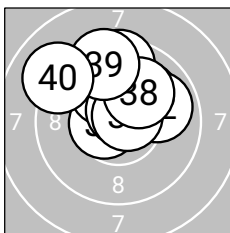

Serie 4: 100.3 (96)

10.1↗	9.9↗	10.6*↖	9.5↗	10.1↖
10.7*↗	10.7*↗	10.1↗	9.5↗	9.1↖

beste Teiler: 69.0 (37.), 75.4 (36.), 89.5 (33.)
Trefferkreis: 11.06 mm
Trefferlage: 0.03 mm links, 1.73 mm hoch



Ergebnis: **421.7 (400)**
 Serien: 105.2 105.0 105.5 106.0
 Zähler: 40 0 0 0 0 0 0 0 0 0 0
 Innenzehner: 39
 Weitester: 219 (16.), 182 (2.), 179 (13.)
 beste Teiler: 14.3 (35.), 26.9 (39.), 34.0 (32.)
 Trefferkreis: 8.18 mm
 Trefferlage: 0.20 mm rechts, 0.03 mm tief

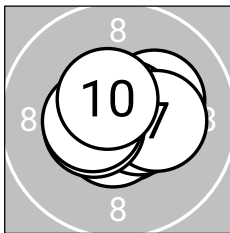
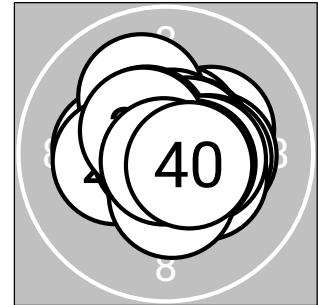

Serie 1: 105.2 (100)

10.6*↗	10.2*↗	10.7*↘	10.6*↘	10.6*↗
10.7*↗	10.3*↗	10.5*↖	10.5*↖	10.5*↖

beste Teiler: 54.4 (6.), 58.5 (3.), 78.4 (4.)
 Trefferkreis: 7.44 mm
 Trefferlage: 0.27 mm rechts, 0.06 mm hoch

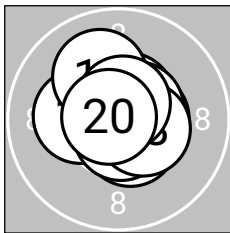

Serie 2: 105.0 (100)

10.5*↗	10.5*↗	10.2*↖	10.5*↘	10.6*↗
10.1↖	10.7*↘	10.5*↗	10.6*↗	10.8*↖

beste Teiler: 45.6 (20.), 66.0 (17.), 79.1 (19.)
 Trefferkreis: 7.81 mm
 Trefferlage: 0.13 mm rechts, 0.24 mm hoch

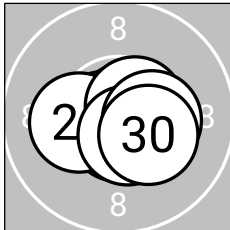

Serie 3: 105.5 (100)

10.8*↖	10.7*↘	10.8*↗	10.7*↖	10.5*↗
10.2*↖	10.6*↗	10.6*↘	10.3*↗	10.3*↗

beste Teiler: 34.1 (23.), 39.8 (21.), 67.0 (22.)
 Trefferkreis: 7.80 mm
 Trefferlage: 0.26 mm rechts, 0.26 mm tief

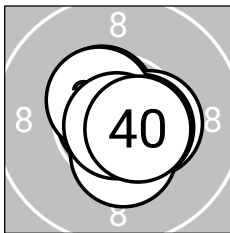

Serie 4: 106.0 (100)

10.5*↘	10.8*↖	10.5*↖	10.4*↗	10.9*↖
10.6*↗	10.4*↘	10.5*↖	10.8*↘	10.6*↗

beste Teiler: 14.3 (35.), 26.9 (39.), 34.0 (32.)
 Trefferkreis: 7.10 mm
 Trefferlage: 0.14 mm rechts, 0.20 mm tief

LG 40 ZR

StandNr: 9

Hintner, Patrick #70403010

Männer

Wertung

StartNr: 18

07.02.2026 11:14

SG_Brandenberg

SG Brandenburg 1

Ergebnis: **405.4 (385)**
 Serien: 102.0 101.2 102.9 99.3
 Zähler: 26 13 1 0 0 0 0 0 0 0
 Innenzehner: 22
 Weitester: 564 (18.), 453 (38.), 392 (40.)
 beste Teiler: 27.7 (35.), 29.0 (30.), 34.9 (8.)
 Trefferkreis: 13.72 mm
 Trefferlage: 0.35 mm links, 0.26 mm tief

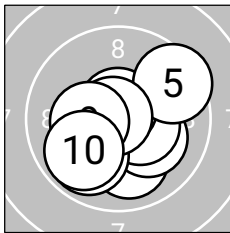
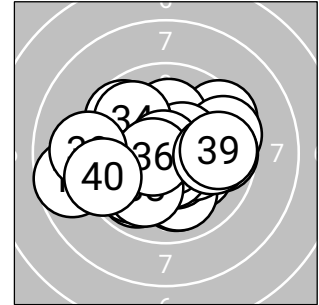
**Serie 1: 102.0 (97)**

10.0↓	10.2*↘	10.4*↘	10.7*↑	9.5↗
9.9↙	10.3*↙	10.8*↙	10.3*←	9.9↙

beste Teiler: 34.9 (8.), 65.0 (4.), 130.3 (3.)
 Trefferkreis: 10.82 mm
 Trefferlage: 0.05 mm links, 0.56 mm tief

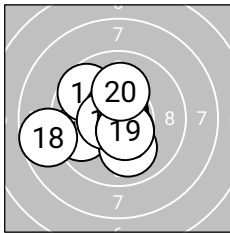
**Serie 2: 101.2 (96)**

9.7↙	10.7*↑	10.7*↑	9.7↖	10.0↓
10.6*↙	10.5*↘	8.7↙	10.5*↘	10.1↑

beste Teiler: 57.2 (12.), 65.4 (13.), 98.0 (16.)
 Trefferkreis: 11.38 mm
 Trefferlage: 0.98 mm links, 0.15 mm tief

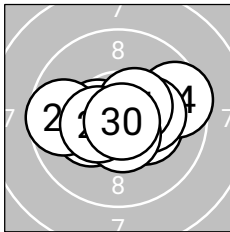
**Serie 3: 102.9 (98)**

10.3*↘	10.3*↙	10.5*←	9.5→	10.2*↘
10.5*↗	9.7↙	10.6*↓	10.5*←	10.8*↘

beste Teiler: 29.0 (30.), 98.4 (28.), 119.4 (26.)
 Trefferkreis: 11.16 mm
 Trefferlage: 0.08 mm rechts, 0.05 mm tief

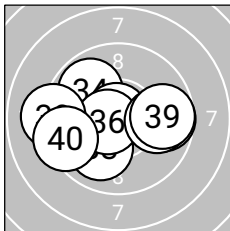
**Serie 4: 99.3 (94)**

9.7→	10.2*↙	10.0↙	9.9↖	10.8*↖
10.6*↙	9.9→	9.1←	9.7→	9.4↙

beste Teiler: 27.7 (35.), 78.1 (36.), 196.3 (32.)
 Trefferkreis: 12.15 mm
 Trefferlage: 0.46 mm links, 0.28 mm tief

Ergebnis: 420.1 (399)
Serien: 104.6 105.2 105.5 104.8
Zähler: 39 1 0 0 0 0 0 0 0 0
Innenzehner: 35
Weiteste: 322 (4.), 246 (26.), 239 (37.)
beste Teiler: 22.3 (15.), 22.8 (21.), 31.0 (18.)
Trefferkreis: 9.52 mm
Trefferlage: 0.36 mm links, 0.06 mm hoch

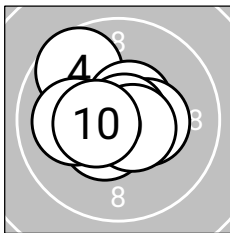
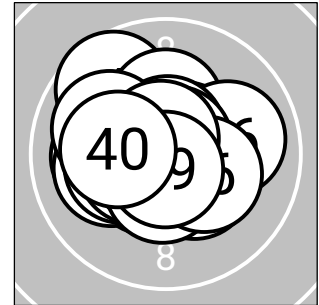

Serie 1: 104.6 (99)

10.7*↗	10.7*↘	10.5*↘	9.7↖	10.1←
10.6*↗	10.4*→	10.8*↗	10.6*↘	10.5*←

beste Teiler: 33.2 (8.), 51.9 (2.), 54.4 (1.)
Trefferkreis: 8.87 mm
Trefferlage: 0.29 mm links, 0.16 mm hoch

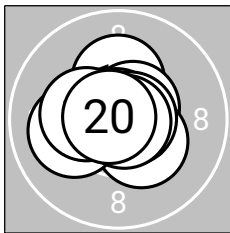

Serie 2: 105.2 (100)

10.2*↑	10.6*↗	10.3*↘	10.5*←	10.9*↖
10.1←	10.7*→	10.8*↘	10.3*←	10.8*←

beste Teiler: 22.3 (15.), 31.0 (18.), 45.6 (20.)
Trefferkreis: 8.16 mm
Trefferlage: 0.26 mm links, 0.14 mm hoch

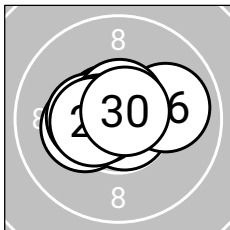

Serie 3: 105.5 (100)

10.9*↘	10.7*↖	10.3*←	10.4*←	10.8*↘
10.0→	10.6*↑	10.6*←	10.5*←	10.7*↗

beste Teiler: 22.8 (21.), 46.6 (25.), 51.7 (30.)
Trefferkreis: 8.71 mm
Trefferlage: 0.28 mm links, 0.12 mm hoch

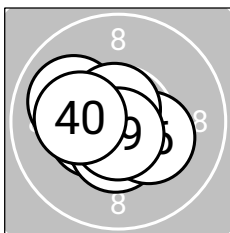

Serie 4: 104.8 (100)

10.4*↘	10.8*↖	10.6*↘	10.6*←	10.5*↓
10.3*↘	10.0←	10.7*↖	10.7*↓	10.2*←

beste Teiler: 49.6 (32.), 60.0 (39.), 62.9 (38.)
Trefferkreis: 8.57 mm
Trefferlage: 0.61 mm links, 0.16 mm tief

Ergebnis: 415.7 (396)
Serien: 105.6 104.1 103.6 102.4
Zähler: 36 4 0 0 0 0 0 0 0 0
Innenzehner: 32
Weiteste: 373 (32.), 347 (35.), 305 (36.)
beste Teiler: 33.8 (12.), 37.1 (1.), 40.8 (7.)
Trefferkreis: 11.35 mm
Trefferlage: 0.09 mm links, 0.37 mm tief

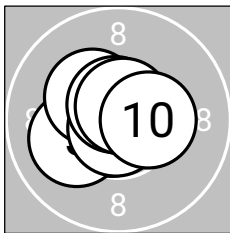
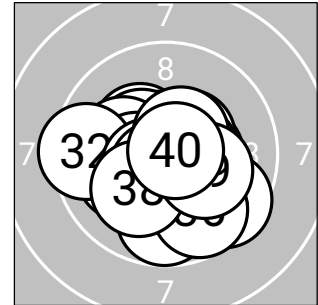

Serie 1: 105.6 (100)

10.8*↗	10.7*↙	10.8*↑	10.3*↖	10.1↖
10.3*↖	10.8*↙	10.7*↑	10.7*↗	10.4*↗

beste Teiler: 37.1 (1.), 40.8 (7.), 47.0 (3.)
Trefferkreis: 7.96 mm
Trefferlage: 0.34 mm links, 0.07 mm hoch

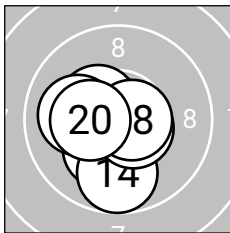

Serie 2: 104.1 (99)

10.7*↙	10.8*↙	10.2*↙	9.8↓	10.6*↗
10.7*↖	10.4*↖	10.6*↗	10.0←	10.3*←

beste Teiler: 33.8 (12.), 52.3 (11.), 64.0 (16.)
Trefferkreis: 8.46 mm
Trefferlage: 0.53 mm links, 0.45 mm tief

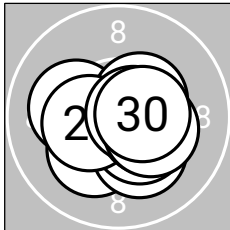

Serie 3: 103.6 (100)

10.1←	10.4*↗	10.2*↙	10.2*↘	10.4*↘
10.4*←	10.4*↗	10.7*↗	10.3*↗	10.5*↗

beste Teiler: 72.3 (28.), 114.8 (30.), 128.4 (22.)
Trefferkreis: 8.18 mm
Trefferlage: 0.33 mm rechts, 0.38 mm tief

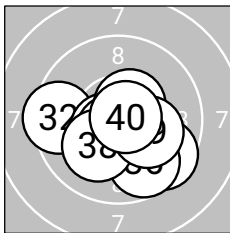

Serie 4: 102.4 (97)

10.8*↗	9.5←	10.6*↙	10.5*↗	9.6↘
9.7↘	10.6*↙	10.1↙	10.2*↗	10.8*↗

beste Teiler: 48.1 (31.), 48.7 (40.), 79.6 (37.)
Trefferkreis: 11.35 mm
Trefferlage: 0.16 mm rechts, 0.74 mm tief



Ergebnis: 395.3 (375)
Serien: 99.7 95.4 101.5 98.7
Zähler: 22 13 3 2 0 0 0 0 0 0
Innenzehner: 16
Weiteste: 976 (31.), 839 (17.), 563 (19.)
beste Teiler: 9.8 (24.), 25.0 (27.), 44.1 (25.)
Trefferkreis: 15.73 mm
Trefferlage: 1.75 mm rechts, 0.91 mm hoch

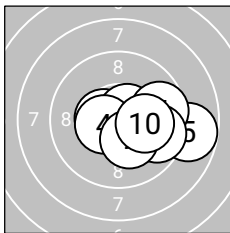
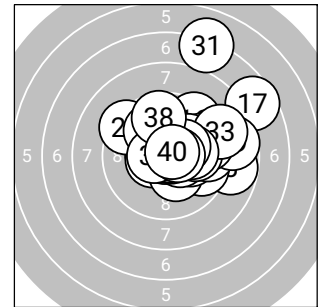

Serie 1: 99.7 (94)

9.7➔	10.5*←	10.6*➔	10.5*←	8.8➔
9.8➔	9.7➔	9.7➔	10.3*↘	10.1➔

beste Teiler: 85.0 (3.), 112.5 (2.), 114.7 (4.)
Trefferkreis: 11.08 mm
Trefferlage: 1.87 mm rechts, 0.26 mm tief

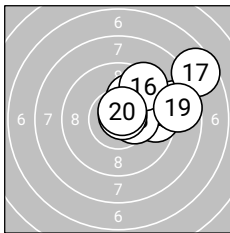

Serie 2: 95.4 (90)

10.0↗	9.6➔	9.7➔	8.8➔	10.3*➔
9.4↗	7.6➔	10.7*↗	8.7➔	10.6*↗

beste Teiler: 54.4 (18.), 84.0 (20.), 152.0 (15.)
Trefferkreis: 12.36 mm
Trefferlage: 2.98 mm rechts, 1.45 mm hoch

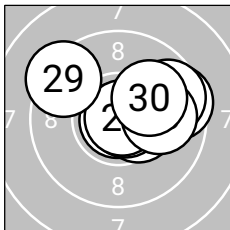

Serie 3: 101.5 (96)

9.8➔	9.5➔	10.5*➔	10.9*←	10.8*➔
9.7➔	10.9*➔	10.0➔	9.3↙	10.1➔

beste Teiler: 9.8 (24.), 25.0 (27.), 44.1 (25.)
Trefferkreis: 11.31 mm
Trefferlage: 1.19 mm rechts, 0.66 mm hoch

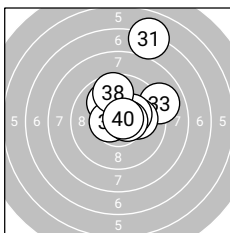

Serie 4: 98.7 (95)

7.0↗	10.0↖	9.0➔	10.1➔	10.7*←
10.3*↗	10.6*←	9.7↗	10.6*➔	10.7*➔

beste Teiler: 62.9 (40.), 68.6 (35.), 97.0 (37.)
Trefferkreis: 14.64 mm
Trefferlage: 0.95 mm rechts, 1.81 mm hoch



Ergebnis: 388.3 (369)
Serien: 96.9 92.0 102.2 97.2
Zähler: 18 19 2 0 0 0 0 0 1 0 0
Innenzehner: 13
Weiteste: 2180 (15.), 649 (32.), 600 (2.)
beste Teiler: 64.0 (24.), 70.0 (14.), 76.2 (25.)
Trefferkreis: 32.66 mm
Trefferlage: 0.39 mm links, 0.12 mm hoch

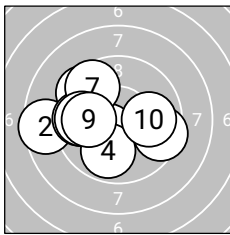
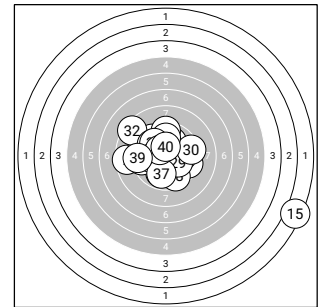

Serie 1: 96.9 (91)

9.5 ↖	8.6 ←	10.4* ↖	9.9 ↘	9.7 ←
9.5 →	9.6 ↗	9.8 ←	10.0 ←	9.9 →

beste Teiler: 126.6 (3.), 242.0 (9.), 252.0 (10.)
Trefferkreis: 13.97 mm
Trefferlage: 1.53 mm links, 0.01 mm tief

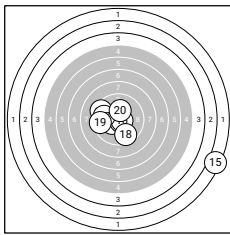

Serie 2: 92.0 (87)

9.7 ←	9.4 ↖	10.3* ↖	10.7* ↘	2.2 ↘
10.6* →	9.8 ←	9.6 ↘	9.5 ←	10.2* ↑

beste Teiler: 70.0 (14.), 79.3 (16.), 156.2 (13.)
Trefferkreis: 30.25 mm
Trefferlage: 0.83 mm rechts, 1.02 mm tief

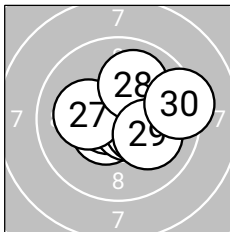

Serie 3: 102.2 (99)

10.1 →	10.5* ↖	10.3* ↗	10.7* ←	10.6* ↘
10.4* →	10.2* ←	10.0 ↗	10.1 →	9.3 →

beste Teiler: 64.0 (24.), 76.2 (25.), 104.2 (22.)
Trefferkreis: 10.38 mm
Trefferlage: 0.84 mm rechts, 0.17 mm hoch

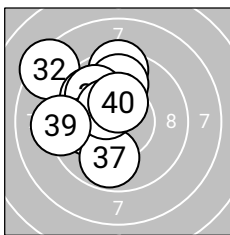

Serie 4: 97.2 (92)

9.4 ↑	8.4 ↖	9.8 ↑	9.8 ↖	9.9 ↖
10.1 ←	9.8 ↘	10.4* ↖	9.2 ←	10.4* ↑

beste Teiler: 130.8 (38.), 143.0 (40.), 216.3 (36.)
Trefferkreis: 12.55 mm
Trefferlage: 1.71 mm links, 1.35 mm hoch



Ergebnis: 364.3 (349)
Serien: 91.0 90.8 96.1 86.4
Zähler: 11 13 13 2 0 0 1 0 0 0 0
Innenzehner: 7
Weiteste: 1503 (31.), 898 (10.), 848 (32.)
beste Teiler: 29.9 (36.), 47.6 (24.), 59.9 (4.)
Trefferkreis: 25.77 mm
Trefferlage: 2.18 mm rechts, 2.25 mm tief

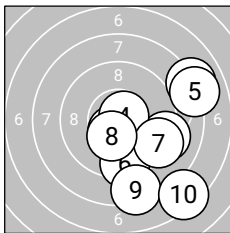
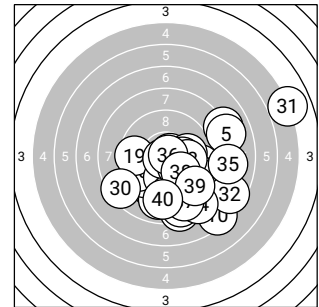

Serie 1: 91.0 (88)

8.0➔ 10.5*⬇ 9.1➔ 10.7*➔ 8.0➔
 9.4⬇ 9.3➔ 10.3*⬇ 8.3⬇ 7.4➔

beste Teiler: 59.9 (4.), 108.6 (2.), 158.3 (8.)
Trefferkreis: 15.39 mm
Trefferlage: 2.88 mm rechts, 1.68 mm tief

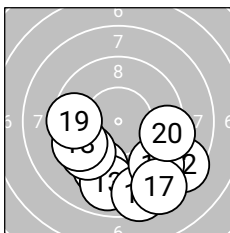

Serie 2: 90.8 (86)

9.4⬇ 8.5➔ 8.9⬇ 8.5⬇ 9.6↙
 9.1➔ 8.5➔ 9.5↙ 9.5↙ 9.3➔

beste Teiler: 350.7 (15.), 358.0 (19.), 360.0 (18.)
Trefferkreis: 13.90 mm
Trefferlage: 0.56 mm rechts, 3.20 mm tief

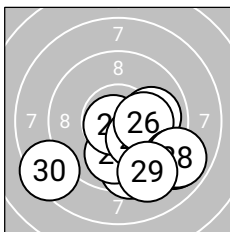

Serie 3: 96.1 (92)

9.5⬇ 10.0➔ 10.0⬇ 10.8*↙ 10.2*➔
 10.2*➔ 8.9➔ 8.9➔ 9.2⬇ 8.4↙

beste Teiler: 47.6 (24.), 184.5 (25.), 190.2 (26.)
Trefferkreis: 14.08 mm
Trefferlage: 1.14 mm rechts, 2.05 mm tief

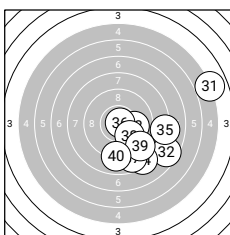

Serie 4: 86.4 (83)

4.9➔ 7.6➔ 10.0➔ 8.3⬇ 8.1➔
 10.8*➔ 8.7⬇ 10.0➔ 9.0⬇ 9.0⬇

beste Teiler: 29.9 (36.), 248.2 (38.), 248.9 (33.)
Trefferkreis: 22.29 mm
Trefferlage: 4.16 mm rechts, 2.05 mm tief



Ergebnis: 413.0 (395)
Serien: 103.5 103.4 103.3 102.8
Zähler: 35 5 0 0 0 0 0 0 0 0
Innenzehner: 30
Weiteste: 378 (34.), 286 (39.), 278 (15.)
beste Teiler: 19.4 (31.), 60.8 (24.), 63.5 (13.)
Trefferkreis: 11.06 mm
Trefferlage: 0.34 mm rechts, 0.08 mm tief

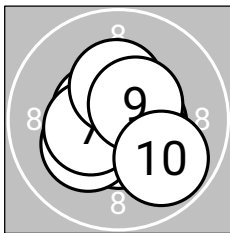
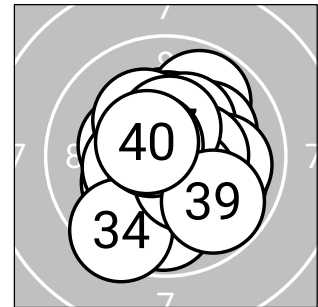

Serie 1: 103.5 (99)

10.5*→ 10.5*↙ 10.6*↖ 10.1↘ 10.5*↓
 10.2*↙ 10.4*↖ 10.3*↑ 10.5*↗ 9.9↘

beste Teiler: 99.8 (3.), 102.0 (5.), 102.2 (1.)
Trefferkreis: 8.67 mm
Trefferlage: 0.10 mm rechts, 0.40 mm tief

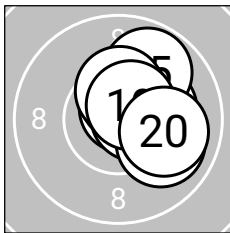

Serie 2: 103.4 (99)

10.2*→ 10.6*↗ 10.7*↗ 10.6*→ 9.8↗
 10.5*↗ 10.4*↑ 10.0↘ 10.6*↗ 10.0→

beste Teiler: 63.5 (13.), 85.8 (12.), 87.2 (14.)
Trefferkreis: 8.10 mm
Trefferlage: 1.01 mm rechts, 0.58 mm hoch

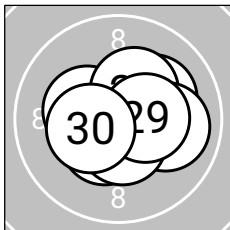

Serie 3: 103.3 (100)

10.2*→ 10.4*↙ 10.1↗ 10.7*↖ 10.3*↖
 10.3*↗ 10.0→ 10.5*↓ 10.4*→ 10.4*↖

beste Teiler: 60.8 (24.), 111.0 (28.), 129.0 (22.)
Trefferkreis: 8.56 mm
Trefferlage: 0.40 mm rechts, 0.07 mm tief

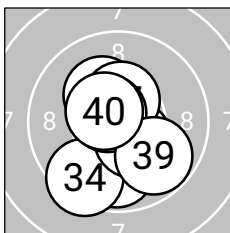

Serie 4: 102.8 (97)

10.9*↓ 9.9↓ 10.6*↑ 9.4↙ 10.4*↘
 10.2*↖ 10.5*↑ 10.6*↖ 9.8↘ 10.5*↖

beste Teiler: 19.4 (31.), 78.4 (38.), 92.3 (33.)
Trefferkreis: 9.82 mm
Trefferlage: 0.14 mm links, 0.43 mm tief



Ergebnis: **421.0** (400)
 Serien: 105.4 106.0 103.9 105.7
 Zähler: 40 0 0 0 0 0 0 0 0 0 0
 Innenzehner: 36
 Weitester: 243 (37.), 237 (22.), 225 (24.)
 beste Teiler: 13.6 (38.), 20.0 (25.), 28.3 (5.)
 Trefferkreis: 8.35 mm
 Trefferlage: 0.24 mm rechts, 0.17 mm tief

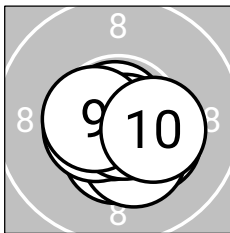
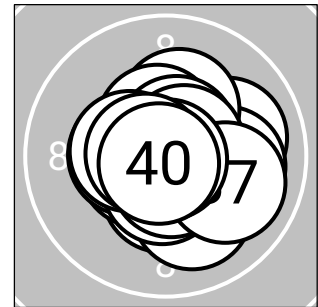

Serie 1: 105.4 (100)

10.7*←	10.3*↘	10.4*↓	10.3*↘	10.8*↖
10.8*↙	10.5*←	10.8*↘	10.5*←	10.3*↘

beste Teiler: 28.3 (5.), 41.0 (8.), 41.2 (6.)
 Trefferkreis: 7.06 mm
 Trefferlage: 0.07 mm rechts, 0.49 mm tief

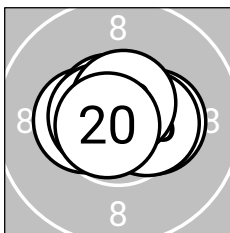

Serie 2: 106.0 (100)

10.8*↗	10.7*↗	10.3*→	10.6*←	10.5*→
10.4*←	10.7*↖	10.6*←	10.6*↑	10.8*←

beste Teiler: 49.9 (20.), 50.4 (11.), 66.0 (12.)
 Trefferkreis: 7.41 mm
 Trefferlage: 0.02 mm links, 0.23 mm hoch

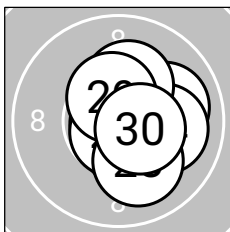

Serie 3: 103.9 (100)

10.5*↘	10.0→	10.4*↘	10.1→	10.9*↖
10.2*↗	10.7*↓	10.1↘	10.5*↑	10.5*↘

beste Teiler: 20.0 (25.), 56.6 (27.), 115.7 (30.)
 Trefferkreis: 8.26 mm
 Trefferlage: 0.76 mm rechts, 0.19 mm tief

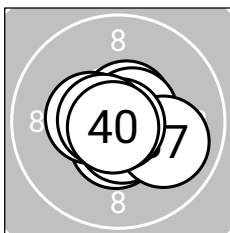

Serie 4: 105.7 (100)

10.5*↓	10.6*↗	10.6*↘	10.4*←	10.6*↗
10.6*↓	10.0→	10.9*↘	10.7*←	10.8*↖

beste Teiler: 13.6 (38.), 38.2 (40.), 75.4 (39.)
 Trefferkreis: 8.25 mm
 Trefferlage: 0.15 mm rechts, 0.24 mm tief



LG 40 ZR

StandNr: 8

Steinberger, Markus #70404048

Senioren_1stam

Wertung

StartNr: 25

07.02.2026 14:04

SG_Breitenbach

Ergebnis: **418.3** (398)
 Serien: 104.4 103.8 105.1 105.0
 Zähler: 38 2 0 0 0 0 0 0 0 0
 Innenzehner: 37
 Weitester: 376 (20.), 348 (26.), 219 (10.)
 beste Teiler: 23.1 (22.), 24.0 (37.), 40.2 (23.)
 Trefferkreis: 9.82 mm
 Trefferlage: 0.43 mm rechts, 0.08 mm tief

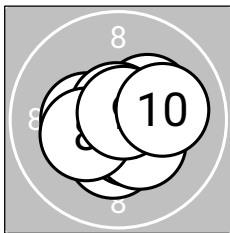
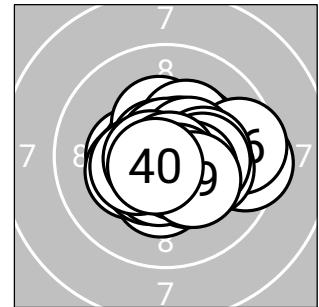
**Serie 1: 104.4** (100)

10.8*↑ 10.3*↗ 10.3*↓ 10.3*← 10.7*↑
 10.5*↓ 10.3*↘ 10.3*↖ 10.8*↗ 10.1*→

beste Teiler: 42.2 (9.), 48.7 (1.), 52.9 (5.)
 Trefferkreis: 8.38 mm
 Trefferlage: 0.18 mm rechts, 0.15 mm tief

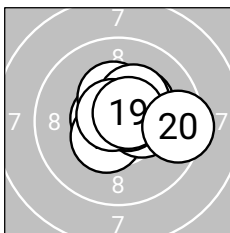
**Serie 2: 103.8** (99)

10.6*← 10.5*↙ 10.3*↑ 10.4*→ 10.3*↗
 10.7*↘ 10.3*↗ 10.7*↖ 10.6*↗ 9.4*→

beste Teiler: 55.1 (18.), 69.0 (16.), 78.1 (11.)
 Trefferkreis: 9.18 mm
 Trefferlage: 0.64 mm rechts, 0.40 mm hoch

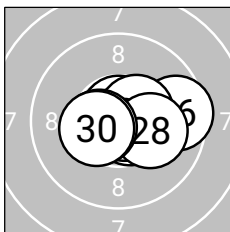
**Serie 3: 105.1** (99)

10.8*↑ 10.9*↓ 10.8*→ 10.6*→ 10.8*→
 9.6*→ 10.5*↗ 10.2*→ 10.5*← 10.4*←

beste Teiler: 23.1 (22.), 40.2 (23.), 40.4 (25.)
 Trefferkreis: 9.34 mm
 Trefferlage: 0.55 mm rechts, 0.08 mm tief

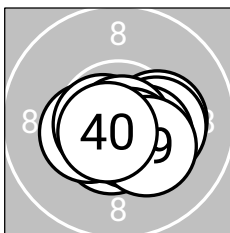
**Serie 4: 105.0** (100)

10.2*→ 10.3*→ 10.5*↓ 10.4*← 10.7*←
 10.4*↘ 10.9*↘ 10.6*↘ 10.3*↘ 10.7*↘

beste Teiler: 24.0 (37.), 68.5 (40.), 71.0 (35.)
 Trefferkreis: 7.64 mm
 Trefferlage: 0.37 mm rechts, 0.49 mm tief

Ergebnis: 418.6 (398)
Serien: 106.4 102.8 104.8 104.6
Zähler: 38 2 0 0 0 0 0 0 0 0
Innenzehner: 35
Weiteste: 295 (15.), 279 (19.), 234 (13.)
beste Teiler: 17.4 (7.), 28.8 (27.), 38.4 (37.)
Trefferkreis: 9.55 mm
Trefferlage: 0.34 mm rechts, 0.05 mm tief

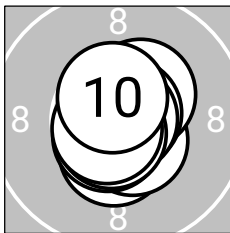
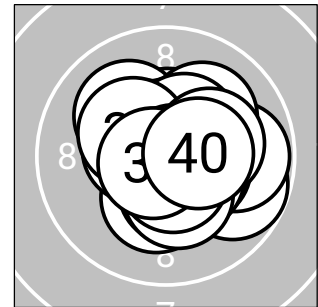

Serie 1: 106.4 (100)

10.4*↓	10.5*↘	10.4*↗	10.8*↗	10.8*↖
10.6*↙	10.9*→	10.7*↙	10.7*↖	10.6*↖

beste Teiler: 17.4 (7.), 43.4 (4.), 46.0 (5.)
Trefferkreis: 7.05 mm
Trefferlage: 0.02 mm rechts, 0.10 mm tief

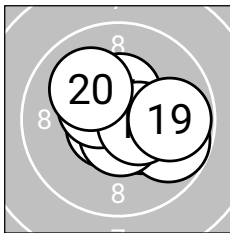

Serie 2: 102.8 (98)

10.4*↑	10.7*↖	10.0→	10.4*↘	9.8↘
10.6*↓	10.5*↖	10.5*→	9.8→	10.1↖

beste Teiler: 70.1 (12.), 83.0 (16.), 113.1 (18.)
Trefferkreis: 9.55 mm
Trefferlage: 0.73 mm rechts, 0.00 mm

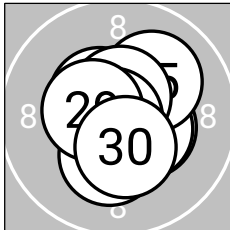

Serie 3: 104.8 (100)

10.4*↘	10.5*↖	10.5*↘	10.7*↖	10.1↗
10.6*↑	10.8*↖	10.3*↓	10.5*↖	10.4*↓

beste Teiler: 28.8 (27.), 60.2 (24.), 90.5 (26.)
Trefferkreis: 8.25 mm
Trefferlage: 0.12 mm rechts, 0.00 mm

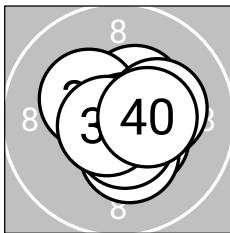

Serie 4: 104.6 (100)

10.5*→	10.4*↗	10.4*↘	10.3*↖	10.2*↗
10.3*↓	10.8*↘	10.6*↓	10.7*↖	10.4*→

beste Teiler: 38.4 (37.), 58.6 (39.), 91.0 (38.)
Trefferkreis: 7.85 mm
Trefferlage: 0.51 mm rechts, 0.12 mm tief



Ergebnis: **416.5** (396)
Serien: 104.1 105.4 102.9 104.1
Zähler: 36 4 0 0 0 0 0 0 0 0
Innenzehner: 35
Weiteste: 462 (10.), 375 (37.), 315 (26.)
beste Teiler: 40.4 (15.), 41.3 (11.), 41.5 (35.)
Trefferkreis: 12.28 mm
Trefferlage: 0.13 mm links, 0.15 mm tief

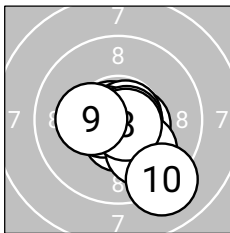
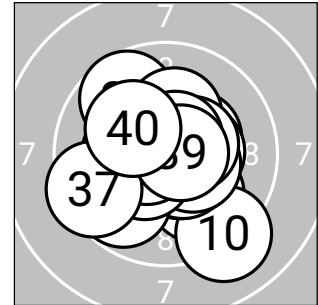

Serie 1: 104.1 (99)

10.5*➡	10.8*⬅	10.8*➡	10.6*↓	10.6*⬅
10.7*➡	10.0⬇	10.7*➡	10.3*⬅	9.1⬇

beste Teiler: 48.7 (2.), 49.6 (3.), 53.8 (6.)
Trefferkreis: 10.31 mm
Trefferlage: 0.35 mm rechts, 0.71 mm tief

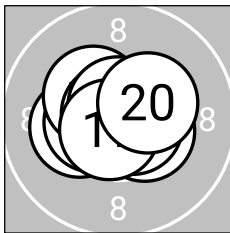

Serie 2: 105.4 (100)

10.8*⬇	10.2*⬅	10.5*⬅	10.3*⬅	10.8*⬅
10.7*↑	10.4*➡	10.7*➡	10.7*⬅	10.3*➡

beste Teiler: 40.4 (15.), 41.3 (11.), 56.0 (16.)
Trefferkreis: 7.74 mm
Trefferlage: 0.12 mm links, 0.05 mm hoch

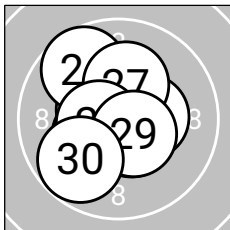

Serie 3: 102.9 (98)

10.5*⬇	10.4*↑	10.4*➡	10.5*⬅	10.4*⬅
9.7⬅	10.2*↑	10.5*⬅	10.5*➡	9.8⬅

beste Teiler: 103.5 (21.), 103.8 (28.), 112.2 (24.)
Trefferkreis: 9.52 mm
Trefferlage: 0.39 mm links, 0.15 mm hoch

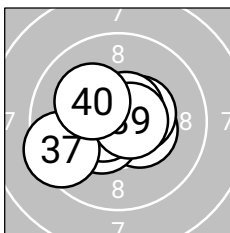

Serie 4: 104.1 (99)

10.4*➡	10.4*➡	10.5*⬅	10.4*⬅	10.8*➡
10.6*⬅	9.5⬅	10.6*⬅	10.7*➡	10.2*⬅

beste Teiler: 41.5 (35.), 70.2 (39.), 82.6 (38.)
Trefferkreis: 9.51 mm
Trefferlage: 0.38 mm links, 0.11 mm tief



Ergebnis: **409.0** (389)
 Serien: 102.8 101.8 103.0 101.4
 Zähler: 29 11 0 0 0 0 0 0 0 0
 Innenzehner: 24
 Weitester: 460 (17.), 391 (38.), 319 (2.)
 beste Teiler: 30.4 (16.), 40.0 (8.), 58.5 (37.)
 Trefferkreis: 11.89 mm
 Trefferlage: 0.26 mm links, 0.48 mm hoch

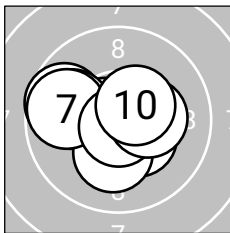
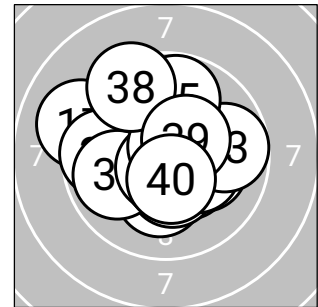

Serie 1: 102.8 (97)

10.4*↘	9.7↙	10.6*↓	10.7*↖	9.9↖
10.2*↓	9.8↖	10.8*↓	10.3*→	10.4*↗

beste Teiler: 40.0 (8.), 70.0 (4.), 85.2 (3.)
 Trefferkreis: 9.28 mm
 Trefferlage: 0.59 mm links, 0.08 mm tief

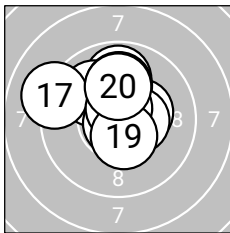

Serie 2: 101.8 (98)

9.9↑	10.0↖	10.3*→	10.0↑	10.5*→
10.8*↘	9.1↖	10.6*↑	10.5*↓	10.1↑

beste Teiler: 30.4 (16.), 76.1 (18.), 118.2 (19.)
 Trefferkreis: 10.38 mm
 Trefferlage: 0.30 mm links, 1.03 mm hoch

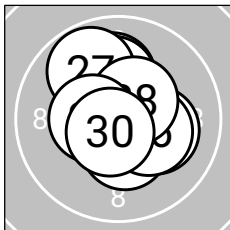

Serie 3: 103.0 (99)

10.1↑	10.2*→	10.6*↑	10.4*↓	10.1↑
10.3*→	9.8↖	10.5*↗	10.4*↖	10.6*↘

beste Teiler: 79.0 (30.), 98.4 (23.), 122.6 (28.)
 Trefferkreis: 8.96 mm
 Trefferlage: 0.09 mm rechts, 0.52 mm hoch

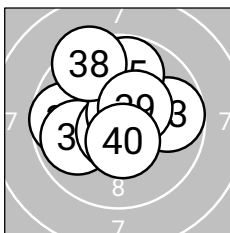

Serie 4: 101.4 (95)

9.7↖	9.9↖	9.7→	10.6*↓	9.8↑
10.7*↘	10.7*↗	9.4↖	10.4*↗	10.5*↓

beste Teiler: 58.5 (37.), 65.2 (36.), 93.1 (34.)
 Trefferkreis: 10.73 mm
 Trefferlage: 0.25 mm links, 0.46 mm hoch



Ergebnis: 401.5 (382)
Serien: 100.0 100.1 101.5 99.9
Zähler: 22 18 0 0 0 0 0 0 0 0
Innenzehner: 18
Weiteste: 479 (36.), 441 (27.), 427 (15.)
beste Teiler: 24.1 (24.), 62.0 (35.), 70.9 (13.)
Trefferkreis: 12.70 mm
Trefferlage: 0.14 mm links, 0.01 mm tief

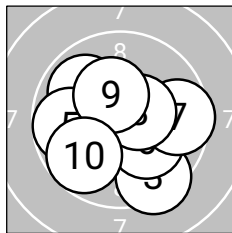
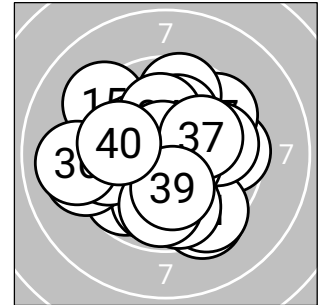

Serie 1: 100.0 (95)

9.9 ↙	10.3* →	9.4 ↘	10.3* ←	9.8 ←
10.2* ↘	9.6 →	10.5* →	10.3* ↖	9.7 ↗

beste Teiler: 117.0 (8.), 151.9 (2.), 156.9 (9.)
Trefferkreis: 10.97 mm
Trefferlage: 0.01 mm rechts, 0.37 mm tief

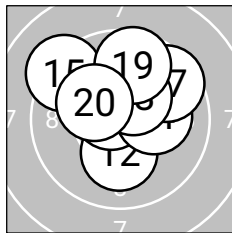

Serie 2: 100.1 (96)

10.1 ↑	10.2* ↓	10.7* ↙	10.2* →	9.2 ↘
9.9 ↗	9.6 ↗	10.3* ↗	9.7 ↑	10.2* ↙

beste Teiler: 70.9 (13.), 152.8 (18.), 180.8 (20.)
Trefferkreis: 10.94 mm
Trefferlage: 0.16 mm rechts, 1.34 mm hoch

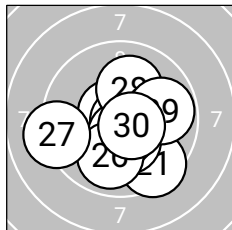

Serie 3: 101.5 (96)

9.5 ↘	10.7* ↙	10.3* ↓	10.9* →	10.5* ↓
9.9 ↓	9.2 ←	10.1 ↑	9.8 →	10.6* →

beste Teiler: 24.1 (24.), 73.7 (22.), 88.8 (30.)
Trefferkreis: 11.79 mm
Trefferlage: 0.15 mm rechts, 0.66 mm tief

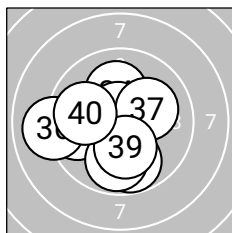

Serie 4: 99.9 (95)

9.8 ↓	9.7 ←	10.5* ↙	10.1 ↑	10.7* ↑
9.0 ←	10.1 →	9.9 ↓	10.2* ↓	9.9 ←

beste Teiler: 62.0 (35.), 109.6 (33.), 186.5 (39.)
Trefferkreis: 11.34 mm
Trefferlage: 0.90 mm links, 0.35 mm tief



Ergebnis: 418.9 (398)
Serien: 104.2 105.5 105.0 104.2
Zähler: 38 2 0 0 0 0 0 0 0 0
Innenzehner: 35
Weiteste: 267 (1.), 256 (2.), 243 (35.)
beste Teiler: 13.3 (16.), 36.0 (34.), 37.0 (26.)
Trefferkreis: 8.97 mm
Trefferlage: 0.22 mm rechts, 0.11 mm hoch

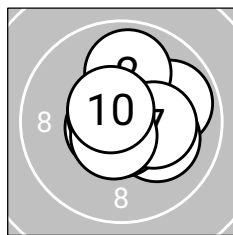
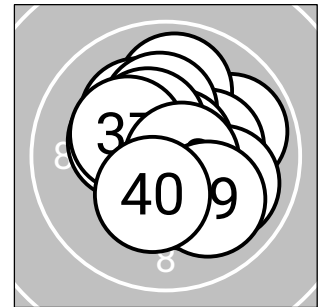

Serie 1: 104.2 (98)

9.9↗	9.9↑	10.1↘	10.7*↖	10.7*↖
10.7*↓	10.3*↗	10.7*↖	10.6*↘	10.6*↖

beste Teiler: 52.2 (5.), 62.0 (6.), 65.7 (8.)
Trefferkreis: 8.28 mm
Trefferlage: 0.39 mm rechts, 0.22 mm hoch

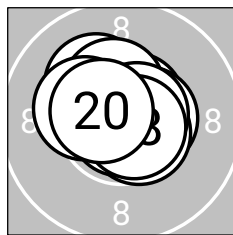

Serie 2: 105.5 (100)

10.2*↖	10.6*↗	10.5*↗	10.4*↑	10.6*↘
10.9*↓	10.7*↗	10.7*↘	10.3*↖	10.6*↖

beste Teiler: 13.3 (16.), 61.3 (18.), 73.8 (17.)
Trefferkreis: 7.29 mm
Trefferlage: 0.03 mm links, 0.42 mm hoch

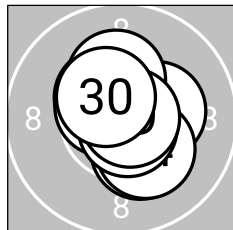

Serie 3: 105.0 (100)

10.3*↗	10.4*↖	10.3*↘	10.3*↘	10.6*↖
10.8*↗	10.2*↑	10.8*↘	10.8*↗	10.5*↖

beste Teiler: 37.0 (26.), 40.4 (29.), 47.0 (28.)
Trefferkreis: 7.92 mm
Trefferlage: 0.21 mm rechts, 0.16 mm hoch

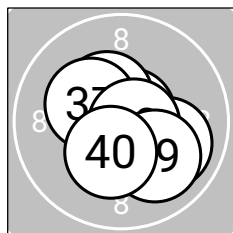

Serie 4: 104.2 (100)

10.2*↘	10.8*↘	10.7*↗	10.8*←	10.0↘
10.4*↖	10.3*↖	10.7*↗	10.0↘	10.3*↓

beste Teiler: 36.0 (34.), 40.8 (32.), 53.7 (33.)
Trefferkreis: 8.65 mm
Trefferlage: 0.33 mm rechts, 0.35 mm tief



LG 40 ZR

StandNr: 12

Casazza, Renate #70401048

Senioren_1staw

Wertung

StartNr: 1

07.02.2026 14:17

SG_Angerberg

Ergebnis: **417.2 (397)**
 Serien: 105.2 104.3 104.4 103.3
 Zähler: 37 3 0 0 0 0 0 0 0 0
 Innenzehner: 32
 Weitester: 338 (27.), 322 (12.), 282 (14.)
 beste Teiler: 19.3 (3.), 21.4 (13.), 32.5 (5.)
 Trefferkreis: 10.44 mm
 Trefferlage: 0.33 mm rechts, 0.05 mm tief

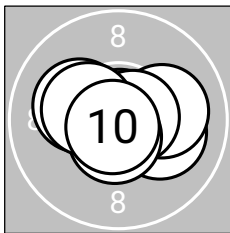
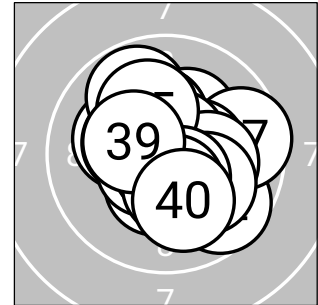

Serie 1: 105.2 (100)

10.7*↓	10.1→	10.9*↑	10.2*←	10.8*↘
10.1→	10.7*→	10.6*↓	10.3*←	10.8*↙

beste Teiler: 19.3 (3.), 32.5 (5.), 44.8 (10.)
 Trefferkreis: 8.58 mm
 Trefferlage: 0.15 mm rechts, 0.06 mm tief

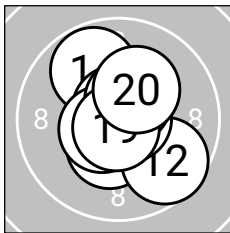

Serie 2: 104.3 (98)

10.4*↓	9.7↘	10.9*←	9.8↖	10.7*→
10.7*↑	10.6*←	10.5*↑	10.8*↓	10.2*↑

beste Teiler: 21.4 (13.), 43.6 (19.), 51.0 (15.)
 Trefferkreis: 10.44 mm
 Trefferlage: 0.13 mm rechts, 0.10 mm hoch

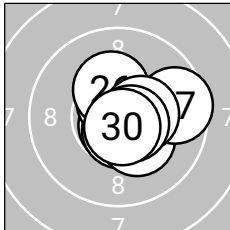

Serie 3: 104.4 (99)

10.5*→	10.8*↓	10.6*↓	10.6*↑	10.3*↘
10.3*↑	9.6→	10.4*→	10.6*↘	10.7*↓

beste Teiler: 50.0 (22.), 63.3 (30.), 78.7 (23.)
 Trefferkreis: 8.45 mm
 Trefferlage: 0.71 mm rechts, 0.02 mm tief

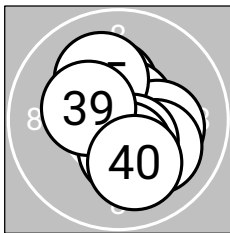

Serie 4: 103.3 (100)

10.6*↓	10.3*↑	10.7*↑	10.2*→	10.1↖
10.1↘	10.5*↘	10.4*↓	10.3*←	10.1↓

beste Teiler: 72.4 (33.), 85.0 (31.), 119.7 (37.)
 Trefferkreis: 8.77 mm
 Trefferlage: 0.34 mm rechts, 0.23 mm tief



Ergebnis: 412.1 (394)
Serien: 102.0 101.4 105.0 103.7
Zähler: 34 6 0 0 0 0 0 0 0 0
Innenzehner: 29
Weiteste: 325 (18.), 297 (3.), 291 (5.)
beste Teiler: 42.5 (21.), 47.0 (17.), 56.2 (29.)
Trefferkreis: 10.39 mm
Trefferlage: 0.12 mm links, 0.58 mm tief

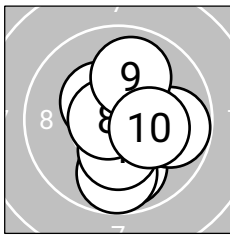
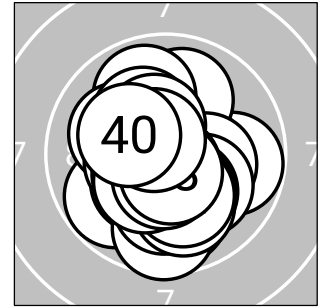

Serie 1: 102.0 (97)

9.9↓	10.4*→	9.8↓	10.3*↓	9.8→
10.4*↖	10.5*→	10.7*←	10.0↑	10.2*→

beste Teiler: 57.1 (8.), 111.3 (7.), 140.7 (6.)
Trefferkreis: 9.90 mm
Trefferlage: 0.67 mm rechts, 0.45 mm tief

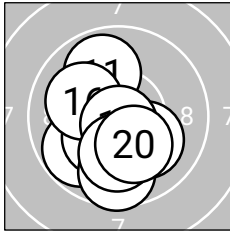

Serie 2: 101.4 (97)

9.9↑	10.1↘	9.8↖	10.4*↖	10.3*↖
10.1↖	10.8*↓	9.7↓	10.1↓	10.2*↘

beste Teiler: 47.0 (17.), 143.8 (14.), 160.3 (15.)
Trefferkreis: 10.32 mm
Trefferlage: 0.47 mm links, 0.96 mm tief

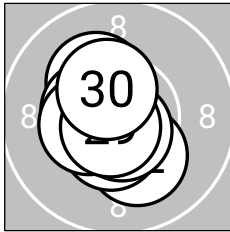

Serie 3: 105.0 (100)

10.8*↖	10.2*↘	10.5*↓	10.2*↖	10.7*↖
10.4*↖	10.4*←	10.7*↓	10.7*↖	10.4*↖

beste Teiler: 42.5 (21.), 56.2 (29.), 64.0 (28.)
Trefferkreis: 8.27 mm
Trefferlage: 0.44 mm links, 0.09 mm tief

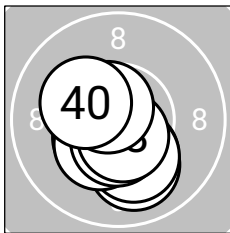

Serie 4: 103.7 (100)

10.2*↘	10.0↓	10.4*↖	10.2*↓	10.6*←
10.4*↖	10.5*↓	10.6*↓	10.6*↖	10.2*↖

beste Teiler: 80.1 (39.), 84.2 (38.), 85.0 (35.)
Trefferkreis: 8.35 mm
Trefferlage: 0.24 mm links, 0.82 mm tief



Ergebnis: 419.8 (399)
Serien: 105.9 103.5 106.2 104.2
Zähler: 39 1 0 0 0 0 0 0 0 0
Innenzehner: 36
Weiteste: 253 (13.), 246 (11.), 223 (37.)
beste Teiler: 12.3 (34.), 15.6 (15.), 23.2 (26.)
Trefferkreis: 9.37 mm
Trefferlage: 0.17 mm rechts, 0.18 mm hoch

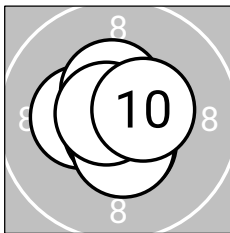
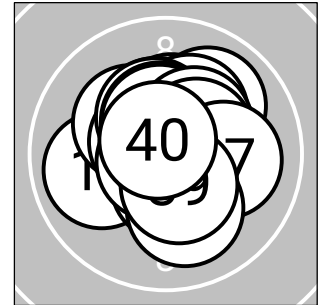

Serie 1: 105.9 (100)

10.5*↓	10.7*←	10.8*↓	10.7*↓	10.3*←
10.8*↓	10.5*↓	10.4*↑	10.7*↖	10.5*↗

beste Teiler: 46.4 (6.), 49.1 (3.), 52.0 (4.)
Trefferkreis: 7.22 mm
Trefferlage: 0.15 mm links, 0.15 mm tief

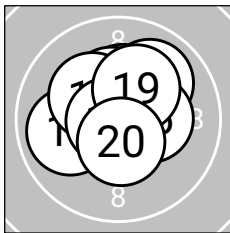

Serie 2: 103.5 (99)

10.0↗	10.3*↑	9.9←	10.4*↑	10.9*↗
10.3*→	10.2*↖	10.8*←	10.2*↗	10.5*↓

beste Teiler: 15.6 (15.), 44.9 (18.), 115.8 (20.)
Trefferkreis: 9.26 mm
Trefferlage: 0.00 mm , 0.59 mm hoch

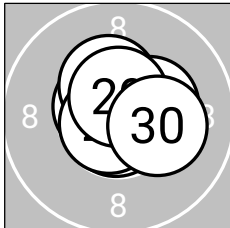

Serie 3: 106.2 (100)

10.8*↓	10.8*↓	10.6*↖	10.4*↑	10.8*→
10.9*↗	10.4*→	10.7*↖	10.6*↑	10.2*→

beste Teiler: 23.2 (26.), 33.2 (21.), 43.0 (25.)
Trefferkreis: 7.38 mm
Trefferlage: 0.20 mm rechts, 0.20 mm hoch

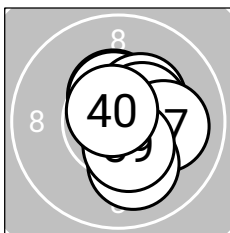

Serie 4: 104.2 (100)

10.4*↑	10.4*→	10.5*↑	10.9*→	10.3*↗
10.4*↗	10.1→	10.1↓	10.4*↓	10.7*↖

beste Teiler: 12.3 (34.), 61.4 (40.), 121.2 (33.)
Trefferkreis: 8.02 mm
Trefferlage: 0.64 mm rechts, 0.09 mm hoch



Ergebnis: **413.8** (395)
 Serien: 103.6 104.5 103.6 102.1
 Zähler: 35 5 0 0 0 0 0 0 0 0
 Innenzehner: 30
 Weitester: 444 (31.), 325 (4.), 277 (38.)
 beste Teiler: 36.7 (37.), 50.5 (3.), 51.9 (14.)
 Trefferkreis: 10.50 mm
 Trefferlage: 0.62 mm links, 0.20 mm hoch

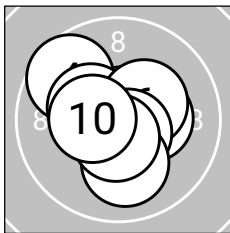
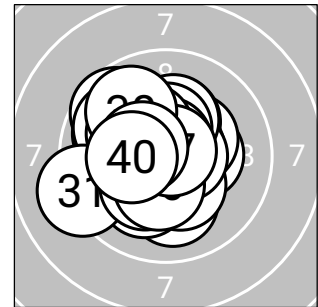

Serie 1: 103.6 (99)

10.5*→	10.3*→	10.8*↑	9.7↖	10.3*↖
10.3*↗	10.6*↘	10.1↓	10.6*↓	10.4*↖

beste Teiler: 50.5 (3.), 83.6 (7.), 92.9 (9.)
 Trefferkreis: 9.67 mm
 Trefferlage: 0.02 mm links, 0.04 mm hoch

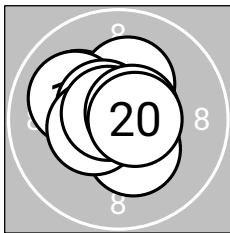

Serie 2: 104.5 (100)

10.1↖	10.3*↑	10.0↖	10.7*↓	10.6*↖
10.3*↘	10.5*↖	10.7*↖	10.7*↗	10.6*↗

beste Teiler: 51.9 (14.), 56.0 (18.), 74.2 (19.)
 Trefferkreis: 8.24 mm
 Trefferlage: 0.35 mm links, 0.26 mm hoch

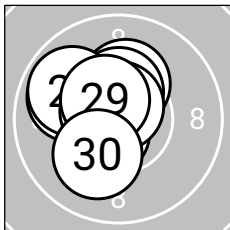

Serie 3: 103.6 (98)

10.2*↑	10.4*↑	10.6*↖	10.7*↖	9.9↖
9.9↖	10.6*↖	10.7*↑	10.5*↖	10.1↘

beste Teiler: 55.5 (24.), 65.1 (28.), 80.1 (27.)
 Trefferkreis: 8.44 mm
 Trefferlage: 0.78 mm links, 0.55 mm hoch

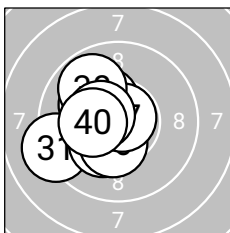

Serie 4: 102.1 (98)

9.2↖	10.3*↖	10.4*↘	10.3*↘	10.1↖
10.4*↓	10.8*↗	9.8↖	10.5*↖	10.3*↖

beste Teiler: 36.7 (37.), 123.7 (39.), 145.0 (36.)
 Trefferkreis: 9.40 mm
 Trefferlage: 1.32 mm links, 0.04 mm tief



LG 40 ZR

StandNr: 10

Kavelar, Christine #70406020

Senioren_1staw

Wertung

StartNr: 31

07.02.2026 13:57

SG_Bruckhäusl

Ergebnis: **413.3** (393)
 Serien: 103.8 102.9 103.0 103.6
 Zähler: 33 7 0 0 0 0 0 0 0 0
 Innenzehner: 28
 Weitester: 367 (28.), 320 (29.), 291 (15.)
 beste Teiler: 31.9 (18.), 38.3 (33.), 42.5 (9.)
 Trefferkreis: 10.78 mm
 Trefferlage: 0.31 mm rechts, 0.29 mm tief

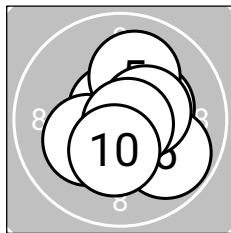
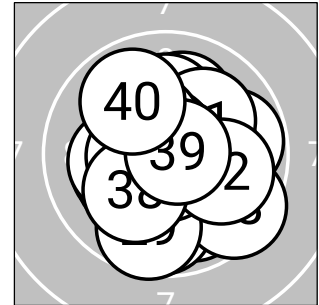
**Serie 1: 103.8** (99)

10.7*↖	10.8*↘	10.4*↘	10.3*→	10.1↗
9.8↘	10.4*→	10.2*↖	10.8*↘	10.3*↓

beste Teiler: 42.5 (9.), 50.2 (2.), 57.6 (1.)
 Trefferkreis: 9.04 mm
 Trefferlage: 0.52 mm rechts, 0.17 mm tief

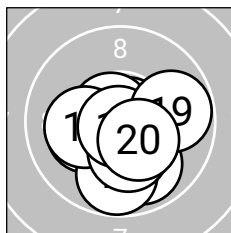
**Serie 2: 102.9** (97)

9.9↘	10.8*→	10.7*↖	10.2*↖	9.8↓
10.2*↖	10.3*↓	10.8*↓	9.8→	10.4*↘

beste Teiler: 31.9 (18.), 43.3 (12.), 68.1 (13.)
 Trefferkreis: 9.50 mm
 Trefferlage: 0.12 mm rechts, 0.79 mm tief

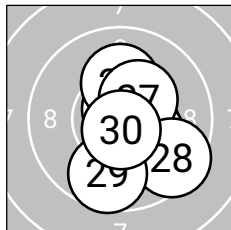
**Serie 3: 103.0** (98)

10.5*↘	10.4*↘	10.7*→	10.7*↑	10.1↑
10.3*↘	10.4*↗	9.5↘	9.7↓	10.7*↓

beste Teiler: 57.3 (24.), 62.2 (30.), 65.1 (23.)
 Trefferkreis: 10.07 mm
 Trefferlage: 0.74 mm rechts, 0.45 mm tief

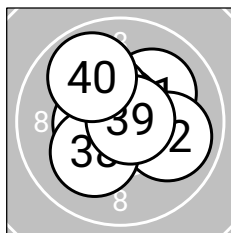
**Serie 4: 103.6** (99)

10.1↗	10.0→	10.8*↑	10.7*↑	10.4*↖
10.4*↖	10.5*↖	10.1↖	10.7*→	9.9↖

beste Teiler: 38.3 (33.), 51.9 (39.), 61.3 (34.)
 Trefferkreis: 9.43 mm
 Trefferlage: 0.12 mm links, 0.26 mm hoch

Ergebnis: 419.6 (399)
Serien: 104.3 105.0 104.8 105.5
Zähler: 39 1 0 0 0 0 0 0 0 0
Innenzehner: 31
Weiteste: 253 (23.), 234 (7.), 220 (40.)
beste Teiler: 14.7 (35.), 20.6 (17.), 27.7 (5.)
Trefferkreis: 9.11 mm
Trefferlage: 0.25 mm links, 0.16 mm tief

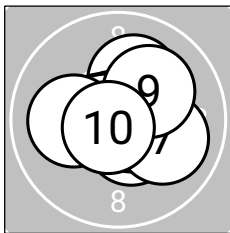
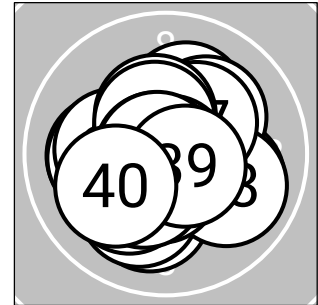

Serie 1: 104.3 (100)

10.5*↘	10.7*↘	10.1↗	10.6*←	10.8*↖
10.7*←	10.0↘	10.1←	10.1↗	10.7*↘

beste Teiler: 27.7 (5.), 62.0 (6.), 62.0 (10.)
Trefferkreis: 8.95 mm
Trefferlage: 0.12 mm rechts, 0.07 mm hoch

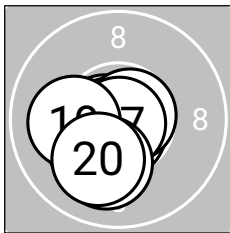

Serie 2: 105.0 (100)

10.7*↘	10.7*↓	10.7*←	10.8*↖	10.2*↘
10.7*↗	10.9*↓	10.1↓	10.1←	10.1↘

beste Teiler: 20.6 (17.), 46.1 (14.), 58.3 (11.)
Trefferkreis: 7.52 mm
Trefferlage: 0.54 mm links, 0.70 mm tief

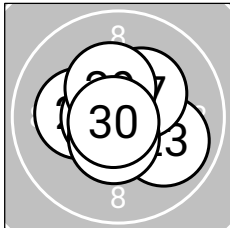

Serie 3: 104.8 (99)

10.6*↖	10.8*↘	9.9↘	10.6*↗	10.2*←
10.7*←	10.3*↗	10.5*↓	10.4*↗	10.8*↘

beste Teiler: 34.6 (30.), 42.7 (22.), 59.0 (26.)
Trefferkreis: 8.85 mm
Trefferlage: 0.05 mm links, 0.15 mm hoch

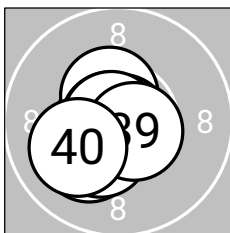

Serie 4: 105.5 (100)

10.7*←	10.5*↗	10.5*↗	10.2*↘	10.9*↘
10.8*←	10.4*↘	10.8*←	10.6*↘	10.1←

beste Teiler: 14.7 (35.), 32.5 (38.), 38.2 (36.)
Trefferkreis: 7.43 mm
Trefferlage: 0.52 mm links, 0.19 mm tief



Ergebnis: **409.3** (390)
 Serien: 103.0 102.0 103.5 100.8
 Zähler: 30 10 0 0 0 0 0 0 0 0
 Innenzehner: 25
 Weitester: 432 (36.), 423 (32.), 395 (7.)
 beste Teiler: 8.0 (28.), 19.9 (14.), 27.4 (33.)
 Trefferkreis: 11.86 mm
 Trefferlage: 0.37 mm rechts, 0.11 mm hoch

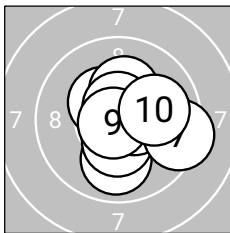
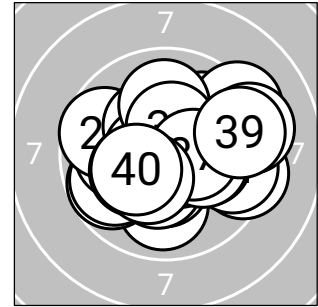

Serie 1: 103.0 (99)

10.4*↖	10.0↓	10.7*↓	10.4*↓	10.5*→
10.2*↑	9.4→	10.6*↑	10.8*↙	10.0→

beste Teiler: 38.2 (9.), 69.4 (3.), 79.0 (8.)
 Trefferkreis: 9.78 mm
 Trefferlage: 0.58 mm rechts, 0.14 mm tief

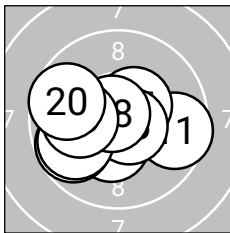

Serie 2: 102.0 (96)

9.6→	10.4*↓	9.7↙	10.9*↑	10.5*↗
10.6*↘	9.8↙	10.8*↖	10.0←	9.7↙

beste Teiler: 19.9 (14.), 50.3 (18.), 76.3 (16.)
 Trefferkreis: 11.08 mm
 Trefferlage: 0.64 mm links, 0.28 mm tief

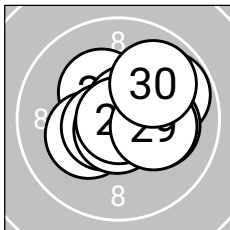

Serie 3: 103.5 (98)

10.3*↖	9.8↗	10.1→	10.7*↗	10.3*↙
10.6*↙	10.7*↓	10.9*↘	10.2*→	9.9↗

beste Teiler: 8.0 (28.), 57.3 (27.), 75.6 (24.)
 Trefferkreis: 9.07 mm
 Trefferlage: 0.55 mm rechts, 0.24 mm hoch

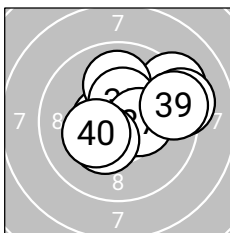

Serie 4: 100.8 (97)

10.6*←	9.3↗	10.8*↗	10.0↑	10.4*↑
9.2→	10.4*→	10.4*↙	9.4→	10.3*↙

beste Teiler: 27.4 (33.), 83.2 (31.), 134.9 (35.)
 Trefferkreis: 10.46 mm
 Trefferlage: 0.99 mm rechts, 0.66 mm hoch



Ergebnis: 414.8 (398)
Serien: 102.9 104.9 104.0 103.0
Zähler: 38 2 0 0 0 0 0 0 0 0
Innenzehner: 28
Weiteste: 280 (29.), 252 (36.), 246 (4.)
beste Teiler: 14.0 (11.), 40.1 (30.), 41.9 (18.)
Trefferkreis: 8.60 mm
Trefferlage: 0.97 mm links, 0.36 mm hoch

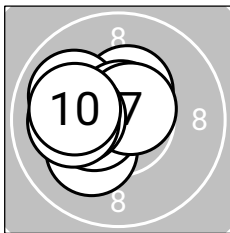
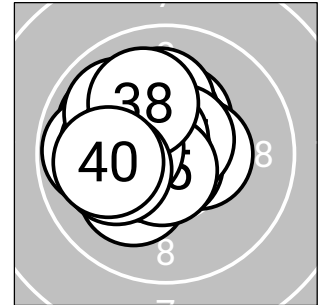

Serie 1: 102.9 (100)

10.2*↙	10.1↖	10.4*↗	10.0↖	10.7*↗
10.5*↙	10.6*↗	10.2*↖	10.1↖	10.1↖

beste Teiler: 66.0 (5.), 80.7 (7.), 120.6 (6.)
Trefferkreis: 7.96 mm
Trefferlage: 1.18 mm links, 0.32 mm hoch

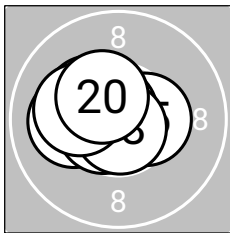

Serie 2: 104.9 (100)

10.9*→	10.4*↖	10.1↖	10.6*↖	10.4*→
10.8*↖	10.3*↖	10.8*↓	10.2*↖	10.4*↖

beste Teiler: 14.0 (11.), 41.9 (18.), 48.7 (16.)
Trefferkreis: 7.95 mm
Trefferlage: 0.69 mm links, 0.18 mm hoch

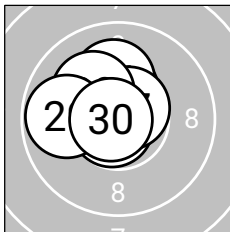

Serie 3: 104.0 (99)

10.4*↖	10.7*↖	10.8*↖	10.4*↑	10.2*↖
10.1↑	10.6*↗	10.2*↖	9.8↖	10.8*↖

beste Teiler: 40.1 (30.), 50.2 (23.), 60.0 (22.)
Trefferkreis: 7.91 mm
Trefferlage: 0.79 mm links, 0.71 mm hoch

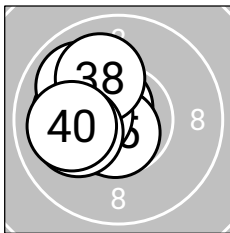

Serie 4: 103.0 (99)

10.6*↖	10.1↖	10.6*↖	10.7*↖	10.7*↓
9.9↖	10.3*↖	10.0↖	10.1↖	10.0↖

beste Teiler: 62.6 (34.), 67.6 (35.), 77.9 (31.)
Trefferkreis: 7.56 mm
Trefferlage: 1.24 mm links, 0.22 mm hoch



Ergebnis: 413.7 (396)
Serien: 102.9 104.3 103.1 103.4
Zähler: 36 4 0 0 0 0 0 0 0 0
Innenzehner: 29
Weiteste: 330 (1.), 324 (32.), 299 (2.)
beste Teiler: 20.8 (9.), 29.0 (5.), 35.7 (37.)
Trefferkreis: 10.13 mm
Trefferlage: 0.15 mm links, 0.17 mm hoch

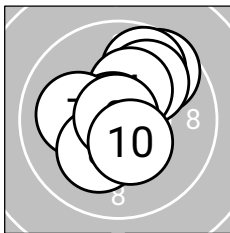
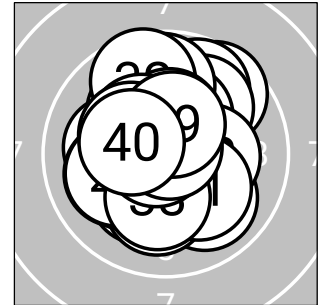

Serie 1: 102.9 (98)

9.6 ↗	9.8 ↗	10.0 ↗	10.3* ↗	10.8* ←
10.8* ↘	10.1 ←	10.2* ↘	10.9* ↘	10.4* ↓

beste Teiler: 20.8 (9.), 29.0 (5.), 38.9 (6.)
Trefferkreis: 9.71 mm
Trefferlage: 0.23 mm rechts, 0.66 mm hoch

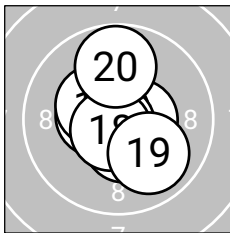

Serie 2: 104.3 (99)

10.5* →	10.7* ↘	10.5* ↓	10.4* ↓	10.5* ←
10.8* ↘	10.4* ↘	10.7* ↘	10.0 ↘	9.8 ↑

beste Teiler: 38.8 (16.), 56.7 (12.), 71.8 (18.)
Trefferkreis: 9.61 mm
Trefferlage: 0.04 mm links, 0.10 mm tief

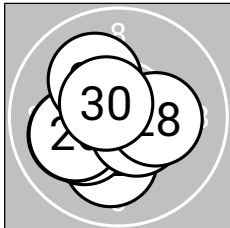

Serie 3: 103.1 (100)

10.8* ↘	10.1 ↓	10.2* ↘	10.5* →	10.0 ←
10.1 ←	10.5* →	10.2* →	10.1 ↘	10.6* ↘

beste Teiler: 49.4 (21.), 87.7 (30.), 106.5 (27.)
Trefferkreis: 8.57 mm
Trefferlage: 0.45 mm links, 0.39 mm tief

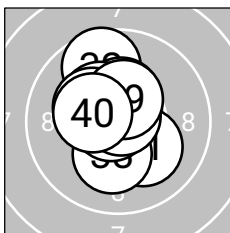

Serie 4: 103.4 (99)

10.2* ↘	9.7 ↑	10.2* ↓	10.4* ↑	10.3* ↘
10.8* ←	10.8* ↗	10.3* ↘	10.4* ↑	10.3* ←

beste Teiler: 35.7 (37.), 41.0 (36.), 129.2 (39.)
Trefferkreis: 9.64 mm
Trefferlage: 0.36 mm links, 0.52 mm hoch



Ergebnis: 413.6 (393)
Serien: 103.4 103.3 105.5 101.4
Zähler: 33 7 0 0 0 0 0 0 0 0
Innenzehner: 29
Weiteste: 358 (36.), 347 (37.), 319 (31.)
beste Teiler: 14.7 (26.), 23.8 (21.), 38.1 (40.)
Trefferkreis: 11.09 mm
Trefferlage: 0.15 mm links, 0.03 mm hoch

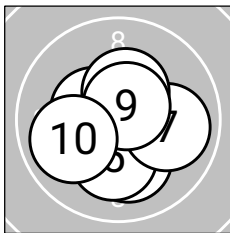
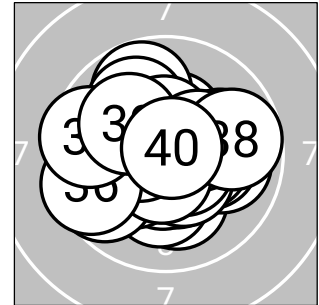

Serie 1: 103.4 (99)

10.8*↘	10.4*←	10.6*→	10.1↓	10.2*↓
10.4*←	10.0→	10.4*↑	10.6*↑	9.9↙

beste Teiler: 44.4 (1.), 81.6 (9.), 95.7 (3.)
Trefferkreis: 9.33 mm
Trefferlage: 0.01 mm links, 0.27 mm tief

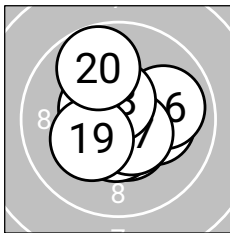

Serie 2: 103.3 (98)

10.2*→	10.5*↓	10.5*↓	10.7*↑	10.5*←
9.9→	10.5*↘	10.5*↑	10.2*↙	9.8↖

beste Teiler: 68.3 (14.), 103.2 (17.), 103.8 (18.)
Trefferkreis: 9.19 mm
Trefferlage: 0.18 mm rechts, 0.14 mm hoch

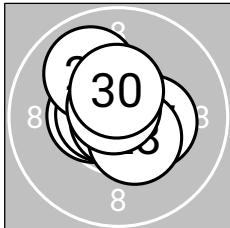

Serie 3: 105.5 (100)

10.9*↘	10.5*←	10.6*←	10.0↖	10.6*↑
10.9*↙	10.3*→	10.5*↘	10.7*↖	10.5*↑

beste Teiler: 14.7 (26.), 23.8 (21.), 52.8 (29.)
Trefferkreis: 8.24 mm
Trefferlage: 0.10 mm links, 0.33 mm hoch

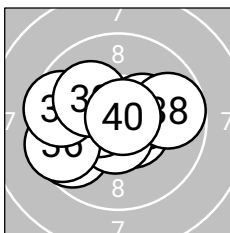

Serie 4: 101.4 (96)

9.7↙	10.6*↘	10.3*→	10.6*↓	10.5*←
9.5↙	9.6←	9.7→	10.1↖	10.8*↑

beste Teiler: 38.1 (40.), 85.9 (34.), 94.3 (32.)
Trefferkreis: 11.09 mm
Trefferlage: 0.69 mm links, 0.05 mm tief

