

Ergebnis: **302.9** (289)
 Serien: 101.0 100.5 101.4
 Zähler: 19 11 0 0 0 0 0 0 0 0
 Innenzehner: 15
 Weitester: 407 (16.), 402 (14.), 399 (4.)
 beste Teiler: 6.0 (13.), 18.2 (19.), 51.5 (11.)
 Trefferkreis: 12.50 mm
 Trefferlage: 0.10 mm links, 0.88 mm hoch

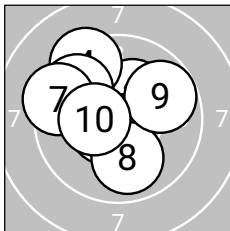
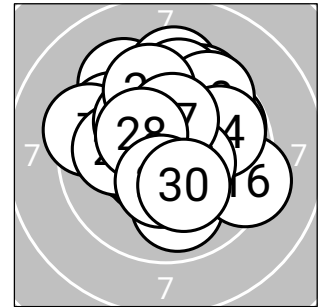

Serie 1: 101.0 (96)

10.6*↖	10.7*↓	10.3*↗	9.4↖	10.7*↓
9.7↖	9.4↖	10.0↓	9.8↗	10.4*↖

beste Teiler: 69.3 (5.), 75.4 (2.), 99.2 (1.)
 Trefferkreis: 11.01 mm
 Trefferlage: 0.66 mm links, 0.48 mm hoch

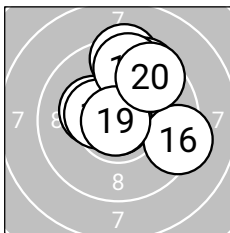

Serie 2: 100.5 (95)

10.7*↖	10.3*↖	10.9*↖	9.3↑	9.5↗
9.3↗	10.4*↖	9.6↑	10.9*↖	9.6↗

beste Teiler: 6.0 (13.), 18.2 (19.), 51.5 (11.)
 Trefferkreis: 10.94 mm
 Trefferlage: 0.53 mm rechts, 1.36 mm hoch

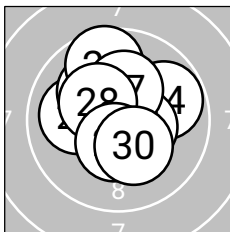

Serie 3: 101.4 (98)

10.1↖	10.0↖	10.1↖	9.8↗	10.5*↗
9.7↖	10.2*↑	10.3*↖	10.4*↓	10.3*↘

beste Teiler: 121.1 (25.), 128.8 (29.), 155.9 (28.)
 Trefferkreis: 9.50 mm
 Trefferlage: 0.17 mm links, 0.79 mm hoch



ISSF AR Mixed Final

StandNr: G

Entner, Lorena #70404054

offene Klasse

Medal Match

StartNr: 7

06.02.2026 20:07

SG_Breitenbach

SG Breitenbach 1

Ergebnis: **141.5** (135)
Serien: 49.4 50.6 41.5
Zähler: 9 5 0 0 0 0 0 0 0 0
Innenzehner: 7
Weiteste: 447 (5.), 438 (12.), 356 (8.)
beste Teiler: 10.0 (14.), 45.2 (11.), 63.5 (6.)
Trefferkreis: 12.90 mm
Trefferlage: 0.48 mm links, 0.20 mm tief

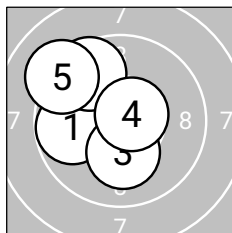
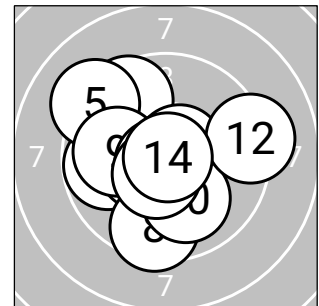

Serie 1: 49.4 (47)

9.8 ← 9.6 ↖ 10.2* ↓ 10.6* ↗ 9.2 ↖
beste Teiler: 79.7 (4.), 191.7 (3.), 294.7 (1.)
Trefferkreis: 10.43 mm
Trefferlage: 1.50 mm links, 0.73 mm hoch

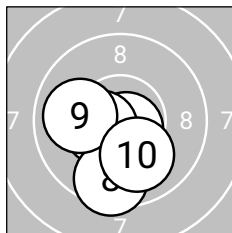

Serie 2: 50.6 (49)

10.7* ↘ 10.4* ← 9.5 ↓ 10.0 ← 10.0 ↓
beste Teiler: 63.5 (6.), 127.4 (7.), 230.3 (10.)
Trefferkreis: 8.85 mm
Trefferlage: 0.57 mm links, 1.25 mm tief

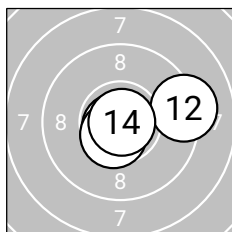

Serie 3: 41.5 (39)

10.8* ↖ 9.2 → 10.6* ↘ 10.9* →
beste Teiler: 10.0 (14.), 45.2 (11.), 96.6 (13.)
Trefferkreis: 9.57 mm
Trefferlage: 0.89 mm rechts, 0.05 mm tief



Ergebnis: **315.3** (298)
 Serien: 105.8 105.7 103.8
 Zähler: 28 2 0 0 0 0 0 0 0 0
 Innenezehner: 25
 Weitestе: 299 (29.), 255 (22.), 243 (9.)
 beste Teiler: 22.0 (8.), 27.2 (6.), 33.5 (11.)
 Trefferkreis: 10.04 mm
 Trefferlage: 0.10 mm links, 0.10 mm hoch

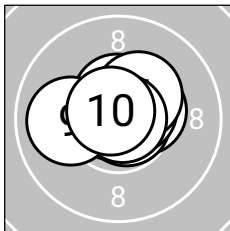
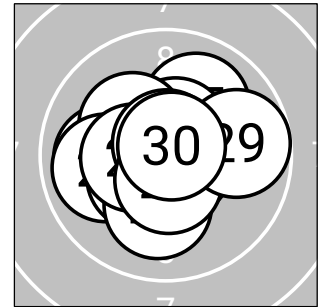

Serie 1: 105.8 (100)

10.4*➔	10.8*➤	10.8*↑	10.5*↑	10.6*➤
10.8*↙	10.3*↗	10.9*➔	10.0←	10.7*↙

beste Teiler: 22.0 (8.), 27.2 (6.), 35.1 (3.)
 Trefferkreis: 8.21 mm
 Trefferlage: 0.05 mm rechts, 0.37 mm hoch

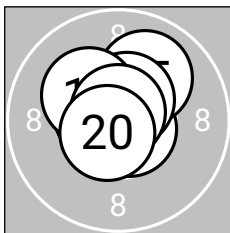

Serie 2: 105.7 (100)

10.8*↙	10.7*➤	10.7*↑	10.8*←	10.0↗
10.6*↙	10.5*↗	10.2*↙	10.8*↑	10.6*↙

beste Teiler: 33.5 (11.), 35.0 (14.), 40.0 (19.)
 Trefferkreis: 7.69 mm
 Trefferlage: 0.11 mm links, 0.43 mm hoch

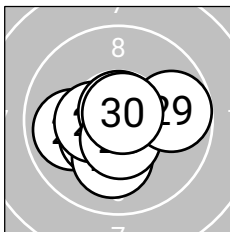

Serie 3: 103.8 (98)

10.6*↙	9.9←	10.5*↓	10.4*↙	10.1↓
10.4*←	10.8*↑	10.5*↓	9.8➔	10.8*↗

beste Teiler: 44.9 (30.), 48.0 (27.), 82.1 (21.)
 Trefferkreis: 10.04 mm
 Trefferlage: 0.26 mm links, 0.49 mm tief



ISSF AR Mixed Final

StandNr: H

Entner, Patrick #70404036

offene Klasse

Medal Match

StartNr: 8

06.02.2026 20:07

SG_Breitenbach

SG Breitenbach 1

Ergebnis: **145.3** (138)
 Serien: 52.5 52.2 40.6
 Zähler: 12 2 0 0 0 0 0 0 0 0
 Innenzehner: 10
 Weitest: 259 (14.), 254 (11.), 234 (10.)
 beste Teiler: 20.8 (9.), 56.8 (2.), 60.0 (12.)
 Trefferkreis: 8.17 mm
 Trefferlage: 0.63 mm rechts, 0.36 mm hoch

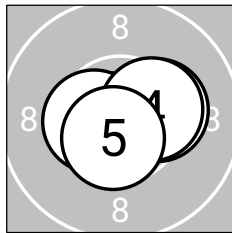
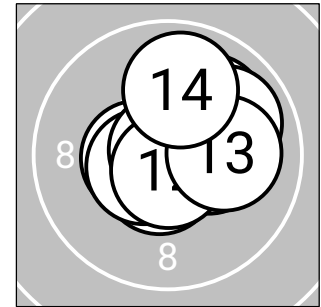
**Serie 1: 52.5** (50)

10.3*→

10.7*←

10.5*←

10.4*→

10.6*↓

beste Teiler: 56.8 (2.), 89.8 (5.), 115.5 (3.)
 Trefferkreis: 7.29 mm
 Trefferlage: 0.19 mm rechts, 0.07 mm tief

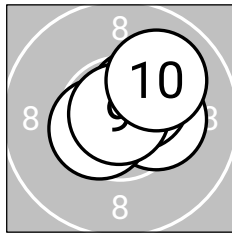
**Serie 2: 52.2** (50)

10.3*→

10.5*↗

10.5*←

10.9*↖

10.0↗

beste Teiler: 20.8 (9.), 104.2 (8.), 117.4 (7.)
 Trefferkreis: 7.84 mm
 Trefferlage: 0.60 mm rechts, 0.45 mm hoch

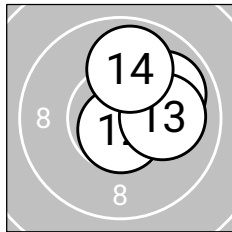
**Serie 3: 40.6** (38)

9.9↗

10.7*↓

10.1→

9.9↑

beste Teiler: 60.0 (12.), 220.1 (13.), 254.7 (11.)
 Trefferkreis: 7.83 mm
 Trefferlage: 1.23 mm rechts, 0.82 mm hoch

Ergebnis: **311.6** (296)
 Serien: 104.1 104.1 103.4
 Zähler: 26 4 0 0 0 0 0 0 0 0
 Innenezehner: 26
 Weitestе: 347 (27.), 279 (14.), 277 (16.)
 beste Teiler: 16.0 (19.), 18.4 (12.), 34.1 (2.)
 Trefferkreis: 9.87 mm
 Trefferlage: 0.27 mm links, 0.04 mm hoch

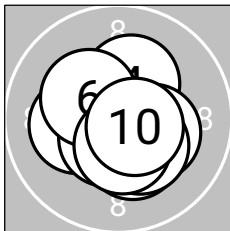
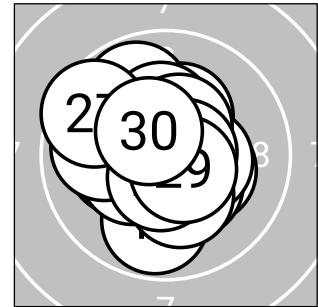

Serie 1: 104.1 (100)

10.2*←	10.8*↓	10.5*↙	10.3*↗	10.3*↓
10.3*↖	10.3*↗	10.3*↘	10.5*↓	10.6*↘

beste Teiler: 34.1 (2.), 84.5 (10.), 101.7 (3.)
 Trefferkreis: 8.07 mm
 Trefferlage: 0.10 mm rechts, 0.38 mm tief

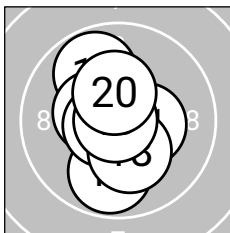

Serie 2: 104.1 (98)

10.4*→	10.9*↙	10.6*↖	9.8↖	10.4*←
9.8↓	10.6*←	10.3*↓	10.9*←	10.4*↑

beste Teiler: 16.0 (19.), 18.4 (12.), 78.4 (17.)
 Trefferkreis: 9.81 mm
 Trefferlage: 0.27 mm links, 0.01 mm hoch

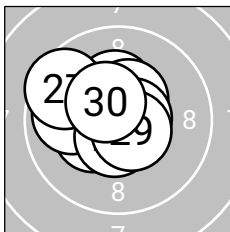

Serie 3: 103.4 (98)

10.5*↖	10.3*↑	10.3*←	9.9←	10.4*↗
10.7*→	9.6↖	10.6*↓	10.6*↘	10.5*↖

beste Teiler: 75.8 (26.), 93.8 (29.), 95.3 (28.)
 Trefferkreis: 8.90 mm
 Trefferlage: 0.65 mm links, 0.49 mm hoch



ISSF AR Mixed Final

StandNr: E

Wiciak, Martina #80001359**offene Klasse**

Medal Match

StartNr: 5

06.02.2026 20:07

SG_Bruckhäusl

SG Bruckhäusl 1

Ergebnis: **141.9** (138)
 Serien: 51.5 51.6 38.8
 Zähler: 12 2 0 0 0 0 0 0 0 0
 Innenzehner: 9
 Weitest: 465 (14.), 369 (11.), 241 (12.)
 beste Teiler: 107.8 (2.), 108.4 (5.), 122.1 (6.)
 Trefferkreis: 10.89 mm
 Trefferlage: 0.41 mm rechts, 0.76 mm tief

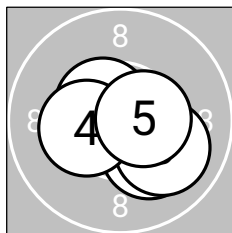
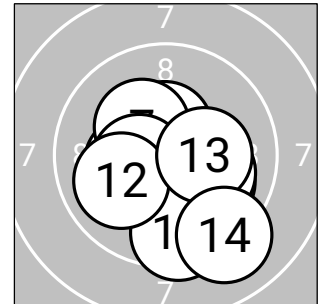
**Serie 1: 51.5** (50)

10.2*↘

10.5*↖

10.0↗

10.3*←

10.5*→

beste Teiler: 107.8 (2.), 108.4 (5.), 161.6 (4.)

Trefferkreis: 8.16 mm

Trefferlage: 0.39 mm rechts, 0.44 mm tief

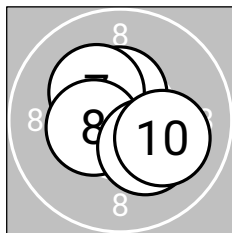
**Serie 2: 51.6** (50)

10.5*↑

10.3*↖

10.4*←

10.3*↘

10.1↗

beste Teiler: 122.1 (6.), 129.2 (8.), 171.8 (9.)

Trefferkreis: 8.28 mm

Trefferlage: 0.14 mm rechts, 0.02 mm hoch

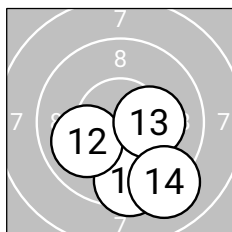
**Serie 3: 38.8** (38)

9.5↓

10.0↖

10.2*→

9.1↘

beste Teiler: 182.0 (13.), 241.0 (12.), 369.7 (11.)

Trefferkreis: 9.98 mm

Trefferlage: 0.76 mm rechts, 2.15 mm tief

ISSF AR Mixed

StandNr: 4

Fuchs, Manfred_jun. #70406038

offene Klasse

Competition

StartNr: 256

06.02.2026 18:17

SG_Bruckhäusl

SG Bruckhäusl 1

Ergebnis: **307.8** (295)
 Serien: 102.7 103.8 101.3
 Zähler: 25 5 0 0 0 0 0 0 0 0 0
 Innenezehner: 17
 Weitest: 431 (3.), 347 (1.), 346 (28.)
 beste Teiler: 38.2 (16.), 38.8 (5.), 46.3 (13.)
 Trefferkreis: 12.01 mm
 Trefferlage: 0.15 mm rechts, 0.34 mm hoch

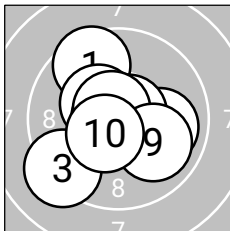
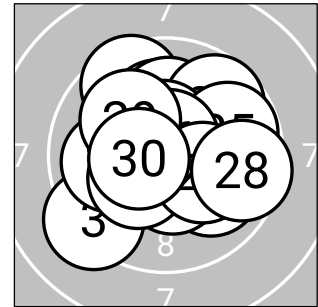

Serie 1: 102.7 (98)

9.6 ↗	10.0 →	9.2 ↘	10.4* ↖	10.8* ↙
10.8* ←	10.7* ↗	10.7* ↘	10.0 →	10.5* ↙

beste Teiler: 38.8 (5.), 48.0 (6.), 65.0 (8.)
 Trefferkreis: 11.33 mm
 Trefferlage: 0.28 mm links, 0.09 mm tief

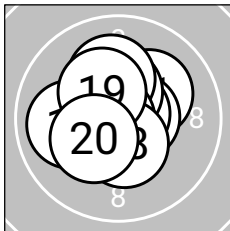

Serie 2: 103.8 (100)

10.1 ↗	10.6* →	10.8* ↗	10.4* ↑	10.1 ↑
10.8* ←	10.0 ←	10.4* ↓	10.3* ↖	10.3* ↙

beste Teiler: 38.2 (16.), 46.3 (13.), 89.3 (12.)
 Trefferkreis: 8.79 mm
 Trefferlage: 0.20 mm links, 0.36 mm hoch

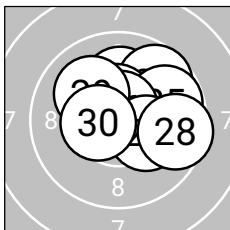

Serie 3: 101.3 (97)

10.1 ↑	10.1 →	9.7 ↗	10.5* ↑	9.8 →
10.7* ↑	10.2* ↗	9.6 →	10.1 ↖	10.5* ←

beste Teiler: 70.2 (26.), 110.7 (24.), 121.0 (30.)
 Trefferkreis: 9.98 mm
 Trefferlage: 0.95 mm rechts, 0.74 mm hoch



ISSF AR Mixed Final

StandNr: F

Fuchs, Manfred_jun. #70406038**offene Klasse**

Medal Match

StartNr: 6

06.02.2026 20:07

SG_Bruckhäusl

SG Bruckhäusl 1

Ergebnis: **142.0** (134)
 Serien: 49.6 51.8 40.6
 Zähler: 8 6 0 0 0 0 0 0 0 0
 Innenezehner: 8
 Weitest: 416 (1.), 373 (3.), 319 (12.)
 beste Teiler: 36.0 (6.), 66.4 (2.), 72.0 (13.)
 Trefferkreis: 11.05 mm
 Trefferlage: 0.56 mm links, 0.56 mm hoch

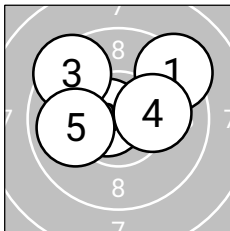
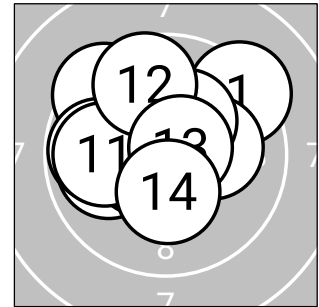
**Serie 1: 49.6** (47)

9.3↗

10.7*←

9.5↖

10.2*→

9.9←

beste Teiler:

66.4 (2.), 200.8 (4.), 252.9 (5.)

Trefferkreis:

11.01 mm

Trefferlage:

0.12 mm links, 1.04 mm hoch

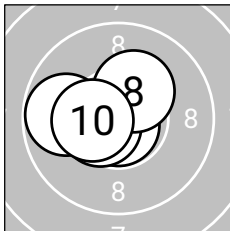
**Serie 2: 51.8** (49)

10.8*↓

10.5*←

10.3*↗

9.8←

10.4*←

beste Teiler:

36.0 (6.), 105.4 (7.), 142.4 (10.)

Trefferkreis:

8.42 mm

Trefferlage:

0.88 mm links, 0.16 mm hoch

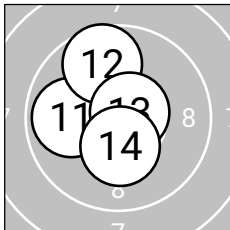
**Serie 3: 40.6** (38)

9.9←

9.7↗

10.7*↗

10.3*↓

beste Teiler:

72.0 (13.), 159.3 (14.), 265.0 (11.)

Trefferkreis:

9.26 mm

Trefferlage:

0.70 mm links, 0.46 mm hoch

Ergebnis: **297.4** (286)
 Serien: 101.1 98.3 98.0
 Zähler: 17 12 1 0 0 0 0 0 0 0
 Innenezehner: 12
 Weitest: 515 (15.), 496 (19.), 457 (27.)
 beste Teiler: 27.0 (30.), 49.0 (2.), 121.4 (6.)
 Trefferkreis: 13.69 mm
 Trefferlage: 0.19 mm rechts, 0.01 mm hoch

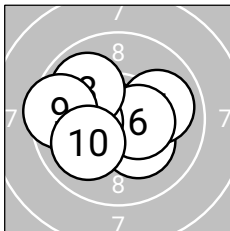
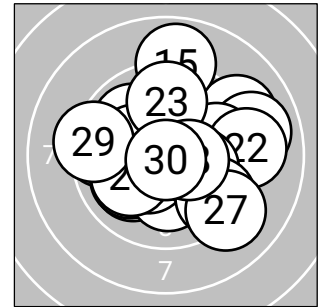

Serie 1: 101.1 (97)

10.2*↘	10.8*←	10.2*←	9.8←	10.0→
10.5*→	10.2*←	9.9↘	9.5←	10.0←

beste Teiler: 49.0 (2.), 121.4 (6.), 181.1 (3.)
 Trefferkreis: 10.39 mm
 Trefferlage: 0.94 mm links, 0.08 mm tief

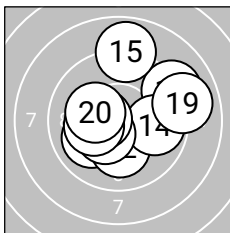

Serie 2: 98.3 (95)

10.0←	10.1↓	9.1→	9.9→	8.9↑
10.4*↘	10.5*←	10.2*←	9.0→	10.2*←

beste Teiler: 123.3 (17.), 140.0 (16.), 181.8 (20.)
 Trefferkreis: 12.24 mm
 Trefferlage: 0.44 mm rechts, 0.42 mm hoch

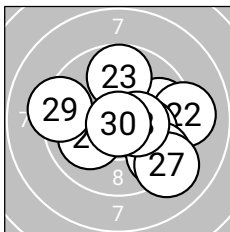

Serie 3: 98.0 (94)

9.8→	9.1→	9.8↑	10.0←	10.2*→
9.5↘	9.1↘	10.4*→	9.3←	10.8*↓

beste Teiler: 27.0 (30.), 131.7 (28.), 198.8 (25.)
 Trefferkreis: 13.19 mm
 Trefferlage: 1.06 mm rechts, 0.30 mm tief



Ergebnis: 284.3 (270)
Serien: 90.7 95.6 98.0
Zähler: 9 13 7 1 0 0 0 0 0 0 0
Innenzehner: 6
Weiteste: 754 (2.), 694 (10.), 642 (6.)
beste Teiler: 72.0 (30.), 116.0 (25.), 129.5 (24.)
Trefferkreis: 17.56 mm
Trefferlage: 0.65 mm rechts, 0.44 mm hoch

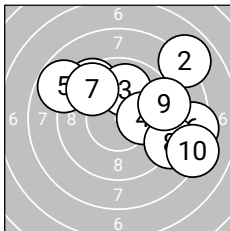
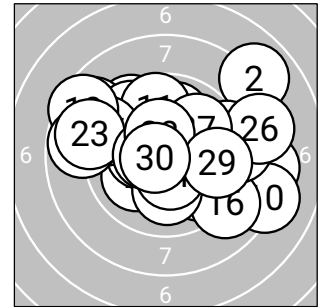

Serie 1: 90.7 (86)
 9.5 ↖ 7.9 ↗ 9.9 ↑ 10.1 → 8.8 ↖
 8.4 → 9.6 ↖ 9.0 → 9.3 → 8.2 →
beste Teiler: 211.0 (4.), 253.9 (3.), 338.0 (7.)
Trefferkreis: 16.95 mm
Trefferlage: 2.04 mm rechts, 1.14 mm hoch

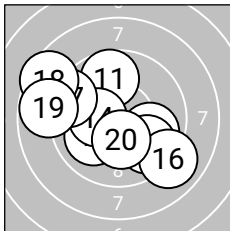

Serie 2: 95.6 (91)
 9.7 ↑ 9.9 → 10.0 ↖ 10.3* ← 9.8 ↘
 9.0 ↘ 9.3 ↖ 8.5 ↖ 8.8 ← 10.3* ↓
beste Teiler: 159.2 (14.), 163.4 (20.), 233.6 (13.)
Trefferkreis: 15.46 mm
Trefferlage: 1.00 mm links, 0.06 mm tief

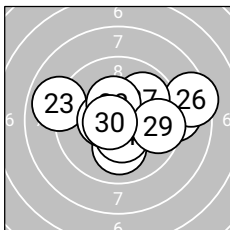

Serie 3: 98.0 (93)
 9.1 → 10.1 ↓ 8.9 ↖ 10.4* ↓ 10.5* ←
 8.4 → 9.9 ↗ 10.4* ↑ 9.6 → 10.7* ←
beste Teiler: 72.0 (30.), 116.0 (25.), 129.5 (24.)
Trefferkreis: 15.43 mm
Trefferlage: 0.92 mm rechts, 0.24 mm hoch



Ergebnis: **308.0** (293)
 Serien: 103.3 103.4 101.3
 Zähler: 23 7 0 0 0 0 0 0 0 0 0
 Innenzehner: 18
 Weitest: 372 (6.), 358 (23.), 314 (18.)
 beste Teiler: 35.8 (11.), 44.0 (7.), 53.9 (22.)
 Trefferkreis: 10.99 mm
 Trefferlage: 0.29 mm rechts, 0.18 mm tief

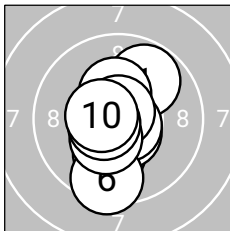
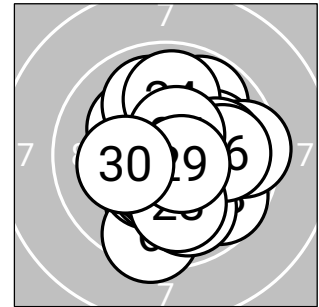

Serie 1: 103.3 (98)

9.8 ↗	10.1 ↓	10.6* ↘	10.7* ↘	10.3* ↑
9.5 ↓	10.8* ↑	10.4* ↙	10.6* ←	10.5* ←

beste Teiler: 44.0 (7.), 60.1 (4.), 93.6 (9.)
 Trefferkreis: 10.94 mm
 Trefferlage: 0.17 mm links, 0.39 mm tief

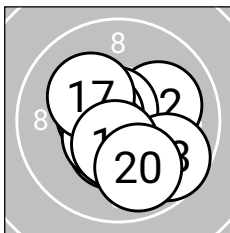

Serie 2: 103.4 (98)

10.8* ↗	10.1 →	10.7* ↖	10.6* ←	10.4* ↓
10.5* ↙	10.2* ↖	9.7 ↘	10.5* ↓	9.9 ↓

beste Teiler: 35.8 (11.), 57.0 (13.), 97.2 (14.)
 Trefferkreis: 9.52 mm
 Trefferlage: 0.21 mm rechts, 0.46 mm tief

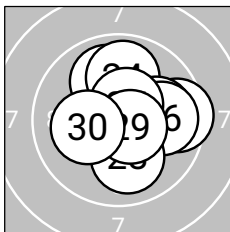

Serie 3: 101.3 (97)

10.0 ↑	10.7* ↘	9.5 →	9.9 ↑	10.0 →
9.9 →	10.5* ↗	10.0 ↓	10.6* ↘	10.2* ←

beste Teiler: 53.9 (22.), 83.7 (29.), 106.0 (27.)
 Trefferkreis: 10.01 mm
 Trefferlage: 0.83 mm rechts, 0.32 mm hoch



ISSF AR Mixed Final

StandNr: A

Exenberger, Theresa #70418117

offene Klasse

Medal Match

StartNr: 1

06.02.2026 20:02

SG_Sportschützen_Scheffau
SG Sportschützen Scheffau 1

Ergebnis: **103.8** (98)
Serien: 51.4 52.4
Zähler: 8 2 0 0 0 0 0 0 0 0
Innenzehner: 7
Weiteste: 385 (5.), 261 (10.), 223 (6.)
beste Teiler: 22.4 (8.), 34.1 (7.), 38.3 (3.)
Trefferkreis: 10.70 mm
Trefferlage: 0.30 mm links, 0.01 mm tief

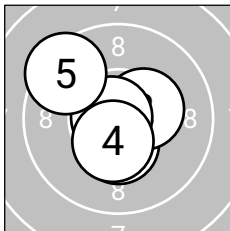
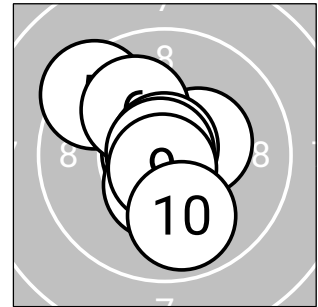

Serie 1: 51.4 (49)

10.4*↓ 10.4*↗ 10.8*← 10.4*↓ 9.4↖
beste Teiler: 38.3 (3.), 127.5 (4.), 136.0 (1.)
Trefferkreis: 9.45 mm
Trefferlage: 0.43 mm links, 0.11 mm hoch

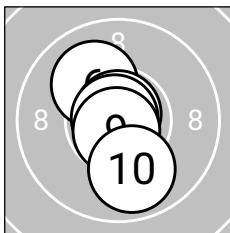

Serie 2: 52.4 (49)

10.1↖ 10.8*↑ 10.9*↖ 10.7*↓ 9.9↓
beste Teiler: 22.4 (8.), 34.1 (7.), 54.9 (9.)
Trefferkreis: 9.30 mm
Trefferlage: 0.17 mm links, 0.14 mm tief

Ergebnis: **308.7** (294)
 Serien: 102.9 103.3 102.5
 Zähler: 24 6 0 0 0 0 0 0 0 0 0
 Innenzehner: 20
 Weitestе: 390 (11.), 312 (22.), 301 (17.)
 beste Teiler: 24.8 (18.), 44.2 (3.), 48.7 (25.)
 Trefferkreis: 10.45 mm
 Trefferlage: 0.42 mm rechts, 0.43 mm tief

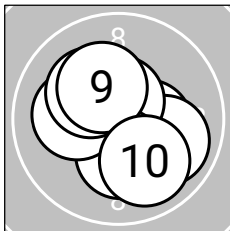
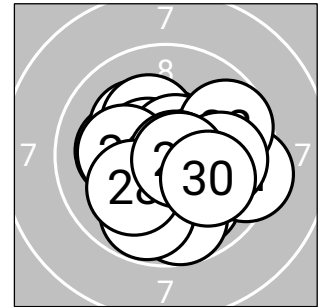

Serie 1: 102.9 (99)

10.4*→	10.3*↘	10.8*←	9.9↘	10.6*↑
10.3*↓	10.1←	10.2*↖	10.3*↖	10.0↘

beste Teiler: 44.2 (3.), 89.0 (5.), 146.1 (1.)
 Trefferkreis: 9.02 mm
 Trefferlage: 0.19 mm rechts, 0.23 mm tief

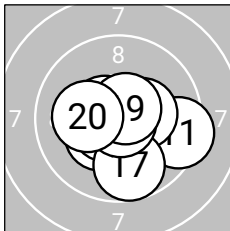

Serie 2: 103.3 (98)

9.4→	10.3*↖	10.7*↘	10.6*↖	10.3*→
10.6*↖	9.7↓	10.9*↘	10.6*↗	10.2*←

beste Teiler: 24.8 (18.), 60.4 (13.), 77.2 (19.)
 Trefferkreis: 10.33 mm
 Trefferlage: 0.24 mm rechts, 0.43 mm tief

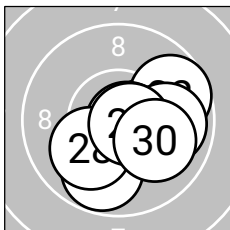

Serie 3: 102.5 (97)

10.4*→	9.7→	9.9→	10.6*↘	10.8*→
10.5*↓	9.8↓	10.1←	10.7*→	10.0↘

beste Teiler: 48.7 (25.), 66.7 (29.), 81.0 (24.)
 Trefferkreis: 9.97 mm
 Trefferlage: 0.84 mm rechts, 0.64 mm tief



ISSF AR Mixed Final**offene Klasse****StartNr: 2**

StandNr: B

Medal Match

06.02.2026 20:02

Szentannai-Güney, Marcel #70418028SG_Sportschützen_Scheffau
SG Sportschützen Scheffau 1

Ergebnis: **103.0** (98)
 Serien: 52.1 50.9
 Zähler: 8 2 0 0 0 0 0 0 0 0
 Innezzehner: 6
 Weitest: 354 (2.), 321 (6.), 244 (8.)
 beste Teiler: 48.5 (1.), 51.0 (7.), 53.2 (5.)
 Trefferkreis: 9.07 mm
 Trefferlage: 1.01 mm links, 0.25 mm tief

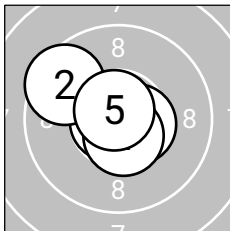
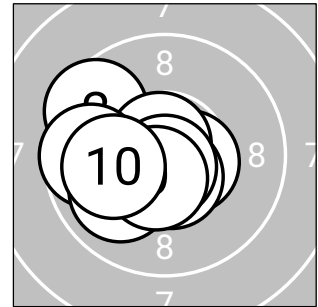
**Serie 1: 52.1** (49)

10.8*←

9.5↖

10.5*→

10.6*↓

10.7*↗

beste Teiler: 48.5 (1.), 53.2 (5.), 98.3 (4.)

Trefferkreis: 9.05 mm

Trefferlage: 0.48 mm links, 0.20 mm hoch

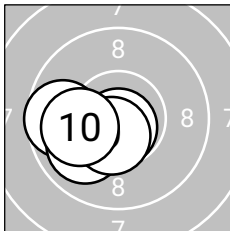
**Serie 2: 50.9** (49)

9.7←

10.7*↓

10.0↙

10.5*↘

10.0←

beste Teiler: 51.0 (7.), 107.3 (9.), 228.5 (10.)

Trefferkreis: 7.75 mm

Trefferlage: 1.55 mm links, 0.71 mm tief

Ergebnis: **291.9** (279)
 Serien: 95.8 97.0 99.1
 Zähler: 15 11 2 2 0 0 0 0 0 0
 Innenzehner: 10
 Weitestе: 828 (11.), 822 (5.), 608 (13.)
 beste Teiler: 67.1 (7.), 68.4 (9.), 152.0 (22.)
 Trefferkreis: 20.44 mm
 Trefferlage: 0.11 mm rechts, 0.25 mm hoch

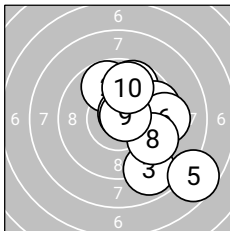
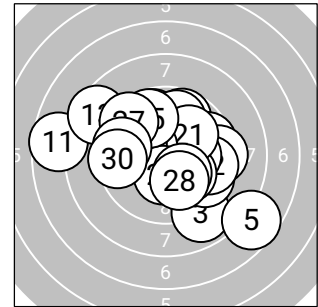

Serie 1: 95.8 (89)

9.7 ↗ 9.8 ↗ 8.9 ↘ 9.6 → 7.7 ↘
 9.3 → 10.7* ↗ 9.6 ↘ 10.7* → 9.8 ↗
 beste Teiler: 67.1 (7.), 68.4 (9.), 284.3 (10.)
 Trefferkreis: 15.33 mm
 Trefferlage: 2.15 mm rechts, 0.08 mm tief

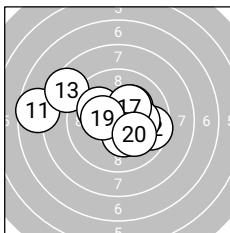

Serie 2: 97.0 (94)

7.6 ← 9.6 → 8.5 ↖ 10.0 ↖ 10.2* ↗
 10.2* → 10.2* ↗ 10.3* ↘ 10.3* ← 10.1 ↘
 beste Teiler: 155.6 (18.), 162.2 (19.), 178.5 (17.)
 Trefferkreis: 16.17 mm
 Trefferlage: 0.71 mm links, 0.46 mm hoch

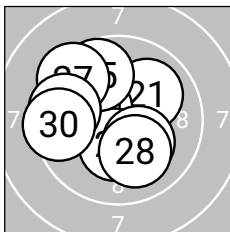

Serie 3: 99.1 (96)

10.0 ↗ 10.3* ↖ 10.0 ↖ 10.3* ↓ 9.7 ↗
 10.2* ↘ 9.4 ↖ 10.1 ↘ 9.6 ← 9.5 ←
 beste Teiler: 152.0 (22.), 154.5 (24.), 186.1 (26.)
 Trefferkreis: 10.43 mm
 Trefferlage: 1.08 mm links, 0.40 mm hoch

Ergebnis: 291.9 (281)
Serien: 96.6 99.8 95.5
Zähler: 16 9 5 0 0 0 0 0 0 0
Innenzehner: 9
Weiteste: 711 (4.), 673 (29.), 604 (28.)
beste Teiler: 65.3 (11.), 95.5 (22.), 120.4 (25.)
Trefferkreis: 17.80 mm
Trefferlage: 0.84 mm rechts, 0.26 mm tief

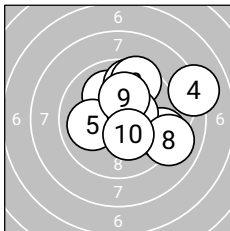
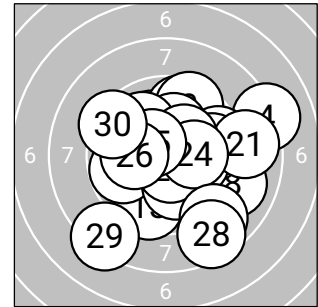

Serie 1: 96.6 (94)
 10.1 ↗ 9.7 ↗ 9.5 ↗ 8.1 → 10.0 ←
 9.3 → 10.4* → 9.0 → 10.2* ↗ 10.3* ↘
beste Teiler: 135.0 (7.), 164.2 (10.), 194.0 (9.)
Trefferkreis: 13.94 mm
Trefferlage: 1.68 mm rechts, 0.81 mm hoch

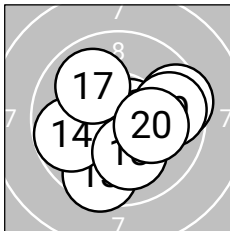

Serie 2: 99.8 (96)
 10.7* → 10.1 ↙ 9.5 ↘ 9.8 ← 9.5 →
 10.3* → 10.0 ↙ 10.1 ↘ 9.7 → 10.1 →
beste Teiler: 65.3 (11.), 161.9 (16.), 202.4 (20.)
Trefferkreis: 11.14 mm
Trefferlage: 0.43 mm rechts, 0.50 mm tief

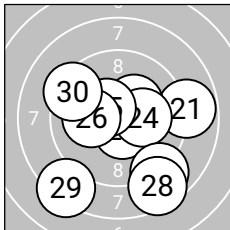

Serie 3: 95.5 (91)
 8.8 → 10.6* ↘ 10.3* ↗ 10.2* → 10.5* ↙
 10.1 ← 8.9 ↘ 8.5 ↘ 8.3 ↙ 9.3 ↙
beste Teiler: 95.5 (22.), 120.4 (25.), 164.2 (23.)
Trefferkreis: 15.67 mm
Trefferlage: 0.43 mm rechts, 1.09 mm tief



Ergebnis: **301.0** (290)
 Serien: 97.5 101.4 102.1
 Zähler: 20 10 0 0 0 0 0 0 0 0
 Innenezehner: 13
 Weitestе: 496 (1.), 450 (7.), 397 (21.)
 beste Teiler: 28.6 (29.), 38.2 (16.), 106.0 (28.)
 Trefferkreis: 12.89 mm
 Trefferlage: 0.43 mm links, 0.50 mm hoch

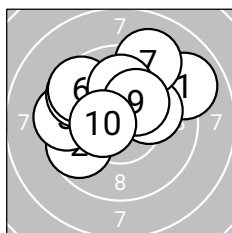
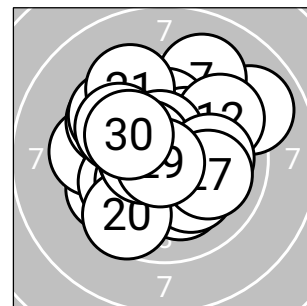

Serie 1: 97.5 (94)

9.0 ↗ 9.7 ↙ 9.5 ← 9.6 ↘ 10.1 →
 9.6 ↘ 9.2 ↗ 10.0 ↑ 10.3* ↗ 10.5* ←

beste Teiler: 118.1 (10.), 174.8 (9.), 212.8 (5.)
 Trefferkreis: 12.72 mm
 Trefferlage: 0.37 mm links, 1.41 mm hoch

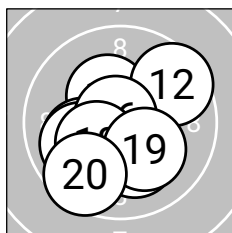

Serie 2: 101.4 (98)

10.3* ↗ 9.6 ↗ 10.1 ← 10.0 ← 10.2* ↓
 10.8* ↘ 10.3* ↘ 10.3* ↘ 10.2* ↘ 9.6 ↘

beste Teiler: 38.2 (16.), 159.6 (11.), 166.6 (17.)
 Trefferkreis: 11.28 mm
 Trefferlage: 0.44 mm links, 0.68 mm tief

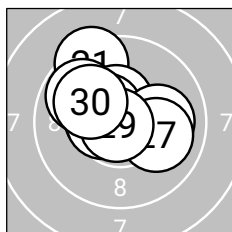

Serie 3: 102.1 (98)

9.4 ↗ 9.8 ↙ 10.5* ↑ 10.5* ↘ 10.0 →
 10.5* ← 10.0 → 10.5* ← 10.8* ↘ 10.1 ↘

beste Teiler: 28.6 (29.), 106.0 (28.), 115.8 (24.)
 Trefferkreis: 10.37 mm
 Trefferlage: 0.50 mm links, 0.76 mm hoch

ISSF AR Mixed Final

StandNr: C

Entner, Amita #70404034

offene Klasse

Medal Match

StartNr: 3

06.02.2026 20:02

SG_Wörgl

SG Wörgl 1

Ergebnis: **96.2 (91)**
Serien: 48.6 47.6
Zähler: 2 7 1 0 0 0 0 0 0 0
Innenzehner: 1
Weiteste: 529 (6.), 421 (10.), 403 (4.)
beste Teiler: 151.3 (8.), 223.2 (2.), 295.0 (1.)
Trefferkreis: 13.98 mm
Trefferlage: 0.48 mm rechts, 0.54 mm tief

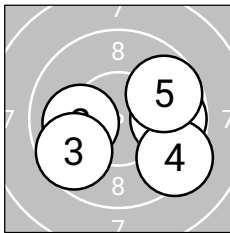
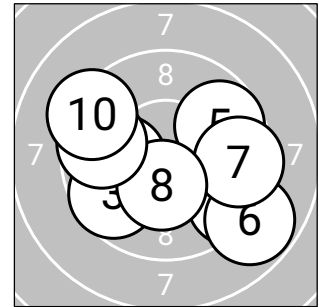

Serie 1: 48.6 (46)

9.8➔

10.1←

9.7↙

9.3➤

9.7↗

beste Teiler: 223.2 (2.), 295.0 (1.), 306.5 (5.)

Trefferkreis: 10.96 mm

Trefferlage: 0.82 mm rechts, 0.59 mm tief

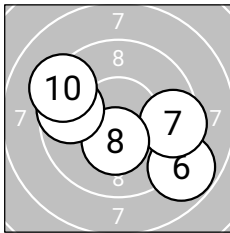

Serie 2: 47.6 (45)

8.8➤

9.5➔

10.3*↓

9.7←

9.3↙

beste Teiler: 151.3 (8.), 325.5 (9.), 366.5 (7.)

Trefferkreis: 13.98 mm

Trefferlage: 0.15 mm rechts, 0.48 mm tief

Ergebnis: 295.3 (283)
Serien: 98.7 99.3 97.3
Zähler: 15 14 0 1 0 0 0 0 0 0 0
Innenzehner: 11
Weiteste: 789 (30.), 496 (16.), 491 (2.)
beste Teiler: 2.8 (12.), 24.1 (9.), 67.1 (28.)
Trefferkreis: 15.51 mm
Trefferlage: 1.41 mm links, 0.10 mm tief

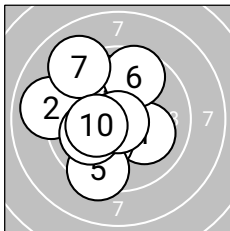
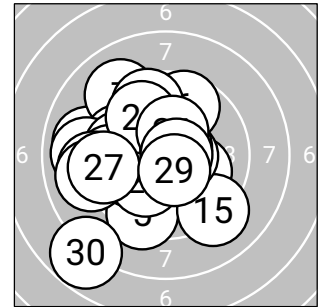

Serie 1: 98.7 (96)
 10.1 ↘ 9.0 ← 10.2* ↘ 10.0 ↑ 9.4 ↘
 9.7 ↗ 9.1 ↘ 10.0 ← 10.9* ↓ 10.3* ←
beste Teiler: 24.1 (9.), 165.4 (10.), 198.6 (3.)
Trefferkreis: 12.17 mm
Trefferlage: 1.13 mm links, 0.18 mm hoch

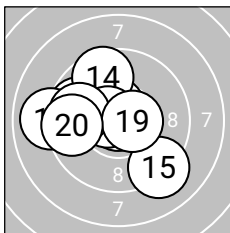

Serie 2: 99.3 (94)
 9.7 ← 10.9* ↖ 10.5* ↖ 9.6 ↖ 9.1 ↘
 9.0 ← 10.6* ← 9.8 ← 10.5* → 9.6 ←
beste Teiler: 2.8 (12.), 81.2 (17.), 101.1 (13.)
Trefferkreis: 13.24 mm
Trefferlage: 1.23 mm links, 0.21 mm hoch

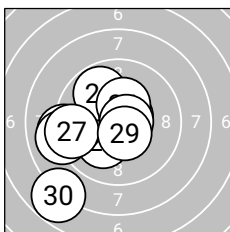

Serie 3: 97.3 (93)
 10.1 ↘ 9.1 ← 9.0 ← 9.8 ↖ 10.6* ↗
 10.3* ↗ 9.4 ← 10.7* → 10.5* ↘ 7.8 ↘
beste Teiler: 67.1 (28.), 80.2 (25.), 107.9 (29.)
Trefferkreis: 13.83 mm
Trefferlage: 1.85 mm links, 0.70 mm tief



ISSF AR Mixed Final

StandNr: D

Simbeni, Matteo #80001356

offene Klasse

Medal Match

StartNr: 4

06.02.2026 20:01

SG_Wörgl

SG Wörgl 1

Ergebnis: **99.5 (96)**
Serien: 48.9 50.6
Zähler: 7 2 1 0 0 0 0 0 0 0
Innenzehner: 4
Weiteste: 648 (1.), 365 (8.), 363 (3.)
beste Teiler: 68.0 (9.), 114.0 (5.), 118.4 (2.)
Trefferkreis: 14.41 mm
Trefferlage: 0.50 mm links, 0.15 mm tief

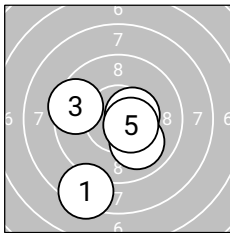
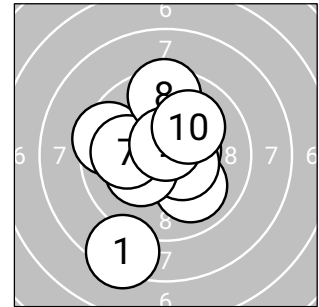

Serie 1: 48.9 (47)

8.4 ↙

10.5* →

9.5 ←

10.0 ↘

10.5* ↘

beste Teiler: 114.0 (5.), 118.4 (2.), 240.9 (4.)

Trefferkreis: 12.07 mm

Trefferlage: 0.49 mm links, 1.39 mm tief

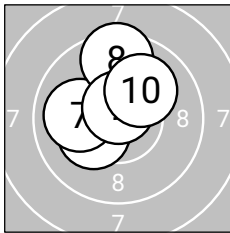

Serie 2: 50.6 (49)

10.3* ↙

10.0 ←

9.5 ↑

10.7* ↑

10.1 ↗

beste Teiler: 68.0 (9.), 175.6 (6.), 221.9 (10.)

Trefferkreis: 9.25 mm

Trefferlage: 0.51 mm links, 1.07 mm hoch