

# LG Mixed Finale

# Hobby

# StartNr: 5

StandNr: B

Medaillenvergabe

07.02.2025 19:19

Felderer, Maria-Luise #70404042

SG\_Breitenbach / SG Breitenbach 1

Ergebnis: **315 + 99.1**  
Serien: 48.4 50.7  
Zähler: 5 5 0 0 0 0 0 0 0 0  
Innenzehner: 2  
Weiteste: 405 (5.), 382 (1.), 307 (3.)  
beste Teiler: 139.7 (6.), 171.9 (9.), 207.4 (8.)  
Trefferlage: 0.94 mm links, 1.28 mm hoch  
Streuwert: 1.62, horizontal: 2.05, vertikal: 1.04

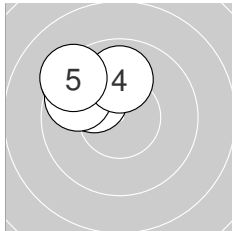
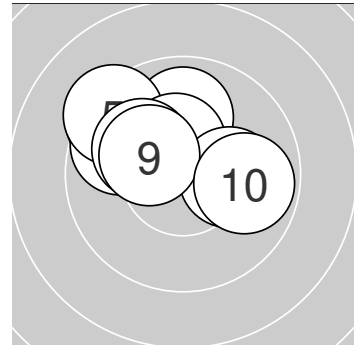

### Serie 1: 48.4 (46)

9.4 ↘      10.1 ↘      9.7 ↘      9.9 ↑      9.3 ↘  
beste Teiler: 208.6 (2.), 253.0 (4.), 307.7 (3.)  
Trefferlage: 2.11 mm links, 2.01 mm hoch  
Streuwert: 1.04, horizontal: 1.30, vertikal: 0.69

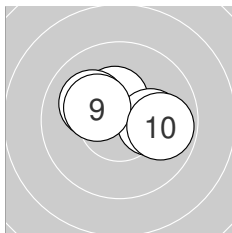

### Serie 2: 50.7 (49)

10.4\* ↑      10.1 ↘      10.1 →      10.3\* ↘      9.8 →  
beste Teiler: 139.7 (6.), 171.9 (9.), 207.4 (8.)  
Trefferlage: 0.23 mm rechts, 0.55 mm hoch  
Streuwert: 1.57, horizontal: 2.07, vertikal: 0.78



# LG Mixed Finale

# Hobby

# StartNr: 6

StandNr: C

Medaillenvergabe

07.02.2025 19:19

Felderer, Raimund #70404027

SG\_Breitenbach / SG Breitenbach 1

Ergebnis: **314 + 104.0**  
Serien: 51.5 52.5  
Zähler: 9 1 0 0 0 0 0 0 0 0  
Innenzehner: 8  
Weiteste: 267 (1.), 217 (7.), 198 (6.)  
beste Teiler: 29.8 (10.), 34.4 (8.), 73.4 (4.)  
Trefferlage: 0.77 mm links, 0.06 mm hoch  
Streuwert: 1.04, horizontal: 1.16, vertikal: 0.89

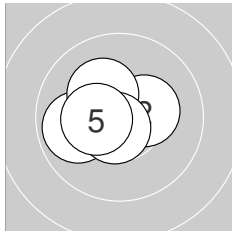
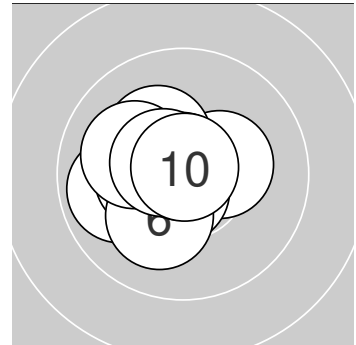

### Serie 1: 51.5 (49)

9.9 ←      10.3\* →      10.2\* ↘      10.7\* ↓      10.4\* ←  
beste Teiler: 73.4 (4.), 144.5 (5.), 158.1 (2.)  
Trefferlage: 0.77 mm links, 0.08 mm hoch  
Streuwert: 1.25, horizontal: 1.53, vertikal: 0.88

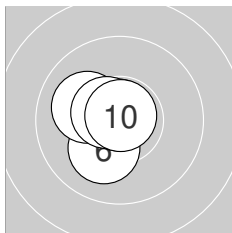

### Serie 2: 52.5 (50)

10.2\* ↓      10.1 ↙      10.8\* ↑      10.6\* ↘      10.8\* ↑  
beste Teiler: 29.8 (10.), 34.4 (8.), 94.1 (9.)  
Trefferlage: 0.76 mm links, 0.03 mm hoch  
Streuwert: 0.92, horizontal: 0.83, vertikal: 1.01



# LG Mixed Finale

# Hobby

# StartNr: 7

StandNr: F

Medaillenvergabe

07.02.2025 19:19

AchRAINER, Ursula #70402080

SG\_Bad-Häring / SG Bad-Häring 1

Ergebnis: **308 + 98.2**  
Serien: 47.7 50.5  
Zähler: 6 3 1 0 0 0 0 0 0 0  
Innenzehner: 3  
Weiteste: 734 (3.), 383 (2.), 313 (4.)  
beste Teiler: 103.5 (1.), 152.9 (6.), 181.2 (10.)  
Trefferlage: 1.46 mm links, 0.53 mm hoch  
Streuwert: 2.14, horizontal: 2.62, vertikal: 1.52

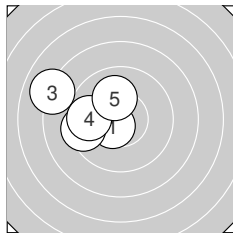
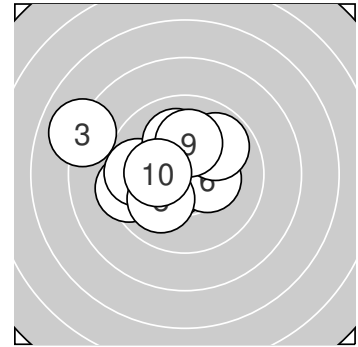

### Serie 1: 47.7 (46)

10.5\* ↙                      9.4 ←                      8.0 ↖                      9.7 ←                      10.1 ↑  
beste Teiler: 103.5 (1.), 219.0 (5.), 313.1 (4.)  
Trefferlage: 3.00 mm links, 0.67 mm hoch  
Streuwert: 2.15, horizontal: 2.54, vertikal: 1.67

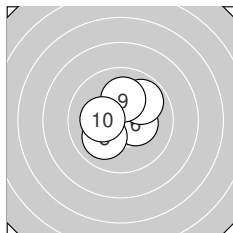

### Serie 2: 50.5 (49)

10.3\* →                      9.9 ↗                      10.0 ↘                      10.1 ↑                      10.2\* ←  
beste Teiler: 152.9 (6.), 181.2 (10.), 207.5 (9.)  
Trefferlage: 0.07 mm rechts, 0.40 mm hoch  
Streuwert: 1.65, horizontal: 1.75, vertikal: 1.55



# LG Mixed Finale

# Hobby

# StartNr: 8

StandNr: G

Medaillenvergabe

07.02.2025 19:19

Koller, Horst #70402010

SG\_Bad-Häring / SG Bad-Häring 1

Ergebnis: **315 + 100.0**  
Serien: 50.2 49.8  
Zähler: 7 3 0 0 0 0 0 0 0 0 0  
Innenzehner: 2  
Weiteste: 364 (1.), 294 (7.), 266 (6.)  
beste Teiler: 142.6 (2.), 193.3 (3.), 213.0 (4.)  
Trefferlage: 1.74 mm rechts, 0.25 mm hoch  
Streuwert: 1.29, horizontal: 1.60, vertikal: 0.87

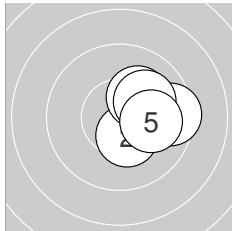
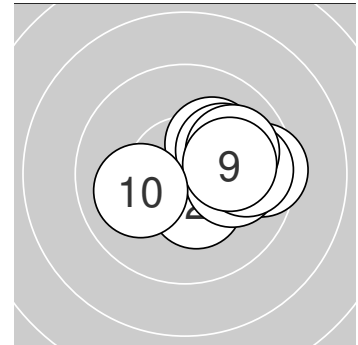

### Serie 1: 50.2 (49)

9.5 →      10.4\* ↓      10.2\* ↗  
beste Teiler: 142.6 (2.), 193.3 (3.), 213.0 (4.)  
Trefferlage: 1.90 mm rechts, 0.23 mm hoch  
Streuwert: 1.14, horizontal: 1.16, vertikal: 1.11

10.1 ↗      10.0 →

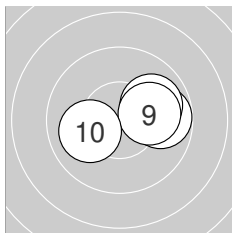

### Serie 2: 49.8 (48)

9.9 →      9.8 →      10.0 →  
beste Teiler: 219.1 (9.), 226.2 (10.), 250.9 (8.)  
Trefferlage: 1.57 mm rechts, 0.26 mm hoch  
Streuwert: 1.55, horizontal: 2.09, vertikal: 0.67

10.1 →      10.0 ←



# LG Mixed Finale

# Hobby

StartNr: 1

StandNr: B

Medaillenvergabe

07.02.2025 19:21

Achleitner, Brigitte #70412120

SG\_Kundl / SG Kundl 2

Ergebnis: **308 + 123.1**  
Serien: 50.8 51.5 20.8  
Zähler: 10 2 0 0 0 0 0 0 0 0  
Innenzehner: 9  
Weiteste: 271 (7.), 260 (2.), 223 (3.)  
beste Teiler: 55.6 (8.), 126.3 (12.), 139.6 (11.)  
Trefferlage: 0.90 mm rechts, 1.32 mm hoch  
Streuwert: 0.63, horizontal: 0.55, vertikal: 0.71

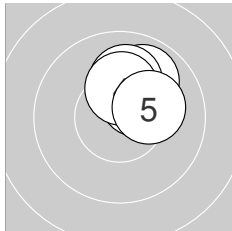
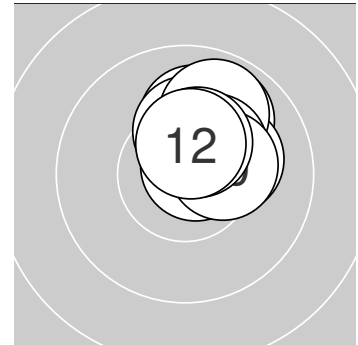

### Serie 1: 50.8 (49)

10.4\* ↗ 9.9 ↗ 10.1 ↑ 10.2\* ↑ 10.2\* →  
beste Teiler: 149.9 (1.), 176.4 (4.), 189.1 (5.)  
Trefferlage: 0.94 mm rechts, 1.56 mm hoch  
Streuwert: 0.70, horizontal: 0.70, vertikal: 0.71

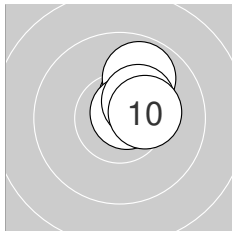

### Serie 2: 51.5 (49)

10.3\* ↗ 9.9 ↗ 10.7\* ↗ 10.3\* ↗ 10.3\* →  
beste Teiler: 55.6 (8.), 154.3 (9.), 159.3 (10.)  
Trefferlage: 1.06 mm rechts, 1.10 mm hoch  
Streuwert: 0.67, horizontal: 0.40, vertikal: 0.86

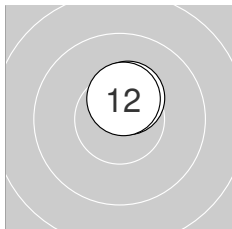

### Serie 3: 20.8 (20)

10.4\* ↑ 10.4\* ↑  
beste Teiler: 126.3 (12.), 139.6 (11.)  
Trefferlage: 0.37 mm rechts, 1.27 mm hoch  
Streuwert: 0.14, horizontal: 0.19, vertikal: 0.04



# LG Mixed Finale

# Hobby

# StartNr: 2

StandNr: C

Medaillenvergabe

07.02.2025 19:21

Thaler, Günther #70412084

SG\_Kundl / SG Kundl 2

Ergebnis: **315 + 124.9**  
 Serien: 52.3 52.0 20.6  
 Zähler: 11 1 0 0 0 0 0 0 0 0  
 Innenzehner: 10  
 Weitest: 322 (6.), 230 (12.), 180 (3.)  
 beste Teiler: 30.5 (10.), 57.8 (1.), 85.6 (11.)  
 Trefferlage: 0.61 mm rechts, 0.02 mm tief  
 Streuwert: 1.06, horizontal: 1.24, vertikal: 0.84

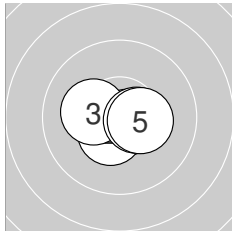
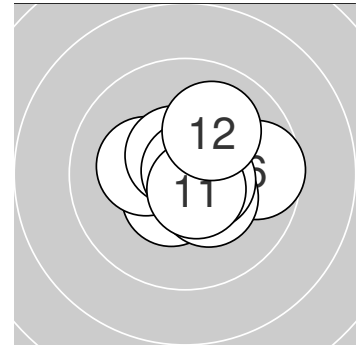
**Serie 1: 52.3 (50)**

10.7\* ↘      10.5\* ↙      10.2\* ←      10.5\* →      10.4\* →  
 beste Teiler: 57.8 (1.), 115.7 (4.), 120.2 (2.)  
 Trefferlage: 0.12 mm rechts, 0.29 mm tief  
 Streuwert: 1.00, horizontal: 1.32, vertikal: 0.50

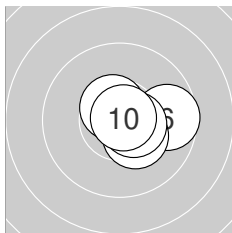
**Serie 2: 52.0 (49)**

9.7 →      10.3\* ↘      10.6\* ↘      10.6\* →      10.8\* ↗  
 beste Teiler: 30.5 (10.), 97.1 (8.), 100.2 (9.)  
 Trefferlage: 1.01 mm rechts, 0.03 mm tief  
 Streuwert: 1.10, horizontal: 1.38, vertikal: 0.70

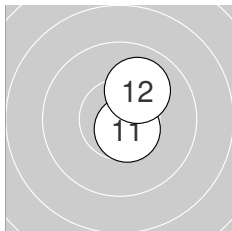
**Serie 3: 20.6 (20)**

10.6\* ↘      10.0 ↗  
 beste Teiler: 85.6 (11.), 230.3 (12.)  
 Trefferlage: 0.86 mm rechts, 0.64 mm hoch  
 Streuwert: 1.36, horizontal: 0.49, vertikal: 1.87



# LG Mixed Finale

# Hobby

# StartNr: 3

StandNr: F

Medaillenvergabe

07.02.2025 19:21

Németh, Franciska #80001210

SG\_Kundl / SG Kundl 4

Ergebnis: **311 + 121.4**  
Serien: 53.6 47.9 19.9  
Zähler: 9 1 2 0 0 0 0 0 0 0  
Innenzehner: 8  
Weiteste: 695 (9.), 584 (6.), 280 (11.)  
beste Teiler: 25.0 (5.), 34.4 (3.), 66.1 (2.)  
Trefferlage: 1.52 mm links, 0.70 mm tief  
Streuwert: 1.80, horizontal: 2.42, vertikal: 0.77

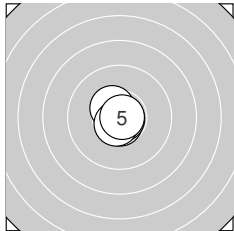
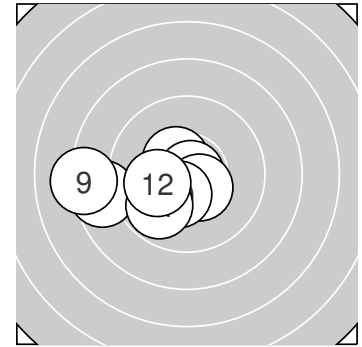
**Serie 1: 53.6 (50)**

10.5\* ↘      10.7\* ↓      10.8\* ↘      10.7\* ↙      10.9\* →  
beste Teiler: 25.0 (5.), 34.4 (3.), 66.1 (2.)  
Trefferlage: 0.10 mm links, 0.11 mm tief  
Streuwert: 0.56, horizontal: 0.44, vertikal: 0.66

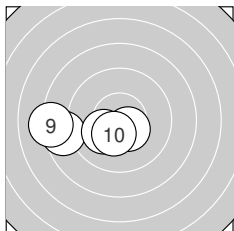
**Serie 2: 47.9 (46)**

8.6 ←      10.5\* ↘      10.2\* ↙      8.2 ←      10.4\* ↙  
beste Teiler: 123.1 (7.), 147.8 (10.), 197.6 (8.)  
Trefferlage: 2.79 mm links, 1.04 mm tief  
Streuwert: 2.39, horizontal: 3.36, vertikal: 0.37

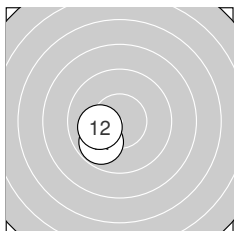
**Serie 3: 19.9 (19)**

9.8 ↙      10.1 ←  
beste Teiler: 207.8 (12.), 280.5 (11.)  
Trefferlage: 1.92 mm links, 1.35 mm tief  
Streuwert: 0.75, horizontal: 0.09, vertikal: 1.06



# LG Mixed Finale

# Hobby

StartNr: 4

StandNr: G

Medaillenvergabe

07.02.2025 19:21

Entner, Reinhard #70412085

SG\_Kundl / SG Kundl 4

Ergebnis: **313 + 123.7**  
Serien: 51.1 52.7 19.9  
Zähler: 10 2 0 0 0 0 0 0 0 0  
Innenzehner: 9  
Weiteste: 374 (12.), 310 (4.), 211 (2.)  
beste Teiler: 41.1 (6.), 91.2 (8.), 99.5 (5.)  
Trefferlage: 1.40 mm rechts, 0.43 mm tief  
Streuwert: 0.87, horizontal: 1.01, vertikal: 0.70

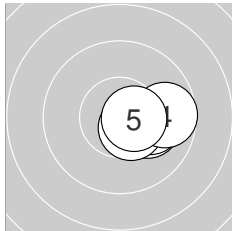
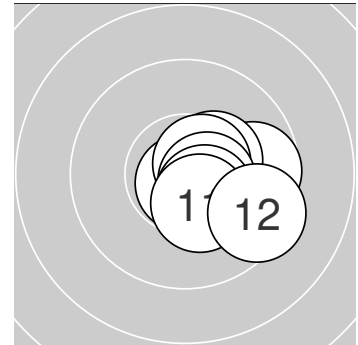

### Serie 1: 51.1 (49)

10.2\* → 10.1 → 10.5\* ↘ 9.7 → 10.6\* →  
beste Teiler: 99.5 (5.), 106.1 (3.), 200.2 (1.)  
Trefferlage: 1.77 mm rechts, 0.31 mm tief  
Streuwert: 0.70, horizontal: 0.93, vertikal: 0.35

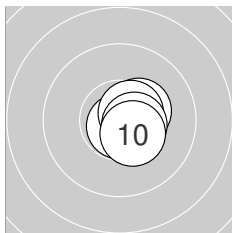

### Serie 2: 52.7 (50)

10.8\* ↓ 10.4\* ↗ 10.6\* ↗ 10.5\* → 10.4\* ↘  
beste Teiler: 41.1 (6.), 91.2 (8.), 105.9 (9.)  
Trefferlage: 0.79 mm rechts, 0.10 mm tief  
Streuwert: 0.58, horizontal: 0.50, vertikal: 0.65

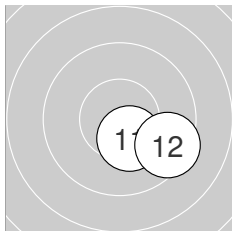

### Serie 3: 19.9 (19)

10.4\* ↘ 9.5 ↘  
beste Teiler: 149.3 (11.), 374.0 (12.)  
Trefferlage: 1.98 mm rechts, 1.55 mm tief  
Streuwert: 1.32, horizontal: 1.85, vertikal: 0.32





**Ergebnis: 315.3 (298)**  
**Serien: 104.8 104.9 105.6**  
**Zähler: 28 2 0 0 0 0 0 0 0 0 0**  
**Innenzehner: 26**  
**Weiteste: 316 (30.), 267 (14.), 242 (17.)**  
**beste Teiler: 3.0 (8.), 14.1 (22.), 33.0 (25.)**  
**Trefferlage: 0.17 mm rechts, 0.03 mm tief**  
**Streuwert: 0.96, horizontal: 1.12, vertikal: 0.76**

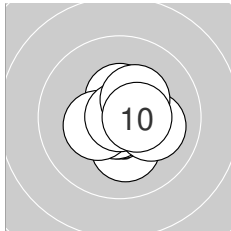
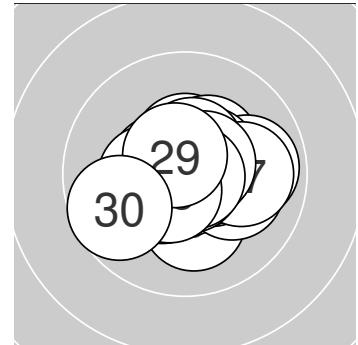

**Serie 1: 104.8 (100)**

10.5* ↑	10.3* ↓	10.2* ↓	10.8* ↓	10.7* ↙
10.1 →	10.4* ↖	10.9* ↑	10.4* ↗	10.5* →

**beste Teiler: 3.0 (8.), 44.0 (4.), 51.1 (5.)**  
**Trefferlage: 0.33 mm rechts, 0.29 mm tief**  
**Streuwert: 0.95, horizontal: 0.92, vertikal: 0.99**

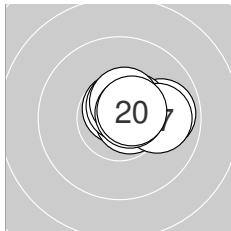

**Serie 2: 104.9 (99)**

10.7* →	10.7* ↑	10.7* →	9.9 →	10.6* ↑
10.5* ↗	10.0 →	10.5* ↑	10.7* ↗	10.6* ↗

**beste Teiler: 63.8 (11.), 64.0 (12.), 66.1 (13.)**  
**Trefferlage: 0.89 mm rechts, 0.43 mm hoch**  
**Streuwert: 0.70, horizontal: 0.93, vertikal: 0.35**

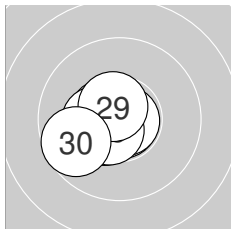

**Serie 3: 105.6 (99)**

10.5* ↖	10.9* ↘	10.5* ↙	10.4* ←	10.8* ↘
10.8* ←	10.8* →	10.6* ↙	10.6* ↖	9.7 ↙

**beste Teiler: 14.1 (22.), 33.0 (25.), 34.7 (27.)**  
**Trefferlage: 0.71 mm links, 0.23 mm tief**  
**Streuwert: 0.79, horizontal: 0.94, vertikal: 0.62**



Ergebnis: **314.3** (299)  
 Serien: 105.9 104.4 104.0  
 Zähler: 29 1 0 0 0 0 0 0 0 0 0  
 Innenzehner: 26  
 Weitester: 272 (19.), 246 (25.), 236 (15.)  
 beste Teiler: 17.8 (8.), 24.6 (24.), 35.7 (14.)  
 Trefferlage: 0.05 mm links, 0.10 mm tief  
 Streuwert: 0.99, horizontal: 1.05, vertikal: 0.93

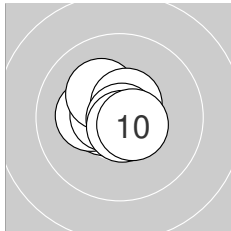
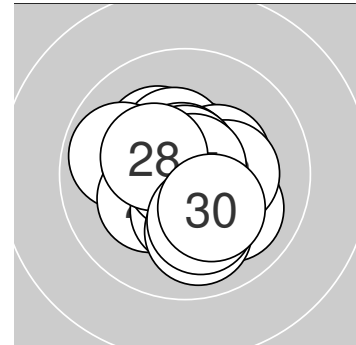

**Serie 1: 105.9 (100)**

10.7* ←	10.6* ←	10.2* ←	10.6* ←	10.2* ↖
10.8* ↘	10.6* ↗	10.9* ↘	10.7* ↓	10.6* ↘

beste Teiler: 17.8 (8.), 45.6 (6.), 59.4 (9.)  
 Trefferlage: 0.35 mm links, 0.09 mm hoch  
 Streuwert: 0.74, horizontal: 0.85, vertikal: 0.61

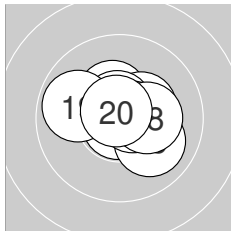

**Serie 2: 104.4 (99)**

10.4* ↖	10.4* ↗	10.5* →	10.8* ↓	10.0 ↘
10.7* ↖	10.6* →	10.3* →	9.9 ←	10.8* ↖

beste Teiler: 35.7 (14.), 49.6 (20.), 75.5 (16.)  
 Trefferlage: 0.33 mm rechts, 0.21 mm hoch  
 Streuwert: 1.10, horizontal: 1.34, vertikal: 0.78

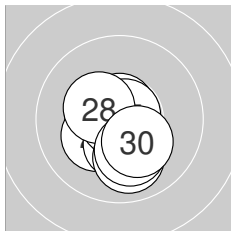

**Serie 3: 104.0 (100)**

10.4* ↖	10.2* ↖	10.3* ↓	10.9* ←	10.0 ↓
10.7* ↑	10.8* ↗	10.4* ↖	10.1 ↓	10.2* ↘

beste Teiler: 24.6 (24.), 42.5 (27.), 63.0 (26.)  
 Trefferlage: 0.15 mm links, 0.63 mm tief  
 Streuwert: 1.03, horizontal: 0.89, vertikal: 1.16



Ergebnis: **308.7** (293)  
 Serien: 104.3 104.7 99.7  
 Zähler: 23 7 0 0 0 0 0 0 0 0  
 Innenzehner: 21  
 Weitestе: 438 (28.), 375 (22.), 367 (27.)  
 beste Teiler: 22.8 (10.), 28.0 (29.), 31.1 (14.)  
 Trefferlage: 0.08 mm links, 0.04 mm tief  
 Streuwert: 1.45, horizontal: 1.77, vertikal: 1.04

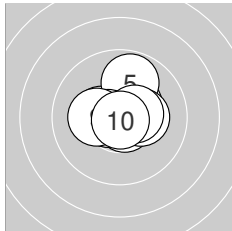
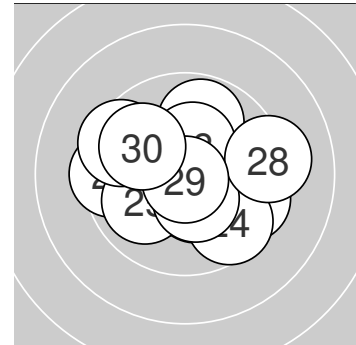

**Serie 1: 104.3 (99)**

10.4* ↗	10.5* →	10.7* ↘	10.4* ←	9.8 ↑
10.3* →	10.6* ←	10.5* →	10.2* ←	10.9* ↓

beste Teiler: 22.8 (10.), 61.0 (3.), 90.4 (7.)  
 Trefferlage: 0.20 mm rechts, 0.35 mm hoch  
 Streuwert: 1.05, horizontal: 1.19, vertikal: 0.90

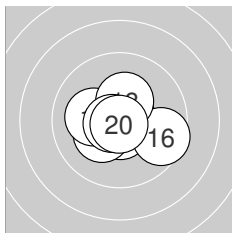

**Serie 2: 104.7 (99)**

10.8* ↗	10.6* ↓	10.3* ↖	10.8* ↖	10.7* ↗
9.6 ↘	10.1 ←	10.3* ↑	10.7* ↖	10.8* ↓

beste Teiler: 31.1 (14.), 31.4 (20.), 42.8 (11.)  
 Trefferlage: 0.02 mm rechts, 0.15 mm tief  
 Streuwert: 1.13, horizontal: 1.38, vertikal: 0.80

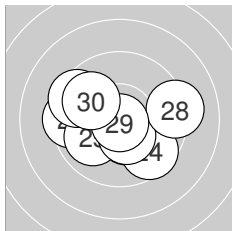

**Serie 3: 99.7 (95)**

10.4* ←	9.5 ←	10.4* ↓	9.6 ↘	10.0 ↖
10.4* ↓	9.5 ↖	9.2 →	10.8* ↓	9.9 ↖

beste Teiler: 28.0 (29.), 138.7 (26.), 138.8 (21.)  
 Trefferlage: 0.49 mm links, 0.32 mm tief  
 Streuwert: 2.02, horizontal: 2.54, vertikal: 1.32



Ergebnis: **315.8** (298)  
 Serien: 105.6 104.9 105.3  
 Zähler: 28 2 0 0 0 0 0 0 0 0  
 Innenzehner: 25  
 Weitestе: 284 (2.), 275 (23.), 232 (17.)  
 beste Teiler: 17.2 (19.), 36.0 (12.), 37.7 (10.)  
 Trefferlage: 0.37 mm rechts, 0.12 mm tief  
 Streuwert: 0.87, horizontal: 1.09, vertikal: 0.58

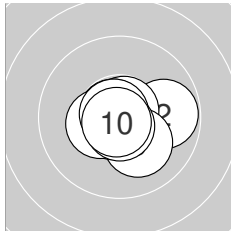
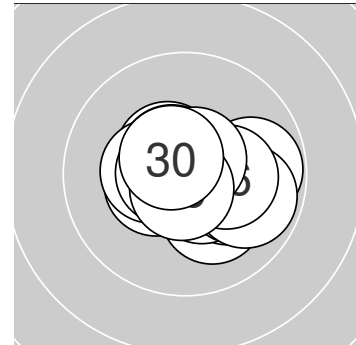

**Serie 1: 105.6 (99)**

10.7* ↘	9.8 →	10.8* ↗	10.8* ↖	10.1 ↘
10.7* ↙	10.4* ←	10.7* ↓	10.8* ↗	10.8* ↙

beste Teiler: 37.7 (10.), 42.1 (9.), 47.4 (4.)  
 Trefferlage: 0.23 mm rechts, 0.27 mm tief  
 Streuwert: 0.90, horizontal: 1.13, vertikal: 0.59

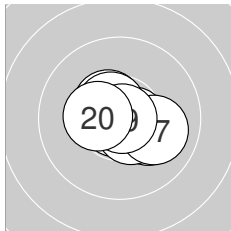

**Serie 2: 104.9 (100)**

10.5* ↖	10.8* ↙	10.6* →	10.5* ↘	10.1 ↘
10.5* ↘	10.0 →	10.6* ↖	10.9* →	10.4* ←

beste Teiler: 17.2 (19.), 36.0 (12.), 88.7 (13.)  
 Trefferlage: 0.37 mm rechts, 0.17 mm tief  
 Streuwert: 0.92, horizontal: 1.15, vertikal: 0.61

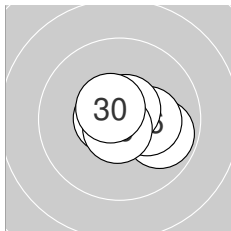

**Serie 3: 105.3 (99)**

10.4* →	10.8* ↑	9.9 →	10.7* →	10.7* ↑
10.2* →	10.7* ←	10.6* ↗	10.7* ↓	10.6* ↖

beste Teiler: 42.4 (22.), 59.0 (25.), 62.5 (29.)  
 Trefferlage: 0.52 mm rechts, 0.06 mm hoch  
 Streuwert: 0.85, horizontal: 1.08, vertikal: 0.54



Ergebnis: **308.7** (293)  
 Serien: 103.8 101.1 103.8  
 Zähler: 23 7 0 0 0 0 0 0 0 0  
 Innenzehner: 22  
 Weitesten: 371 (14.), 339 (22.), 289 (19.)  
 beste Teiler: 30.5 (1.), 39.4 (29.), 57.8 (23.)  
 Trefferlage: 0.11 mm links, 1.08 mm tief  
 Streuwert: 1.10, horizontal: 1.13, vertikal: 1.08

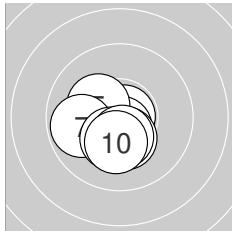
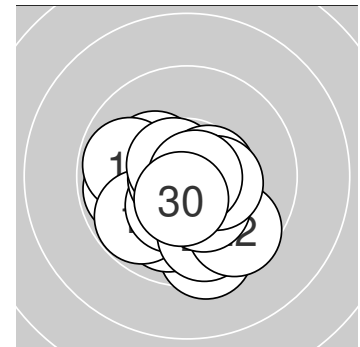

**Serie 1: 103.8 (99)**

10.8* →	10.4* ↓	10.6* ↓	10.7* ↓	10.3* ↖
10.3* ↓	9.8 ←	10.3* ↓	10.4* ↓	10.2* ↓

beste Teiler: 30.5 (1.), 74.3 (4.), 87.0 (3.)  
 Trefferlage: 0.38 mm links, 0.88 mm tief  
 Streuwert: 0.91, horizontal: 0.99, vertikal: 0.82

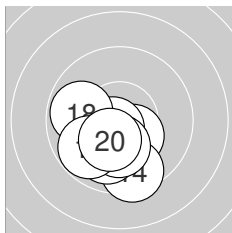

**Serie 2: 101.1 (96)**

9.9 ↓	10.4* ↘	10.5* ↙	9.5 ↓	10.7* ↗
10.0 ↙	10.2* ↓	9.8 ←	9.8 ↗	10.3* ↙

beste Teiler: 75.2 (15.), 113.7 (13.), 144.8 (12.)  
 Trefferlage: 0.55 mm links, 1.58 mm tief  
 Streuwert: 1.18, horizontal: 1.19, vertikal: 1.17

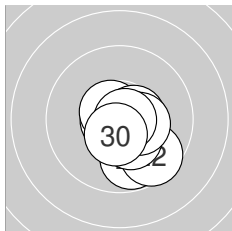

**Serie 3: 103.8 (98)**

9.8 ↓	9.6 ↘	10.7* ←	10.3* ↓	10.6* ↖
10.5* →	10.6* →	10.4* →	10.8* →	10.5* ↓

beste Teiler: 39.4 (29.), 57.8 (23.), 79.1 (27.)  
 Trefferlage: 0.59 mm rechts, 0.77 mm tief  
 Streuwert: 1.02, horizontal: 0.90, vertikal: 1.13



Ergebnis: **315.5** (299)  
 Serien: 105.5 104.7 105.3  
 Zähler: 29 1 0 0 0 0 0 0 0 0  
 Innenzehner: 26  
 Weitestе: 333 (13.), 249 (9.), 222 (6.)  
 beste Teiler: 1.0 (2.), 10.0 (16.), 16.1 (28.)  
 Trefferlage: 0.13 mm links, 0.17 mm tief  
 Streuwert: 0.97, horizontal: 0.97, vertikal: 0.97

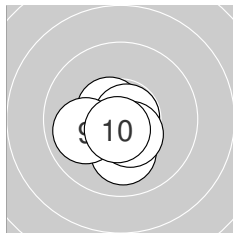
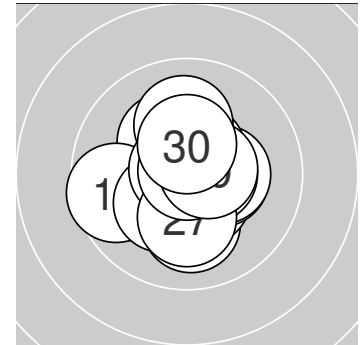

**Serie 1: 105.5 (100)**

10.9* ←	10.9* →	10.7* ←	10.3* ↓	10.6* ↘
10.1 ↓	10.8* ↗	10.5* ↘	10.0 ←	10.7* ↓

beste Teiler: 1.0 (2.), 21.0 (1.), 42.7 (7.)  
 Trefferlage: 0.29 mm links, 0.55 mm tief  
 Streuwert: 0.86, horizontal: 0.85, vertikal: 0.87

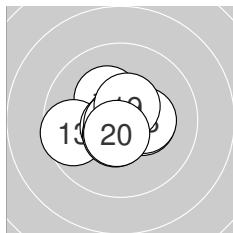

**Serie 2: 104.7 (99)**

10.3* ↘	10.4* →	9.6 ←	10.7* ↙	10.6* ↓
10.9* ←	10.8* ↗	10.3* →	10.5* ↑	10.6* ↓

beste Teiler: 10.0 (16.), 34.0 (17.), 68.0 (14.)  
 Trefferlage: 0.21 mm links, 0.10 mm tief  
 Streuwert: 1.10, horizontal: 1.34, vertikal: 0.79

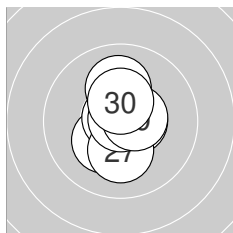

**Serie 3: 105.3 (100)**

10.6* →	10.8* ↑	10.1 ↑	10.3* ↙	10.8* ↘
10.6* →	10.2* ↓	10.9* ↑	10.6* →	10.4* ↑

beste Teiler: 16.1 (28.), 27.0 (22.), 44.7 (25.)  
 Trefferlage: 0.11 mm rechts, 0.14 mm hoch  
 Streuwert: 0.95, horizontal: 0.65, vertikal: 1.17



Ergebnis: **311.0** (296)  
 Serien: 104.1 103.7 103.2  
 Zähler: 26 4 0 0 0 0 0 0 0 0  
 Innenzehner: 24  
 Weitester: 367 (28.), 298 (16.), 295 (18.)  
 beste Teiler: 10.7 (14.), 47.5 (19.), 57.7 (1.)  
 Trefferlage: 0.30 mm links, 0.17 mm hoch  
 Streuwert: 1.19, horizontal: 1.47, vertikal: 0.83

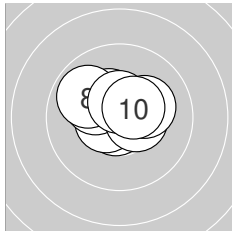
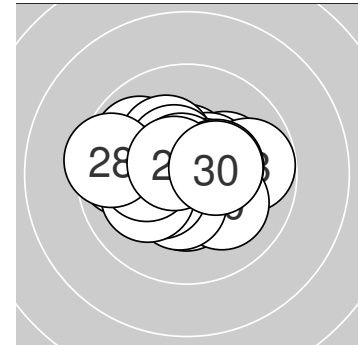

**Serie 1: 104.1 (99)**

10.7* ↙	10.4* ↖	10.6* ↑	10.6* ←	10.2* ↖
10.5* →	10.2* ↗	9.9 ↘	10.5* ↑	10.5* ↗

beste Teiler: 57.7 (1.), 90.0 (3.), 100.2 (4.)  
 Trefferlage: 0.21 mm links, 0.60 mm hoch  
 Streuwert: 1.03, horizontal: 1.28, vertikal: 0.70

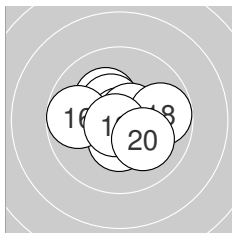

**Serie 2: 103.7 (98)**

10.2* ↖	10.5* ↖	10.6* ↘	10.9* ↑	10.4* ↓
9.8 ←	10.6* ↗	9.8 →	10.8* ↗	10.1 ↘

beste Teiler: 10.7 (14.), 47.5 (19.), 87.2 (13.)  
 Trefferlage: 0.12 mm rechts, 0.02 mm hoch  
 Streuwert: 1.31, horizontal: 1.59, vertikal: 0.94

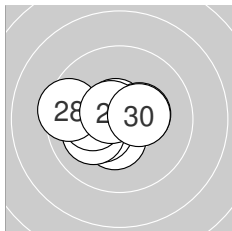

**Serie 3: 103.2 (99)**

10.7* ↖	10.6* ←	10.4* ↓	10.3* ↖	10.1 ↖
10.2* ←	10.4* →	9.5 ←	10.6* ↖	10.4* →

beste Teiler: 71.6 (21.), 79.5 (29.), 97.4 (22.)  
 Trefferlage: 0.80 mm links, 0.09 mm tief  
 Streuwert: 1.19, horizontal: 1.52, vertikal: 0.74



Ergebnis: **313.0** (300)  
 Serien: 103.8 104.2 105.0  
 Zähler: 30 0 0 0 0 0 0 0 0 0 0  
 Innenzehner: 24  
 Weitesten: 249 (29.), 241 (9.), 238 (19.)  
 beste Teiler: 40.0 (30.), 44.9 (18.), 48.0 (16.)  
 Trefferlage: 0.16 mm links, 0.10 mm tief  
 Streuwert: 1.04, horizontal: 1.18, vertikal: 0.88

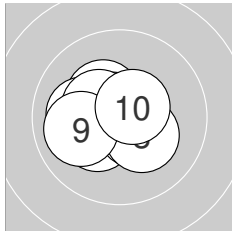
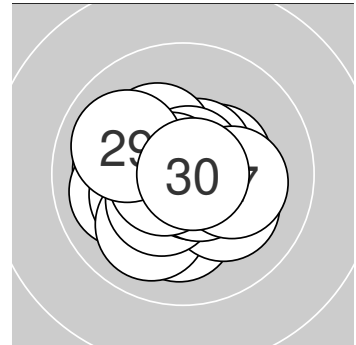

**Serie 1: 103.8 (100)**

10.6* ↗	10.3* ↘	10.7* ↘	10.1 ←	10.3* ↙
10.5* ↘	10.4* ↘	10.3* ↘	10.0 ←	10.6* ↗

beste Teiler: 62.9 (3.), 78.4 (1.), 99.6 (10.)  
 Trefferlage: 0.49 mm links, 0.01 mm hoch  
 Streuwert: 1.09, horizontal: 1.31, vertikal: 0.82

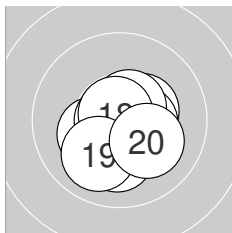

**Serie 2: 104.2 (100)**

10.4* →	10.3* ↙	10.7* ↗	10.4* →	10.6* ↗
10.8* ←	10.1 ↓	10.8* ↘	10.0 ↙	10.1 ↘

beste Teiler: 44.9 (18.), 48.0 (16.), 68.2 (13.)  
 Trefferlage: 0.16 mm rechts, 0.41 mm tief  
 Streuwert: 1.07, horizontal: 1.08, vertikal: 1.06

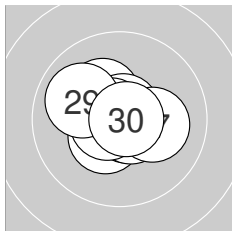

**Serie 3: 105.0 (100)**

10.4* ↙	10.3* ↘	10.7* ↗	10.7* ↘	10.7* ↘
10.6* ↘	10.2* →	10.6* ←	10.0 ↘	10.8* →

beste Teiler: 40.0 (30.), 52.3 (23.), 56.8 (24.)  
 Trefferlage: 0.16 mm links, 0.08 mm hoch  
 Streuwert: 0.97, horizontal: 1.15, vertikal: 0.74





Ergebnis: **314.0** (299)  
 Serien: 104.1 104.6 105.3  
 Zähler: 29 1 0 0 0 0 0 0 0 0  
 Innenzehner: 26  
 Weitester: 291 (16.), 219 (8.), 212 (24.)  
 beste Teiler: 22.3 (22.), 27.0 (18.), 38.9 (5.)  
 Trefferlage: 0.66 mm rechts, 0.10 mm tief  
 Streuwert: 0.86, horizontal: 0.82, vertikal: 0.90

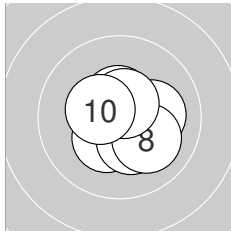
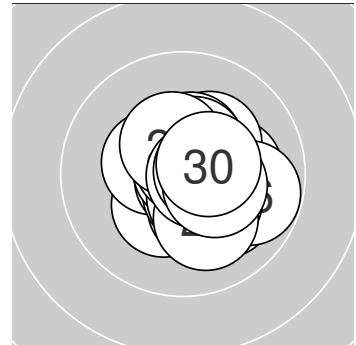

**Serie 1: 104.1 (100)**

10.5* ↑	10.3* →	10.1 →	10.7* ↓	10.8* ↗
10.3* ↘	10.3* ↓	10.1 ↘	10.6* ↑	10.4* ↖

beste Teiler: 38.9 (5.), 60.2 (4.), 92.6 (9.)  
 Trefferlage: 0.49 mm rechts, 0.17 mm tief  
 Streuwert: 1.01, horizontal: 1.09, vertikal: 0.93

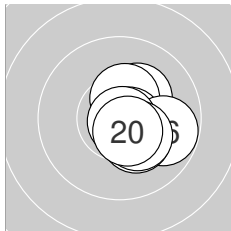

**Serie 2: 104.6 (99)**

10.8* →	10.6* →	10.3* ↗	10.4* ↑	10.7* ↘
9.8 →	10.3* ↘	10.8* ↓	10.3* ↓	10.6* ↓

beste Teiler: 27.0 (18.), 49.6 (11.), 63.6 (15.)  
 Trefferlage: 0.90 mm rechts, 0.16 mm tief  
 Streuwert: 0.83, horizontal: 0.75, vertikal: 0.91

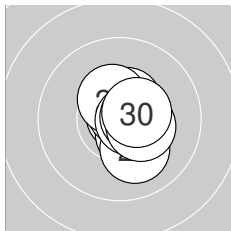

**Serie 3: 105.3 (100)**

10.5* ↑	10.9* ↑	10.5* ↓	10.1 ↓	10.7* ↑
10.4* ↖	10.7* →	10.6* →	10.4* →	10.5* ↗

beste Teiler: 22.3 (22.), 54.1 (25.), 67.4 (27.)  
 Trefferlage: 0.60 mm rechts, 0.02 mm hoch  
 Streuwert: 0.77, horizontal: 0.55, vertikal: 0.94



**Ergebnis: 308.1 (292)**  
**Serien: 102.9 101.5 103.7**  
**Zähler: 22 8 0 0 0 0 0 0 0 0**  
**Innenzehner: 20**  
**Weiteste: 446 (16.), 415 (5.), 291 (22.)**  
**beste Teiler: 49.9 (6.), 60.8 (17.), 81.5 (18.)**  
**Trefferlage: 0.05 mm rechts, 0.14 mm tief**  
**Streuwert: 1.42, horizontal: 1.38, vertikal: 1.47**

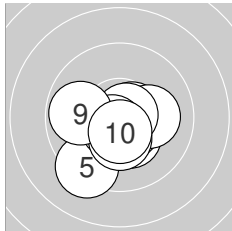
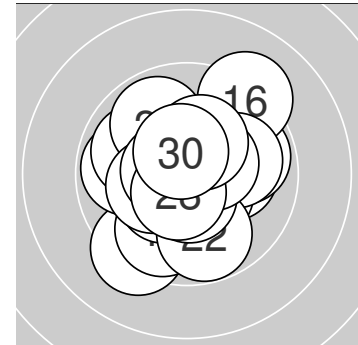

**Serie 1: 102.9 (98)**

10.3* ↘	10.6* →	10.6* ↘	10.1 →	9.3 ✓
10.8* →	10.6* ✓	10.3* ↓	9.8 ←	10.5* ↓

**beste Teiler: 49.9 (6.), 84.0 (7.), 91.4 (2.)**  
**Trefferlage: 0.07 mm links, 0.79 mm tief**  
**Streuwert: 1.32, horizontal: 1.46, vertikal: 1.15**

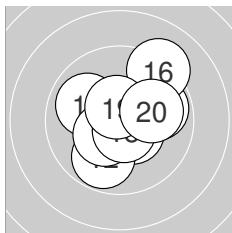

**Serie 2: 101.5 (96)**

10.5* ↘	9.8 ✓	9.9 ↖	10.4* ✓	9.8 →
9.2 ↗	10.7* ↑	10.6* ↓	10.6* ↑	10.0 →

**beste Teiler: 60.8 (17.), 81.5 (18.), 94.3 (19.)**  
**Trefferlage: 0.42 mm rechts, 0.24 mm hoch**  
**Streuwert: 1.68, horizontal: 1.71, vertikal: 1.64**

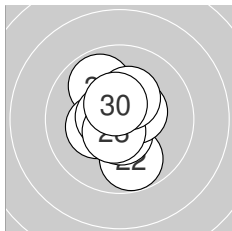

**Serie 3: 103.7 (98)**

9.9 ↖	9.8 ↓	10.3* ←	10.6* ↓	10.6* ↑
10.5* →	10.6* ←	10.6* ✓	10.3* ↑	10.5* ↑

**beste Teiler: 87.0 (25.), 90.6 (27.), 94.8 (28.)**  
**Trefferlage: 0.18 mm links, 0.12 mm hoch**  
**Streuwert: 1.23, horizontal: 0.91, vertikal: 1.48**



Ergebnis: **308.4** (296)  
 Serien: 102.9 103.0 102.5  
 Zähler: 26 4 0 0 0 0 0 0 0 0  
 Innenzehner: 17  
 Weitesten: 353 (22.), 303 (27.), 294 (26.)  
 beste Teiler: 20.0 (30.), 29.0 (21.), 62.0 (11.)  
 Trefferlage: 0.32 mm links, 0.79 mm hoch  
 Streuwert: 1.20, horizontal: 1.35, vertikal: 1.04

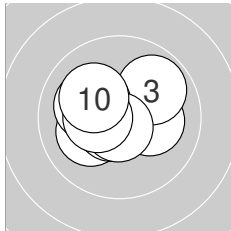
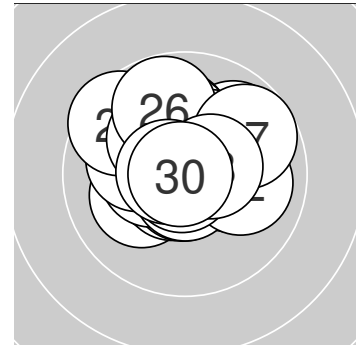

**Serie 1: 102.9 (99)**

10.2* →	10.1 ←	9.9 ↗	10.6* ←	10.6* ↘
10.2* ↖	10.7* ↓	10.1 ↖	10.4* ←	10.1 ↖

beste Teiler: 63.6 (7.), 80.0 (5.), 91.5 (4.)  
 Trefferlage: 0.59 mm links, 0.19 mm hoch  
 Streuwert: 1.24, horizontal: 1.49, vertikal: 0.91

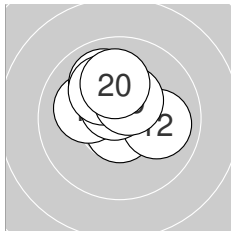

**Serie 2: 103.0 (100)**

10.7* ↓	10.0 →	10.1 ←	10.5* ↑	10.5* ↖
10.6* ↖	10.0 ↖	10.1 ↖	10.4* ↗	10.1 ↑

beste Teiler: 62.0 (11.), 89.3 (16.), 112.2 (14.)  
 Trefferlage: 0.23 mm links, 1.00 mm hoch  
 Streuwert: 1.07, horizontal: 1.16, vertikal: 0.96

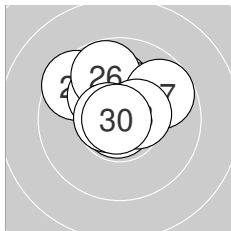

**Serie 3: 102.5 (97)**

10.8* ↘	9.5 ↖	10.1 ↑	10.3* ↗	10.2* ↖
9.8 ↖	9.7 ↗	10.5* →	10.7* ←	10.9* ←

beste Teiler: 20.0 (30.), 29.0 (21.), 72.6 (29.)  
 Trefferlage: 0.13 mm links, 1.17 mm hoch  
 Streuwert: 1.27, horizontal: 1.46, vertikal: 1.06



**Ergebnis: 312.7 (298)**  
**Serien: 104.6 104.5 103.6**  
**Zähler: 28 2 0 0 0 0 0 0 0 0 0**  
**Innenzehner: 26**  
**Weiteste: 331 (20.), 272 (1.), 245 (28.)**  
**beste Teiler: 10.1 (9.), 19.2 (23.), 21.1 (18.)**  
**Trefferlage: 0.13 mm rechts, 0.00 mm**  
**Streuwert: 1.09, horizontal: 1.16, vertikal: 1.01**

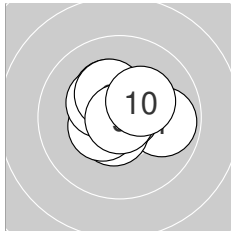
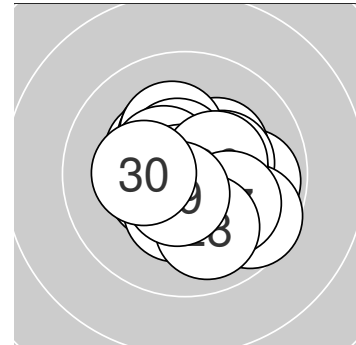

**Serie 1: 104.6 (99)**

9.9 →	10.3* ↖	10.6* ↓	10.8* ↗	10.7* ↖
10.5* ←	10.3* ↖	10.3* ↖	10.9* ↓	10.3* ↗

**beste Teiler: 10.1 (9.), 41.6 (4.), 56.0 (5.)**  
**Trefferlage: 0.00 mm , 0.36 mm hoch**  
**Streuwert: 1.04, horizontal: 1.21, vertikal: 0.84**

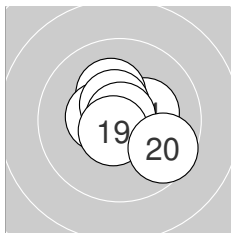

**Serie 2: 104.5 (99)**

10.7* ↖	10.5* ↖	10.7* →	10.3* →	10.2* ↖
10.5* ←	10.5* ↖	10.9* ↑	10.6* ↓	9.6 ↘

**beste Teiler: 21.1 (18.), 65.4 (13.), 71.8 (11.)**  
**Trefferlage: 0.12 mm rechts, 0.23 mm hoch**  
**Streuwert: 1.11, horizontal: 1.23, vertikal: 0.98**

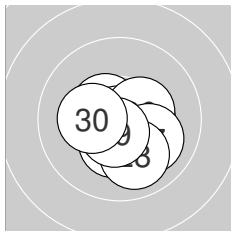

**Serie 3: 103.6 (100)**

10.3* ↓	10.5* ↖	10.9* ↗	10.4* →	10.2* ↘
10.4* →	10.1 ↘	10.0 ↓	10.6* ↓	10.2* ←

**beste Teiler: 19.2 (23.), 90.2 (29.), 113.6 (22.)**  
**Trefferlage: 0.28 mm rechts, 0.62 mm tief**  
**Streuwert: 1.08, horizontal: 1.16, vertikal: 0.98**



Ergebnis: **311.6** (297)  
 Serien: 104.0 102.1 105.5  
 Zähler: 28 1 1 0 0 0 0 0 0 0  
 Innenzehner: 25  
 Weitesten: 521 (19.), 355 (1.), 230 (16.)  
 beste Teiler: 16.0 (4.), 17.6 (23.), 26.1 (24.)  
 Trefferlage: 0.19 mm rechts, 0.20 mm tief  
 Streuwert: 1.23, horizontal: 1.45, vertikal: 0.96

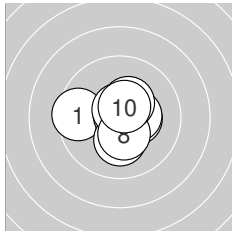
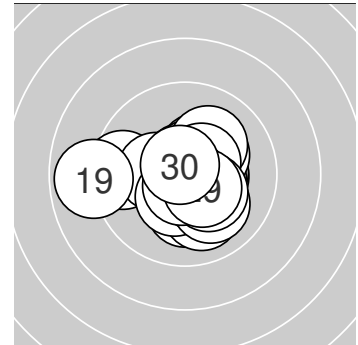

**Serie 1: 104.0 (99)**

9.5 ←	10.4* →	10.5* ↓	10.9* ↑	10.2* ↓
10.4* →	10.7* ↑	10.4* ↓	10.4* ↗	10.6* ↗

beste Teiler: 16.0 (4.), 67.0 (7.), 99.8 (10.)  
 Trefferlage: 0.08 mm rechts, 0.11 mm tief  
 Streuwert: 1.22, horizontal: 1.39, vertikal: 1.03

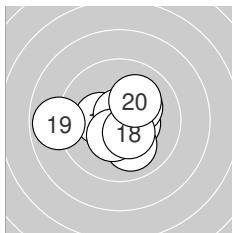

**Serie 2: 102.1 (98)**

10.6* ↗	10.4* →	10.2* ↗	10.3* ←	10.8* ↑
10.0 ↓	10.4* ↘	10.4* ↘	8.9 ←	10.1 ↗

beste Teiler: 48.0 (15.), 81.0 (11.), 129.2 (12.)  
 Trefferlage: 0.10 mm links, 0.12 mm tief  
 Streuwert: 1.65, horizontal: 2.04, vertikal: 1.13

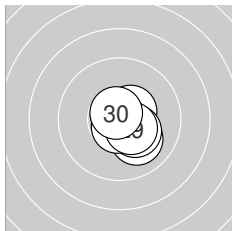

**Serie 3: 105.5 (100)**

10.7* →	10.5* ↗	10.9* ↘	10.8* ↖	10.4* ↘
10.1 ↘	10.3* ↘	10.7* ↓	10.4* ↘	10.7* ↖

beste Teiler: 17.6 (23.), 26.1 (24.), 60.4 (30.)  
 Trefferlage: 0.58 mm rechts, 0.38 mm tief  
 Streuwert: 0.71, horizontal: 0.66, vertikal: 0.76



# LG Mixed

StandNr: 14

Kreisser, Max #70402039

# Hobby

Wertung

StartNr: 153

07.02.2025 17:23

SG\_Bad-Häring / SG Bad-Häring 2

Ergebnis: **307.0** (290)  
 Serien: 103.3 103.8 99.9  
 Zähler: 20 10 0 0 0 0 0 0 0 0  
 Innenzehner: 17  
 Weitesten: 345 (28.), 339 (30.), 311 (29.)  
 beste Teiler: 25.4 (11.), 31.7 (1.), 33.4 (19.)  
 Trefferlage: 0.14 mm links, 0.69 mm hoch  
 Streuwert: 1.38, horizontal: 1.59, vertikal: 1.14

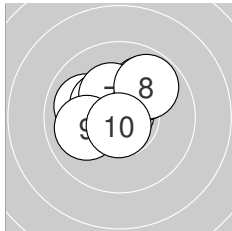
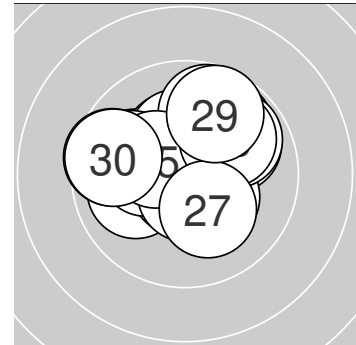

### Serie 1: 103.3 (98)

10.8* ↗	10.8* ←	9.9 ↗	10.6* ←	10.0 ←
10.4* ↘	10.3* ↗	9.8 ↗	10.0 ←	10.7* ↓

beste Teiler: 31.7 (1.), 42.2 (2.), 56.4 (10.)  
 Trefferlage: 0.41 mm links, 0.61 mm hoch  
 Streuwert: 1.22, horizontal: 1.40, vertikal: 1.01

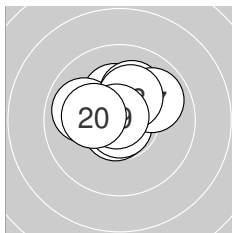

### Serie 2: 103.8 (98)

10.9* ↗	10.7* ↓	10.3* ↑	10.1 ↗	10.8* ↓
9.9 ←	9.9 ↗	10.2* ↗	10.8* ↘	10.2* ←

beste Teiler: 25.4 (11.), 33.4 (19.), 37.0 (15.)  
 Trefferlage: 0.11 mm links, 0.70 mm hoch  
 Streuwert: 1.12, horizontal: 1.32, vertikal: 0.88

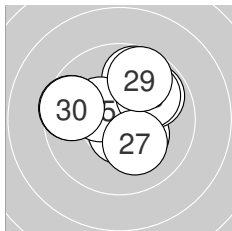

### Serie 3: 99.9 (94)

10.3* ↘	10.6* ↓	9.8 ↗	9.8 ↗	10.4* ↘
9.9 ↗	10.2* ↘	9.6 ←	9.7 ↗	9.6 ←

beste Teiler: 87.1 (22.), 150.2 (25.), 160.2 (21.)  
 Trefferlage: 0.09 mm rechts, 0.75 mm hoch  
 Streuwert: 1.83, horizontal: 2.07, vertikal: 1.54



**LG Mixed**

StandNr: 19

Zangerle, Johanna #80001448

**Hobby**

Wertung

SG\_Ebbser\_Schützen / SG Ebbser Schützen 1

**StartNr: 139**

07.02.2025 17:18

Ergebnis: **308.7** (294)  
 Serien: 105.0 101.7 102.0  
 Zähler: 25 4 1 0 0 0 0 0 0 0  
 Innenzehner: 22  
 Weitester: 554 (24.), 322 (16.), 273 (14.)  
 beste Teiler: 13.3 (28.), 28.4 (6.), 41.0 (4.)  
 Trefferlage: 0.34 mm rechts, 0.34 mm hoch  
 Streuwert: 1.36, horizontal: 1.53, vertikal: 1.16

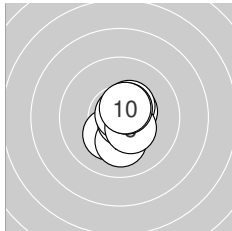
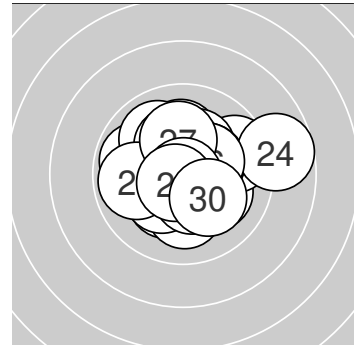
**Serie 1: 105.0 (100)**

10.2* ↙	10.1 ↓	10.6* →	10.8* ↘	10.5* ↗
10.8* ↑	10.4* ↗	10.4* ↘	10.6* ↗	10.6* ↗

beste Teiler: 28.4 (6.), 41.0 (4.), 91.1 (3.)  
 Trefferlage: 0.43 mm rechts, 0.11 mm tief  
 Streuwert: 0.86, horizontal: 0.60, vertikal: 1.06

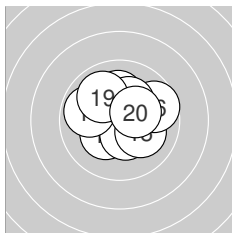
**Serie 2: 101.7 (97)**

10.7* ↑	10.3* ↙	10.4* ↓	9.9 ←	10.1 ↘
9.7 →	10.1 ↑	10.3* ↗	9.9 ↘	10.3* ↗

beste Teiler: 60.2 (11.), 134.4 (13.), 156.5 (20.)  
 Trefferlage: 0.20 mm rechts, 0.55 mm hoch  
 Streuwert: 1.49, horizontal: 1.68, vertikal: 1.28

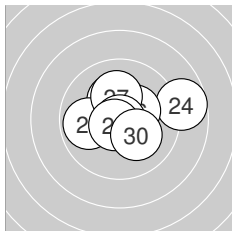
**Serie 3: 102.0 (97)**

10.5* ↑	10.3* ↖	9.9 ←	8.7 →	10.3* ↑
10.3* ↗	10.2* ↑	10.9* ↓	10.7* ↙	10.2* ↘

beste Teiler: 13.3 (28.), 67.2 (29.), 123.4 (21.)  
 Trefferlage: 0.41 mm rechts, 0.60 mm hoch  
 Streuwert: 1.68, horizontal: 2.09, vertikal: 1.12



**LG Mixed**

StandNr: 20

Patka, Walter #70407014

**Hobby**

Wertung

SG\_Ebbser\_Schützen / SG Ebbser Schützen 1

**StartNr: 140**

07.02.2025 17:17

Ergebnis: **308.0** (294)  
 Serien: 102.8 103.1 102.1  
 Zähler: 24 6 0 0 0 0 0 0 0 0  
 Innenzehner: 21  
 Weitesten: 420 (29.), 384 (21.), 356 (2.)  
 beste Teiler: 39.1 (3.), 39.4 (1.), 45.5 (14.)  
 Trefferlage: 0.37 mm rechts, 0.65 mm tief  
 Streuwert: 1.33, horizontal: 1.53, vertikal: 1.09

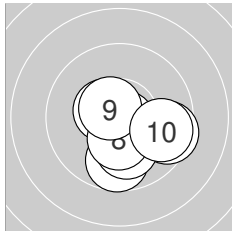
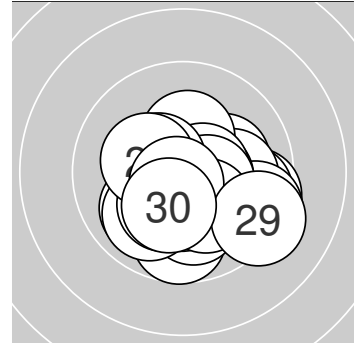
**Serie 1: 102.8 (97)**

10.8* ←	9.5 →	10.8* ↙	9.7 ↓	10.1 ↓
10.8* ↘	10.5* ↖	10.3* ↓	10.6* ↗	9.7 →

beste Teiler: 39.1 (3.), 39.4 (1.), 46.7 (6.)  
 Trefferlage: 0.44 mm rechts, 0.81 mm tief  
 Streuwert: 1.36, horizontal: 1.51, vertikal: 1.18

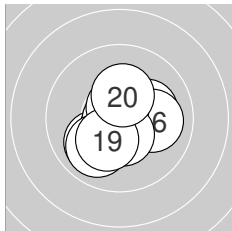
**Serie 2: 103.1 (99)**

10.2* →	10.0 ↙	10.6* ↘	10.8* ←	9.9 ↙
10.0 →	10.6* ↑	10.5* ↓	10.2* ↘	10.3* ↑

beste Teiler: 45.5 (14.), 77.2 (17.), 88.7 (13.)  
 Trefferlage: 0.07 mm links, 0.44 mm tief  
 Streuwert: 1.25, horizontal: 1.32, vertikal: 1.18

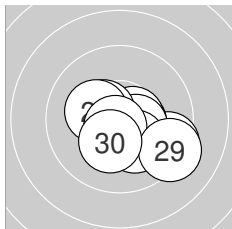
**Serie 3: 102.1 (98)**

9.4 →	10.5* →	10.6* →	10.5* →	10.4* ↖
10.2* ↘	10.2* ↖	10.7* ↘	9.3 →	10.3* ↘

beste Teiler: 64.0 (28.), 93.3 (23.), 113.3 (22.)  
 Trefferlage: 0.74 mm rechts, 0.71 mm tief  
 Streuwert: 1.44, horizontal: 1.77, vertikal: 1.00





Ergebnis: **307.8** (296)  
 Serien: 103.7 99.3 104.8 0.0  
 Zähler: 28 2 0 0 0 0 0 0 0 0 1  
ISSF 8.8.2.1a  
 Innenzehner: 22  
 Weitesten: 393 (15.), 251 (19.), 234 (12.)  
 beste Teiler: 58.1 (16.), 68.4 (8.), 69.0 (9.)  
 Trefferlage: 0.07 mm links, 0.02 mm tief  
 Streuwert: 1.22, horizontal: 1.48, vertikal: 0.90

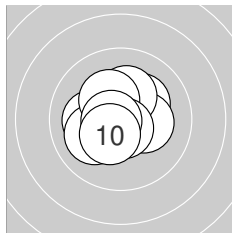
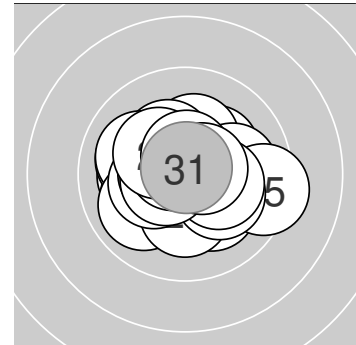

**Serie 1: 103.7 (100)**

10.2* ↗	10.6* ↗	10.1 ←	10.1 ←	10.3* →
10.3* ↑	10.3* ↘	10.7* ↓	10.7* ←	10.4* ↘

beste Teiler: 68.4 (8.), 69.0 (9.), 100.6 (2.)  
 Trefferlage: 0.21 mm links, 0.18 mm hoch  
 Streuwert: 1.16, horizontal: 1.27, vertikal: 1.03

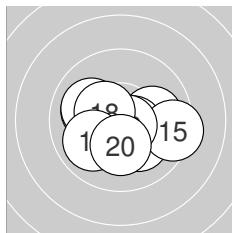

**Serie 2: 99.3 (96)**

10.1 ↘	10.0 →	10.6* ↘	10.0 ←	9.4 →
10.7* ↘	10.0 ←	10.4* ←	9.9 ←	10.2* ↓

beste Teiler: 58.1 (16.), 100.6 (13.), 133.2 (18.)  
 Trefferlage: 0.13 mm rechts, 0.40 mm tief  
 Streuwert: 1.61, horizontal: 2.04, vertikal: 1.00

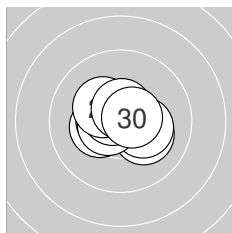

**Serie 3: 104.8 (100)**

10.3* ←	10.5* ←	10.7* ↘	10.2* ↘	10.3* →
10.6* ←	10.7* ↘	10.3* ↘	10.6* ↑	10.6* →

beste Teiler: 70.7 (23.), 74.0 (27.), 88.2 (30.)  
 Trefferlage: 0.16 mm links, 0.10 mm hoch  
 Streuwert: 0.95, horizontal: 1.18, vertikal: 0.64

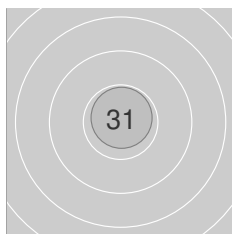

**Serie 4: 0.0 (0)**

0.0F ↑  
 beste Teiler:  
 Trefferlage: 0.07 mm rechts, 0.32 mm hoch  
 Streuwert: 0.00, horizontal: 0.00, vertikal: 0.00

ISSF 8.8.2.1a – zu viele Wertungsschüsse abgegeben (-2)



**Ergebnis: 308.8 (294)**  
**Serien: 103.3 104.1 101.4**  
**Zähler: 24 6 0 0 0 0 0 0 0 0 0**  
**Innenzehner: 21**  
**Weiteste: 343 (22.), 332 (23.), 303 (4.)**  
**beste Teiler: 20.0 (15.), 21.0 (13.), 36.8 (2.)**  
**Trefferlage: 0.19 mm links, 0.08 mm hoch**  
**Streuwert: 1.34, horizontal: 1.74, vertikal: 0.76**

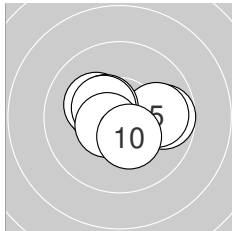
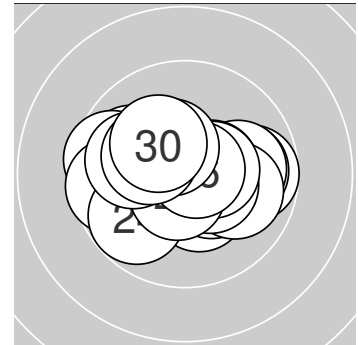

**Serie 1: 103.3 (98)**

10.4* ←	10.8* ↘	10.4* →	9.7 →	9.9 →
10.2* ←	10.5* ↘	10.4* ←	10.6* ↗	10.4* ↘

**beste Teiler: 36.8 (2.), 100.7 (9.), 119.4 (7.)**  
**Trefferlage: 0.20 mm rechts, 0.02 mm hoch**  
**Streuwert: 1.27, horizontal: 1.66, vertikal: 0.68**

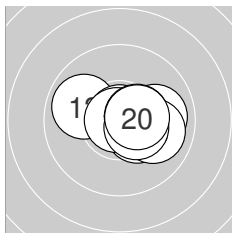

**Serie 2: 104.1 (99)**

10.5* →	9.9 ←	10.9* ↑	10.4* ↘	10.9* ←
10.0 →	10.5* →	10.0 →	10.5* →	10.5* →

**beste Teiler: 20.0 (15.), 21.0 (13.), 110.5 (11.)**  
**Trefferlage: 0.80 mm rechts, 0.02 mm tief**  
**Streuwert: 1.06, horizontal: 1.41, vertikal: 0.52**

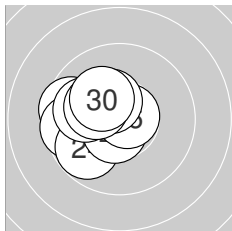

**Serie 3: 101.4 (97)**

10.3* ↘	9.6 ←	9.6 ←	9.8 ↙	10.6* ↘
10.7* →	10.4* ↘	10.0 ←	10.2* ↘	10.2* ↘

**beste Teiler: 57.0 (26.), 88.2 (25.), 140.9 (27.)**  
**Trefferlage: 1.60 mm links, 0.25 mm hoch**  
**Streuwert: 1.15, horizontal: 1.25, vertikal: 1.04**



**Ergebnis: 309.0 (296)**  
**Serien: 101.7 103.7 103.6**  
**Zähler: 26 4 0 0 0 0 0 0 0 0 0**  
**Innenzehner: 21**  
**Weiteste: 355 (4.), 320 (29.), 262 (8.)**  
**beste Teiler: 41.7 (5.), 84.0 (25.), 94.3 (30.)**  
**Trefferlage: 0.56 mm links, 0.35 mm hoch**  
**Streuwert: 1.19, horizontal: 1.36, vertikal: 0.99**

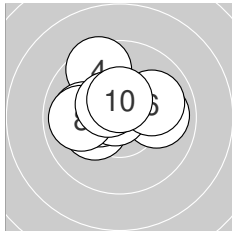
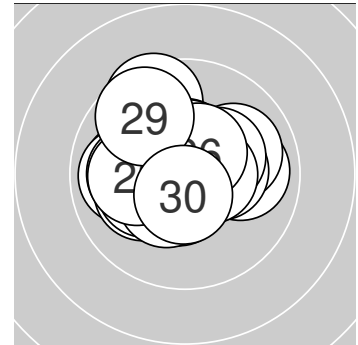

**Serie 1: 101.7 (97)**

9.9 →	10.2* ↙	10.4* ←	9.5 ↖	10.8* ↗
10.0 ↗	10.0 ←	9.9 ←	10.5* ↖	10.5* ↑

**beste Teiler: 41.7 (5.), 118.2 (9.), 120.0 (10.)**  
**Trefferlage: 0.58 mm links, 0.64 mm hoch**  
**Streuwert: 1.46, horizontal: 1.76, vertikal: 1.07**

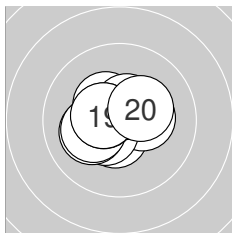

**Serie 2: 103.7 (100)**

10.5* ↓	10.3* →	10.4* ↘	10.4* ↖	10.1 ←
10.2* ↙	10.5* ↗	10.5* ←	10.5* ←	10.3* ↗

**beste Teiler: 104.6 (17.), 106.0 (11.), 112.0 (18.)**  
**Trefferlage: 0.45 mm links, 0.02 mm hoch**  
**Streuwert: 1.04, horizontal: 1.24, vertikal: 0.79**

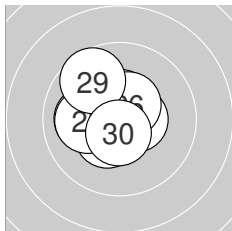

**Serie 3: 103.6 (99)**

10.5* ↑	10.1 ←	10.6* ↖	10.5* →	10.6* ↗
10.5* ↗	10.4* ↘	10.1 ←	9.7 ↖	10.6* ↓

**beste Teiler: 84.0 (25.), 94.3 (30.), 98.4 (23.)**  
**Trefferlage: 0.65 mm links, 0.40 mm hoch**  
**Streuwert: 1.12, horizontal: 1.14, vertikal: 1.09**



**Ergebnis: 307.4 (293)**  
**Serien: 102.4 102.2 102.8**  
**Zähler: 23 7 0 0 0 0 0 0 0 0**  
**Innenzehner: 19**  
**Weiteste: 370 (18.), 344 (21.), 335 (6.)**  
**beste Teiler: 48.0 (27.), 62.1 (9.), 68.0 (25.)**  
**Trefferlage: 0.32 mm links, 0.34 mm tief**  
**Streuwert: 1.41, horizontal: 1.39, vertikal: 1.44**

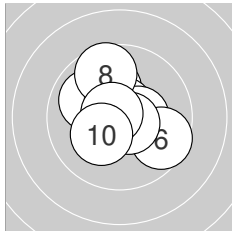
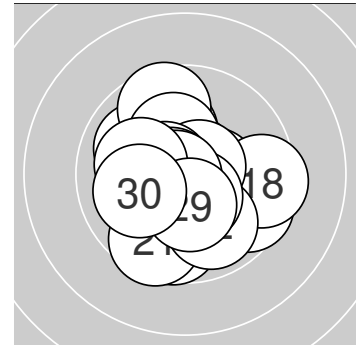

**Serie 1: 102.4 (98)**

10.1 ↑	10.5* ↘	10.7* ↑	10.4* →	10.0 ↘
9.6 ↘	10.6* ↘	9.6 ↑	10.7* ↘	10.2* ↘

**beste Teiler: 62.1 (9.), 69.5 (3.), 78.7 (7.)**  
**Trefferlage: 0.14 mm links, 0.47 mm hoch**  
**Streuwert: 1.46, horizontal: 1.49, vertikal: 1.42**

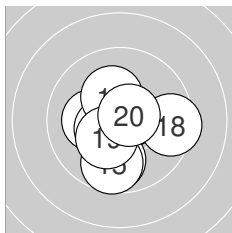

**Serie 2: 102.2 (97)**

10.7* ↘	10.2* ←	10.7* →	9.8 ↓	9.7 ↓
10.5* ↘	10.2* ↑	9.5 →	10.3* ↘	10.6* →

**beste Teiler: 70.1 (11.), 72.4 (13.), 76.9 (20.)**  
**Trefferlage: 0.07 mm links, 0.64 mm tief**  
**Streuwert: 1.49, horizontal: 1.53, vertikal: 1.46**

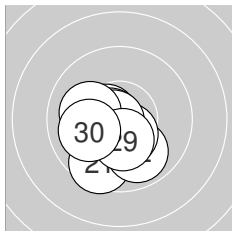

**Serie 3: 102.8 (98)**

9.6 ↘	9.9 ↘	10.6* ←	10.5* ↘	10.7* ←
10.2* ←	10.8* ←	10.1 ←	10.4* ↓	10.0 ←

**beste Teiler: 48.0 (27.), 68.0 (25.), 100.9 (23.)**  
**Trefferlage: 0.75 mm links, 0.86 mm tief**  
**Streuwert: 1.17, horizontal: 1.17, vertikal: 1.17**



# LG Mixed

StandNr: 21

Casazza, Renate #70401048

# Hobby

Wertung

StartNr: 162

07.02.2025 17:17

SG\_Angerberg / SG Angerberg 2

Ergebnis: **310.4** (295)  
 Serien: 102.6 103.5 104.3  
 Zähler: 25 5 0 0 0 0 0 0 0 0  
 Innenzehner: 20  
 Weitesten: 403 (14.), 268 (3.), 262 (27.)  
 beste Teiler: 17.4 (11.), 29.8 (12.), 35.0 (4.)  
 Trefferlage: 0.12 mm links, 0.59 mm hoch  
 Streuwert: 1.18, horizontal: 1.37, vertikal: 0.94

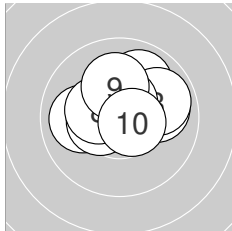
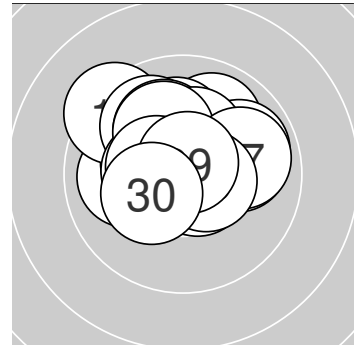

### Serie 1: 102.6 (98)

9.9 ↗	10.0 →	9.9 →	10.8* →	10.0 ←
10.4* ←	10.5* ↑	10.4* ↖	10.1 ↑	10.6* ↘

beste Teiler: 35.0 (4.), 88.7 (10.), 102.6 (7.)  
 Trefferlage: 0.21 mm rechts, 0.66 mm hoch  
 Streuwert: 1.31, horizontal: 1.62, vertikal: 0.91

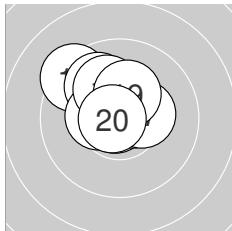

### Serie 2: 103.5 (98)

10.9* ↑	10.8* ←	10.6* →	9.3 ↘	9.9 ↘
10.4* ←	10.4* →	10.1 ↘	10.3* ↑	10.8* ←

beste Teiler: 17.4 (11.), 29.8 (12.), 49.1 (20.)  
 Trefferlage: 0.45 mm links, 0.90 mm hoch  
 Streuwert: 1.18, horizontal: 1.30, vertikal: 1.05

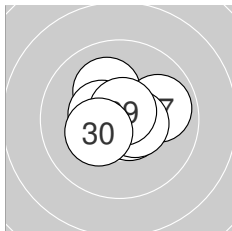

### Serie 3: 104.3 (99)

10.5* ←	10.6* ↖	10.6* ↘	10.1 ↘	10.6* ↘
10.5* ←	9.9 →	10.5* →	10.7* ↑	10.3* ↙

beste Teiler: 54.7 (29.), 77.1 (22.), 80.6 (25.)  
 Trefferlage: 0.15 mm links, 0.21 mm hoch  
 Streuwert: 1.04, horizontal: 1.24, vertikal: 0.78



Ergebnis: **305.1** (293)  
 Serien: 101.4 102.5 101.2  
 Zähler: 23 7 0 0 0 0 0 0 0 0  
 Innenzehner: 19  
 Weitestе: 483 (10.), 373 (13.), 372 (25.)  
 beste Teiler: 12.6 (23.), 51.6 (8.), 56.6 (28.)  
 Trefferlage: 0.24 mm rechts, 0.01 mm tief  
 Streuwert: 1.60, horizontal: 1.94, vertikal: 1.18

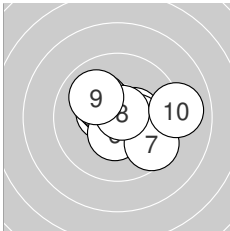
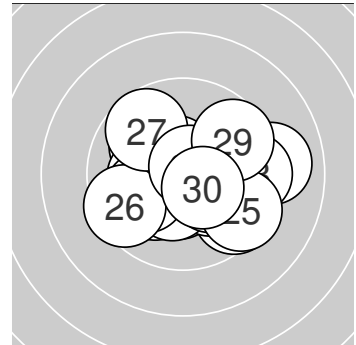

**Serie 1: 101.4 (98)**

10.4* →	10.5* ←	10.4* ↖	10.3* →	10.2* ↖
10.4* ↓	9.5 ↘	10.7* ↗	10.0 ↖	9.0 →

beste Teiler: 51.6 (8.), 122.7 (2.), 132.8 (6.)  
 Trefferlage: 0.53 mm rechts, 0.16 mm hoch  
 Streuwert: 1.69, horizontal: 2.10, vertikal: 1.16

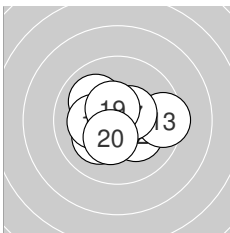

**Serie 2: 102.5 (99)**

10.4* →	10.2* ↘	9.5 →	10.7* ↓	10.0 ↖
10.1 ↙	10.5* ↗	10.2* ←	10.5* ↖	10.4* ↓

beste Teiler: 66.1 (14.), 104.7 (19.), 113.8 (17.)  
 Trefferlage: 0.09 mm rechts, 0.12 mm tief  
 Streuwert: 1.44, horizontal: 1.77, vertikal: 1.00

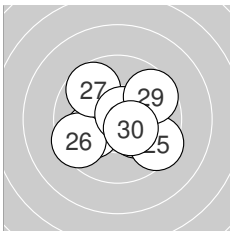

**Serie 3: 101.2 (96)**

10.6* ↖	10.2* ↘	10.9* ↑	10.1 ↙	9.5 ↘
9.5 ↙	9.7 ↖	10.7* ↗	9.6 ↗	10.4* ↘

beste Teiler: 12.6 (23.), 56.6 (28.), 96.0 (21.)  
 Trefferlage: 0.09 mm rechts, 0.09 mm tief  
 Streuwert: 1.81, horizontal: 2.11, vertikal: 1.45



**Ergebnis: 304.0** (288)  
**Serien:** 101.9 101.9 100.2  
**Zähler:** 19 10 1 0 0 0 0 0 0 0  
**Innenzehner:** 17  
**Weiteste:** 567 (30.), 453 (18.), 358 (3.)  
**beste Teiler:** 56.2 (2.), 58.5 (13.), 66.0 (17.)  
**Trefferlage:** 0.21 mm links, 0.68 mm hoch  
**Streuwert:** 1.64, horizontal: 1.76, vertikal: 1.52

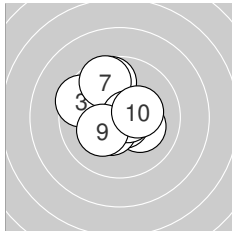
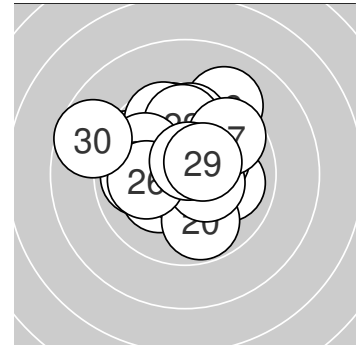

**Serie 1: 101.9 (97)**

10.2* ↘	10.7* ↘	9.5 ↖	9.7 ↑	10.6* ↙
10.4* ↙	9.6 ↑	10.7* →	10.2* ↖	10.3* →

**beste Teiler:** 56.2 (2.), 69.1 (8.), 79.9 (5.)  
**Trefferlage:** 0.37 mm links, 0.39 mm hoch  
**Streuwert:** 1.55, horizontal: 1.52, vertikal: 1.58

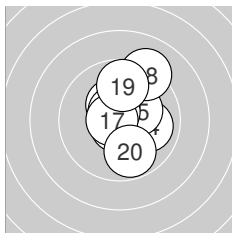

**Serie 2: 101.9 (97)**

10.6* ↑	10.4* ↘	10.7* ↙	10.0 →	10.3* ↗
10.6* ↘	10.7* ←	9.1 ↗	9.7 ↑	9.8 ↓

**beste Teiler:** 58.5 (13.), 66.0 (17.), 85.0 (11.)  
**Trefferlage:** 0.54 mm rechts, 0.70 mm hoch  
**Streuwert:** 1.55, horizontal: 1.16, vertikal: 1.86

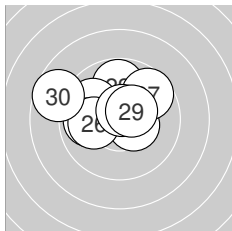

**Serie 3: 100.2 (94)**

10.6* ↘	9.8 ↑	9.9 ←	9.9 ↖	10.4* ↘
10.1 ←	9.7 ↗	10.6* ↑	10.5* ↗	8.7 ↖

**beste Teiler:** 77.6 (28.), 87.9 (21.), 124.5 (29.)  
**Trefferlage:** 0.82 mm links, 0.95 mm hoch  
**Streuwert:** 1.81, horizontal: 2.29, vertikal: 1.14



Ergebnis: **311.3** (295)  
 Serien: 104.4 102.2 104.7  
 Zähler: 25 5 0 0 0 0 0 0 0 0  
 Innenzehner: 22  
 Weitester: 332 (13.), 276 (22.), 273 (6.)  
 beste Teiler: 7.2 (1.), 12.0 (3.), 33.8 (12.)  
 Trefferlage: 0.18 mm rechts, 0.05 mm tief  
 Streuwert: 1.19, horizontal: 1.46, vertikal: 0.83

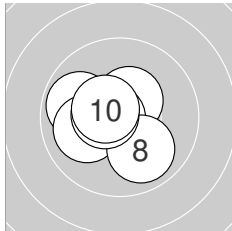
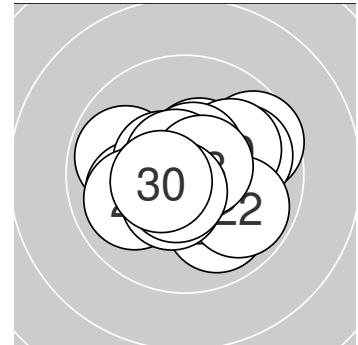

**Serie 1: 104.4 (98)**

10.9* ↘	10.6* ←	10.9* →	10.4* ↗	10.7* ←
9.9 ←	10.0 ←	9.9 ↘	10.6* ←	10.5* ↘

beste Teiler: 7.2 (1.), 12.0 (3.), 53.3 (5.)  
 Trefferlage: 0.58 mm links, 0.05 mm tief  
 Streuwert: 1.06, horizontal: 1.21, vertikal: 0.89

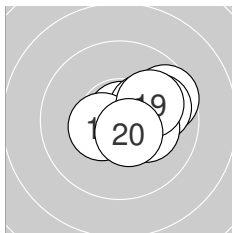

**Serie 2: 102.2 (98)**

10.2* →	10.8* ↗	9.6 →	10.3* ↗	10.2* →
9.9 →	10.5* ←	10.2* →	10.0 →	10.5* ↘

beste Teiler: 33.8 (12.), 102.2 (20.), 123.7 (17.)  
 Trefferlage: 1.39 mm rechts, 0.25 mm hoch  
 Streuwert: 1.02, horizontal: 1.22, vertikal: 0.77

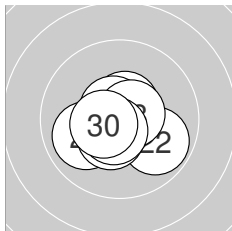

**Serie 3: 104.7 (99)**

10.6* ←	9.8 ↘	10.8* ←	10.6* ↗	10.0 ←
10.5* ↘	10.7* ↘	10.6* →	10.6* ↘	10.5* ←

beste Teiler: 47.1 (23.), 74.0 (27.), 83.6 (28.)  
 Trefferlage: 0.24 mm links, 0.34 mm tief  
 Streuwert: 1.02, horizontal: 1.21, vertikal: 0.79





**Ergebnis: 301.6 (288)**  
**Serien: 102.5 99.6 99.5**  
**Zähler: 19 10 1 0 0 0 0 0 0 0**  
**Innenzehner: 14**  
**Weiteste: 514 (19.), 453 (23.), 405 (30.)**  
**beste Teiler: 29.2 (7.), 46.4 (22.), 52.1 (29.)**  
**Trefferlage: 0.93 mm links, 0.87 mm tief**  
**Streuwert: 1.62, horizontal: 1.69, vertikal: 1.54**

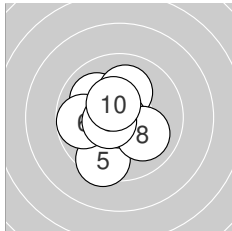
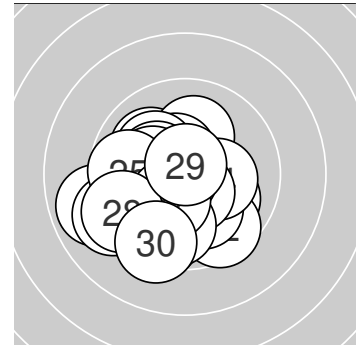

**Serie 1: 102.5 (98)**

10.0 ↘	10.7* ↙	10.5* ↓	10.1 ↑	9.5 ↓
9.8 ←	10.8* ↓	10.0 ↘	10.6* ←	10.5* ↖

**beste Teiler: 29.2 (7.), 55.9 (2.), 91.1 (9.)**  
**Trefferlage: 0.51 mm links, 0.26 mm tief**  
**Streuwert: 1.47, horizontal: 1.36, vertikal: 1.57**

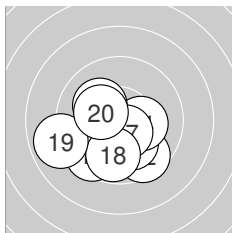

**Serie 2: 99.6 (95)**

10.6* ↘	9.6 ↘	10.1 ↓	10.2* →	9.5 ↙
10.1 ↖	10.5* ↓	9.8 ↓	8.9 ←	10.3* ↖

**beste Teiler: 79.1 (11.), 110.4 (17.), 167.5 (20.)**  
**Trefferlage: 0.51 mm links, 1.20 mm tief**  
**Streuwert: 1.81, horizontal: 2.09, vertikal: 1.46**

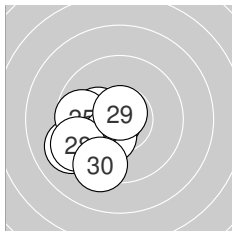

**Serie 3: 99.5 (95)**

10.5* ←	10.8* ←	9.1 ←	10.2* ←	9.7 ←
9.6 ↙	10.3* ↙	9.3 ←	10.7* ↑	9.3 ↓

**beste Teiler: 46.4 (22.), 52.1 (29.), 108.1 (21.)**  
**Trefferlage: 1.79 mm links, 1.14 mm tief**  
**Streuwert: 1.44, horizontal: 1.32, vertikal: 1.55**



Ergebnis: **312.7** (298)  
 Serien: 104.4 103.8 104.5  
 Zähler: 28 2 0 0 0 0 0 0 0 0  
 Innenzehner: 27  
 Weitestе: 315 (22.), 253 (7.), 221 (4.)  
 beste Teiler: 11.1 (21.), 31.6 (10.), 32.7 (2.)  
 Trefferlage: 0.05 mm links, 0.20 mm hoch  
 Streuwert: 1.04, horizontal: 1.05, vertikal: 1.04

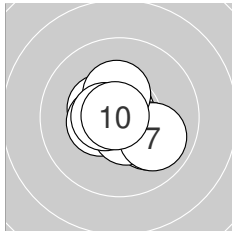
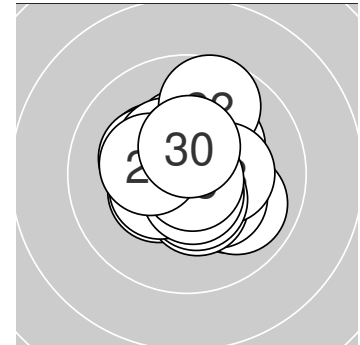

**Serie 1: 104.4 (99)**

10.6* ↖	10.8* ↑	10.4* ↙	10.1 ↘	10.4* ←
10.5* ↓	9.9 ↘	10.3* ↑	10.6* ←	10.8* ↖

beste Teiler: 31.6 (10.), 32.7 (2.), 85.4 (1.)  
 Trefferlage: 0.02 mm rechts, 0.03 mm tief  
 Streuwert: 1.06, horizontal: 1.18, vertikal: 0.91

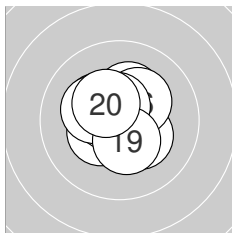

**Serie 2: 103.8 (100)**

10.3* ↙	10.4* ←	10.6* ↙	10.3* ↘	10.3* ↑
10.3* ↗	10.2* ↖	10.6* ↑	10.4* ↓	10.4* ↘

beste Teiler: 79.4 (13.), 94.5 (18.), 141.6 (19.)  
 Trefferlage: 0.26 mm links, 0.36 mm hoch  
 Streuwert: 1.06, horizontal: 1.09, vertikal: 1.03

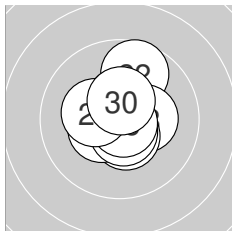

**Serie 3: 104.5 (99)**

10.9* ↙	9.7 ↑	10.3* →	10.5* ↓	10.4* ←
10.5* ↑	10.6* ↓	10.8* ↘	10.3* ←	10.5* ↑

beste Teiler: 11.1 (21.), 36.0 (28.), 87.9 (27.)  
 Trefferlage: 0.08 mm rechts, 0.28 mm hoch  
 Streuwert: 1.09, horizontal: 0.93, vertikal: 1.22



**Ergebnis: 304.1 (290)**  
**Serien: 102.2 100.7 101.2**  
**Zähler: 21 8 1 0 0 0 0 0 0 0 0**  
**Innenzehner: 15**  
**Weiteste: 566 (16.), 399 (25.), 366 (28.)**  
**beste Teiler: 53.1 (5.), 67.6 (21.), 86.8 (29.)**  
**Trefferlage: 0.51 mm links, 0.27 mm hoch**  
**Streuwert: 1.63, horizontal: 1.67, vertikal: 1.58**

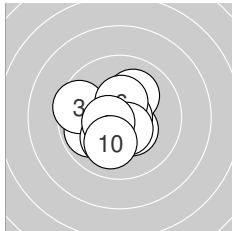
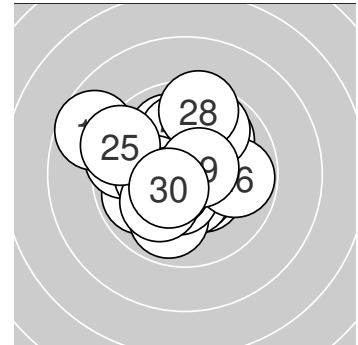

**Serie 1: 102.2 (98)**

10.4* ↘	9.9 ↙	9.5 ↖	10.1 ↗	10.7* →
10.4* ↑	10.1 ↘	10.5* ↘	10.5* ↙	10.1 ↘

**beste Teiler: 53.1 (5.), 104.3 (9.), 113.8 (8.)**  
**Trefferlage: 0.52 mm links, 0.34 mm tief**  
**Streuwert: 1.41, horizontal: 1.51, vertikal: 1.31**

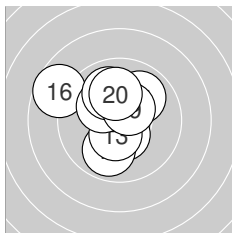

**Serie 2: 100.7 (96)**

10.5* ↓	9.9 ↓	10.5* ↓	9.9 ↗	10.4* ↖
8.7 ↖	10.2* ↖	10.0 ↖	10.5* ↗	10.1 ↑

**beste Teiler: 123.0 (13.), 123.0 (19.), 124.7 (11.)**  
**Trefferlage: 0.68 mm links, 0.74 mm hoch**  
**Streuwert: 1.77, horizontal: 1.80, vertikal: 1.74**

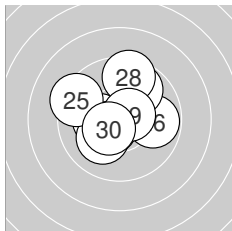

**Serie 3: 101.2 (96)**

10.7* ↙	10.3* ←	10.5* ↙	10.1 ↙	9.4 ↖
9.8 →	9.8 ↗	9.5 ↑	10.6* ↗	10.5* ↙

**beste Teiler: 67.6 (21.), 86.8 (29.), 104.7 (23.)**  
**Trefferlage: 0.32 mm links, 0.43 mm hoch**  
**Streuwert: 1.73, horizontal: 1.83, vertikal: 1.62**



**Ergebnis:** **309.9** (293)  
**Serien:** 101.9 104.9 103.1  
**Zähler:** 23 7 0 0 0 0 0 0 0 0 0  
**Innenzehner:** 21  
**Weiteste:** 444 (3.), 366 (24.), 344 (21.)  
**beste Teiler:** 8.0 (17.), 21.0 (30.), 23.2 (13.)  
**Trefferlage:** 0.47 mm rechts, 0.18 mm hoch  
**Streuwert:** 1.36, horizontal: 1.61, vertikal: 1.05

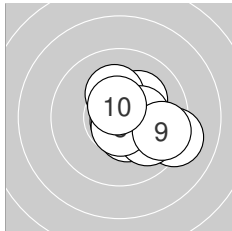
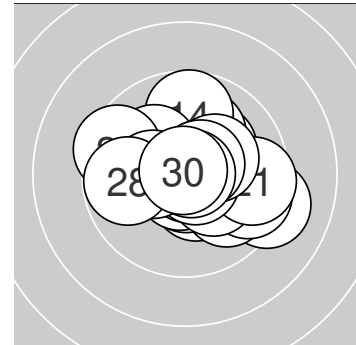

**Serie 1: 101.9 (97)**

10.8* ↓	10.2* ↗	9.2 →	10.2* ↑	10.3* →
10.4* ↓	9.9 ↘	10.7* ↓	9.6 →	10.6* ↑

**beste Teiler:** 28.0 (1.), 73.3 (8.), 92.1 (10.)  
**Trefferlage:** 1.25 mm rechts, 0.20 mm tief  
**Streuwert:** 1.38, horizontal: 1.55, vertikal: 1.19

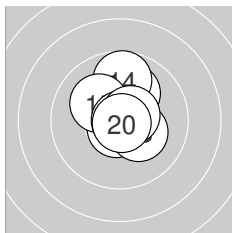

**Serie 2: 104.9 (99)**

10.7* ↓	10.1 ↑	10.9* ↑	9.7 ↑	10.1 ↘
10.8* →	10.9* →	10.3* ↘	10.6* →	10.8* ↘

**beste Teiler:** 8.0 (17.), 23.2 (13.), 27.2 (20.)  
**Trefferlage:** 0.22 mm rechts, 0.52 mm hoch  
**Streuwert:** 1.05, horizontal: 0.80, vertikal: 1.24

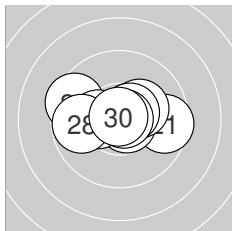

**Serie 3: 103.1 (97)**

9.6 →	10.7* ↘	10.6* ↗	9.5 ↖	10.3* ←
10.3* ↗	10.6* ↗	9.8 ←	10.8* →	10.9* ↑

**beste Teiler:** 21.0 (30.), 32.1 (29.), 64.1 (22.)  
**Trefferlage:** 0.06 mm links, 0.22 mm hoch  
**Streuwert:** 1.52, horizontal: 2.07, vertikal: 0.54



**LG Mixed**

StandNr: 25

**Simon, Sonja** #70402079**Hobby**

Wertung

**StartNr: 151**

07.02.2025 18:13

SG\_Bad-Häring / SG Bad-Häring 3

Ergebnis: **307.7** (295)  
 Serien: 101.8 101.7 104.2  
 Zähler: 25 5 0 0 0 0 0 0 0 0  
 Innenzehner: 19  
 Weitesten: 319 (12.), 299 (19.), 291 (7.)  
 beste Teiler: 14.1 (22.), 23.0 (27.), 47.1 (13.)  
 Trefferlage: 0.59 mm links, 0.00 mm  
 Streuwert: 1.31, horizontal: 1.47, vertikal: 1.13

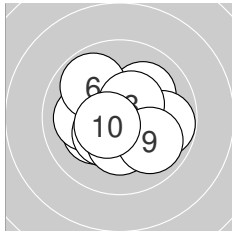
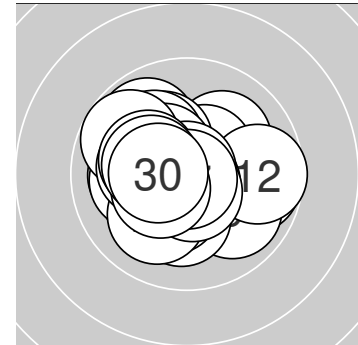
**Serie 1: 101.8 (97)**

10.2* ↙	10.1 ←	10.4* ↘	10.3* ↓	10.1 ↗
9.9 ↘	9.8 →	10.5* ↗	9.9 ↘	10.6* ↙

beste Teiler: 99.3 (10.), 119.0 (8.), 145.8 (3.)  
 Trefferlage: 0.01 mm links, 0.17 mm tief  
 Streuwert: 1.55, horizontal: 1.77, vertikal: 1.29

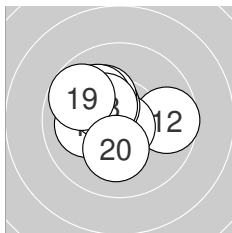
**Serie 2: 101.7 (98)**

10.1 ←	9.7 →	10.8* ↓	10.0 ↘	10.4* ↘
10.2* ↘	10.1 ↘	10.4* ↘	9.8 ↘	10.2* ↓

beste Teiler: 47.1 (13.), 129.4 (15.), 140.8 (18.)  
 Trefferlage: 0.80 mm links, 0.53 mm hoch  
 Streuwert: 1.42, horizontal: 1.63, vertikal: 1.16

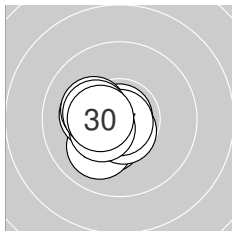
**Serie 3: 104.2 (100)**

10.3* ↙	10.9* ↑	10.0 ↘	10.6* ↓	10.2* ←
10.2* ↙	10.9* ↓	10.4* ↙	10.3* ←	10.4* ←

beste Teiler: 14.1 (22.), 23.0 (27.), 83.8 (24.)  
 Trefferlage: 0.95 mm links, 0.33 mm tief  
 Streuwert: 0.80, horizontal: 0.78, vertikal: 0.81



Ergebnis: **305.5** (292)  
 Serien: 101.2 102.1 102.2  
 Zähler: 22 8 0 0 0 0 0 0 0 0  
 Innenzehner: 19  
 Weitesten: 460 (6.), 344 (12.), 343 (29.)  
 beste Teiler: 25.2 (30.), 36.2 (24.), 51.4 (5.)  
 Trefferlage: 0.26 mm links, 1.01 mm tief  
 Streuwert: 1.36, horizontal: 1.48, vertikal: 1.22

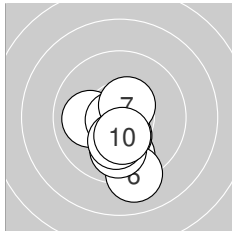
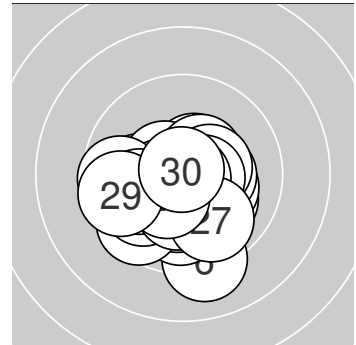

**Serie 1: 101.2 (97)**

10.0 ←	9.7 ↓	10.4* ↓	10.3* ↓	10.7* ↙
9.1 ↓	10.5* ↗	9.9 ↓	10.2* ↓	10.4* ↓

beste Teiler: 51.4 (5.), 111.3 (7.), 148.0 (3.)  
 Trefferlage: 0.04 mm links, 1.57 mm tief  
 Streuwert: 1.28, horizontal: 0.93, vertikal: 1.55

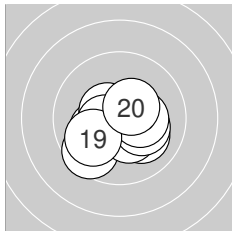

**Serie 2: 102.1 (98)**

10.1 ↘	9.6 ↗	10.2* ↙	10.5* ↘	10.5* ↙
10.4* ↘	10.2* ↘	10.3* →	9.9 ↙	10.4* ↗

beste Teiler: 111.5 (14.), 121.1 (15.), 128.7 (20.)  
 Trefferlage: 0.14 mm links, 0.73 mm tief  
 Streuwert: 1.38, horizontal: 1.66, vertikal: 1.03

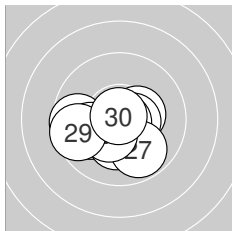

**Serie 3: 102.2 (97)**

9.6 ←	10.4* →	10.5* →	10.8* ↘	10.0 ↙
10.2* ↓	9.8 ↘	10.4* ↙	9.6 ←	10.9* ↗

beste Teiler: 25.2 (30.), 36.2 (24.), 103.5 (23.)  
 Trefferlage: 0.58 mm links, 0.72 mm tief  
 Streuwert: 1.42, horizontal: 1.81, vertikal: 0.88



**Ergebnis: 306.4 (292)**  
**Serien: 100.6 103.9 101.9**  
**Zähler: 23 6 1 0 0 0 0 0 0 0**  
**Innenzehner: 17**  
**Weiteste: 517 (9.), 366 (26.), 321 (1.)**  
**beste Teiler: 27.7 (24.), 38.9 (15.), 60.1 (29.)**  
**Trefferlage: 0.58 mm links, 0.00 mm**  
**Streuwert: 1.50, horizontal: 1.88, vertikal: 0.98**

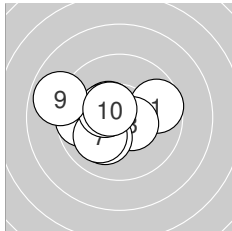
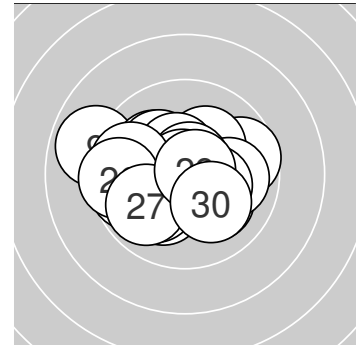

**Serie 1: 100.6 (96)**

9.7 →	10.2* ←	10.5* ↘	10.1 ↙	9.7 ←
10.5* ↘	10.1 ↙	10.4* ↘	8.9 ←	10.5* ↘

**beste Teiler: 105.7 (10.), 113.1 (3.), 118.8 (6.)**  
**Trefferlage: 1.15 mm links, 0.05 mm hoch**  
**Streuwert: 1.69, horizontal: 2.15, vertikal: 1.06**

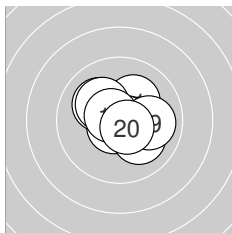

**Serie 2: 103.9 (100)**

10.2* ↗	10.6* ↘	10.7* ↙	10.1 ↘	10.8* ↘
10.1 ↘	10.2* ↘	10.6* ↘	10.0 →	10.6* ↘

**beste Teiler: 38.9 (15.), 72.9 (13.), 79.6 (18.)**  
**Trefferlage: 0.26 mm rechts, 0.13 mm hoch**  
**Streuwert: 1.17, horizontal: 1.33, vertikal: 0.98**

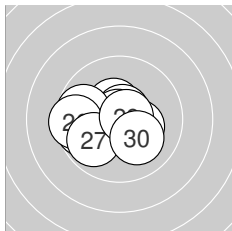

**Serie 3: 101.9 (96)**

10.5* ↘	10.7* ↗	9.7 ←	10.8* ↘	9.7 ←
9.5 ←	9.9 ↙	10.3* ↘	10.7* ↗	10.1 ↘

**beste Teiler: 27.7 (24.), 60.1 (29.), 68.3 (22.)**  
**Trefferlage: 0.87 mm links, 0.20 mm tief**  
**Streuwert: 1.52, horizontal: 1.93, vertikal: 0.96**



**LG Mixed**

StandNr: 23

Siedler, Thomas #70401063

**Hobby**

Wertung

**StartNr: 158**

07.02.2025 16:12

SG\_Angerberg / SG Angerberg 3

Ergebnis: **305.2** (291)  
 Serien: 102.8 101.6 100.8  
 Zähler: 21 9 0 0 0 0 0 0 0 0  
 Innenzehner: 14  
 Weitestе: 409 (27.), 399 (23.), 374 (21.)  
 beste Teiler: 8.9 (28.), 23.0 (2.), 23.2 (26.)  
 Trefferlage: 0.26 mm rechts, 1.19 mm tief  
 Streuwert: 1.35, horizontal: 1.41, vertikal: 1.29

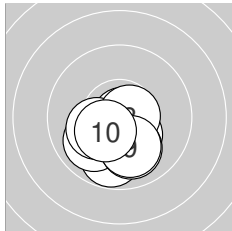
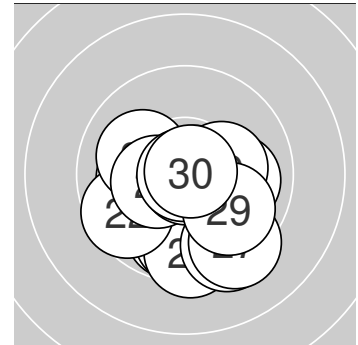
**Serie 1: 102.8 (98)**

10.5* ↘	10.9* →	10.3* ↘	9.8 ↓	9.9 ↙
10.0 ↓	10.2* ↙	10.7* →	10.1 ↓	10.4* ↙

beste Teiler: 23.0 (2.), 71.5 (8.), 104.6 (1.)  
 Trefferlage: 0.12 mm links, 1.28 mm tief  
 Streuwert: 1.01, horizontal: 1.07, vertikal: 0.94

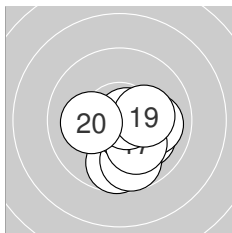
**Serie 2: 101.6 (98)**

9.7 ↓	10.1 ↘	9.7 ↓	10.4* →	10.6* ↘
10.0 →	10.1 ↘	10.7* →	10.2* →	10.1 ←

beste Teiler: 52.1 (18.), 84.8 (15.), 135.0 (14.)  
 Trefferlage: 0.81 mm rechts, 0.95 mm tief  
 Streuwert: 1.25, horizontal: 1.26, vertikal: 1.24

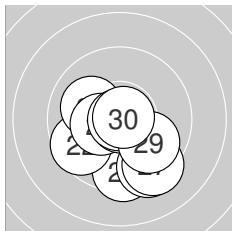
**Serie 3: 100.8 (95)**

9.5 ↓	9.6 ↙	9.4 ↘	10.1 ↖	10.4* ↙
10.9* ↘	9.3 ↘	10.9* ↙	9.9 ↘	10.8* →

beste Teiler: 8.9 (28.), 23.2 (26.), 30.8 (30.)  
 Trefferlage: 0.09 mm rechts, 1.36 mm tief  
 Streuwert: 1.73, horizontal: 1.77, vertikal: 1.68

