

Ergebnis: **416.4** (397)
 Serien: 101.6 105.2 104.2 105.4
 Zähler: 37 3 0 0 0 0 0 0 0 0
 Innenzehner: 31
 Weitest: 278 (5.), 266 (7.), 253 (6.)
 beste Teiler: 26.2 (12.), 33.9 (34.), 41.6 (35.)
 Trefferlage: 0.08 mm rechts, 0.18 mm hoch
 Streuwert: 1.10, horizontal: 0.94, vertikal: 1.25

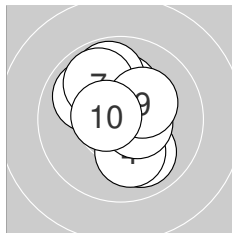
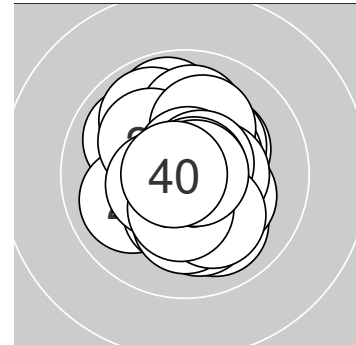

Serie 1: 101.6 (97)

10.0 ↘	10.3* ↑	10.2* ↑	10.1 ↓	9.8 ↑
9.9 ↖	9.9 ↖	10.5* →	10.3* ↗	10.6* ↖

beste Teiler: 93.6 (10.), 108.9 (8.), 173.2 (2.)
 Trefferlage: 0.10 mm links, 0.68 mm hoch
 Streuwert: 1.47, horizontal: 1.19, vertikal: 1.69

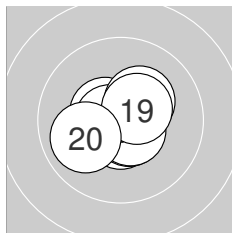

Serie 2: 105.2 (100)

10.5* ↖	10.8* ↘	10.6* ↓	10.6* ↗	10.6* ↘
10.7* ←	10.3* ↗	10.6* ↘	10.5* ↗	10.0 ↖

beste Teiler: 26.2 (12.), 67.0 (16.), 86.0 (13.)
 Trefferlage: 0.04 mm rechts, 0.05 mm tief
 Streuwert: 0.92, horizontal: 1.06, vertikal: 0.77

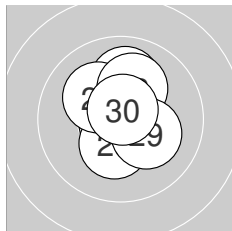

Serie 3: 104.2 (100)

10.0 ↑	10.8* ↙	10.3* ↓	10.6* ↗	10.6* ↑
10.7* ↗	10.2* ↖	10.1 ↑	10.2* ↘	10.7* ↑

beste Teiler: 50.9 (22.), 61.3 (30.), 71.0 (26.)
 Trefferlage: 0.15 mm rechts, 0.57 mm hoch
 Streuwert: 1.03, horizontal: 0.81, vertikal: 1.22

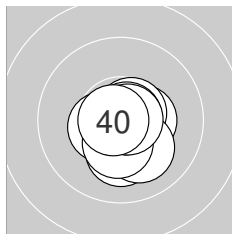

Serie 4: 105.4 (100)

10.4* →	10.2* ↓	10.6* ↗	10.8* →	10.8* ↗
10.5* ↖	10.1 ↘	10.4* ↓	10.8* →	10.8* ←

beste Teiler: 33.9 (34.), 41.6 (35.), 44.1 (39.)
 Trefferlage: 0.25 mm rechts, 0.48 mm tief
 Streuwert: 0.81, horizontal: 0.73, vertikal: 0.88



Ergebnis: 402.3 (382)
Serien: 101.3 101.8 98.7 100.5
Zähler: 22 18 0 0 0 0 0 0 0 0
Innenzehner: 15
Weiteste: 393 (3.), 386 (22.), 368 (2.)
beste Teiler: 0.0 (40.), 27.0 (8.), 52.3 (26.)
Trefferlage: 1.47 mm links, 0.10 mm hoch
Streuwert: 1.43, horizontal: 1.27, vertikal: 1.56

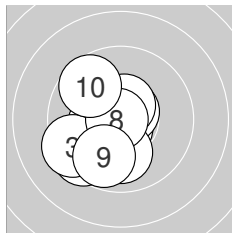
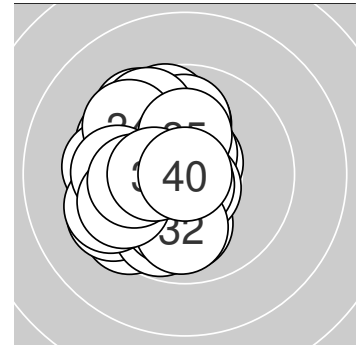

Serie 1: 101.3 (96)

10.3* ←	9.5 ↙	9.4 ↙	10.7* ↓	10.6* ↗
10.0 ↓	10.5* ↑	10.8* ←	9.8 ↙	9.7 ↘

beste Teiler: 27.0 (8.), 65.3 (4.), 77.0 (5.)
Trefferlage: 1.03 mm links, 0.64 mm tief
Streuwert: 1.55, horizontal: 1.38, vertikal: 1.70

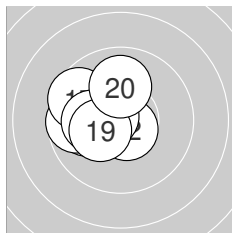

Serie 2: 101.8 (98)

10.5* ←	10.6* ↘	10.4* ←	10.0 ←	10.6* ←
9.7 ←	9.6 ↘	10.1 ←	10.3* ←	10.0 ↑

beste Teiler: 78.4 (12.), 96.8 (15.), 113.6 (11.)
Trefferlage: 1.50 mm links, 0.21 mm hoch
Streuwert: 1.09, horizontal: 1.17, vertikal: 1.00

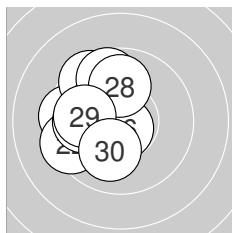

Serie 3: 98.7 (93)

9.5 ←	9.4 ↙	9.9 ←	9.5 ↘	10.1 ↘
10.7* ↓	9.7 ↑	9.9 ↑	9.9 ←	10.1 ↓

beste Teiler: 52.3 (26.), 211.3 (25.), 220.5 (30.)
Trefferlage: 1.83 mm links, 0.55 mm hoch
Streuwert: 1.57, horizontal: 1.36, vertikal: 1.77

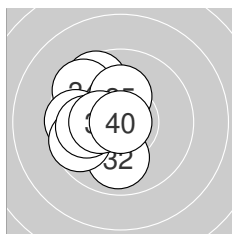

Serie 4: 100.5 (95)

9.6 ↘	9.9 ↓	10.6* ←	9.5 ↘	10.2* ↑
9.7 ←	9.7 ↙	10.0 ←	10.4* ←	10.9* →

beste Teiler: 0.0 (40.), 87.9 (33.), 148.0 (39.)
Trefferlage: 1.55 mm links, 0.30 mm hoch
Streuwert: 1.46, horizontal: 1.24, vertikal: 1.64



Ergebnis: 409.0 (390)
Serien: 102.5 99.9 103.0 103.6
Zähler: 31 8 1 0 0 0 0 0 0 0
Innenzehner: 25
Weiteste: 514 (17.), 422 (36.), 366 (8.)
beste Teiler: 4.0 (34.), 15.1 (33.), 21.1 (30.)
Trefferlage: 0.14 mm links, 0.55 mm hoch
Streuwert: 1.50, horizontal: 1.64, vertikal: 1.34

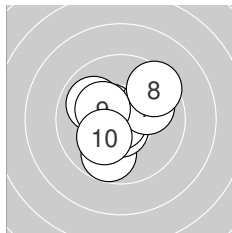
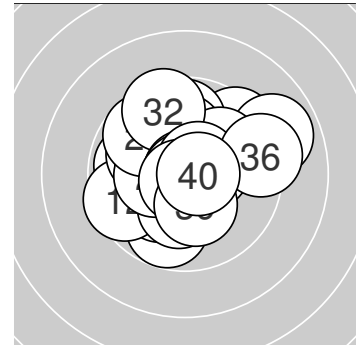

Serie 1: 102.5 (98)

10.8* ←	9.8 ↓	10.6* ↓	10.0 ↖	10.8* ↓
10.5* ↖	10.0 ↗	9.5 ↗	10.3* ↖	10.2* ↗

beste Teiler: 26.4 (5.), 37.0 (1.), 83.0 (3.)
Trefferlage: 0.24 mm links, 0.08 mm hoch
Streuwert: 1.53, horizontal: 1.56, vertikal: 1.50

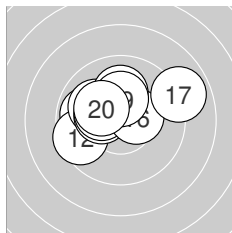

Serie 2: 99.9 (96)

9.9 ←	9.5 ←	10.0 ↖	10.3* ←	10.3* ↖
10.4* →	8.9 ↗	10.1 ↑	10.3* ↑	10.2* ↖

beste Teiler: 130.4 (16.), 157.4 (14.), 164.3 (15.)
Trefferlage: 0.66 mm links, 0.84 mm hoch
Streuwert: 1.80, horizontal: 2.32, vertikal: 1.05

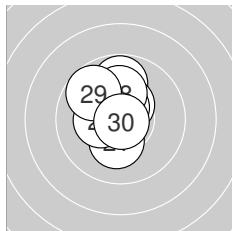

Serie 3: 103.0 (98)

10.2* ↓	10.3* ↑	9.8 ↑	10.7* ↑	10.4* ↑
10.3* ←	10.6* ↑	10.1 ↑	9.7 ↖	10.9* ↓

beste Teiler: 21.1 (30.), 59.5 (24.), 94.4 (27.)
Trefferlage: 0.38 mm links, 0.94 mm hoch
Streuwert: 1.14, horizontal: 0.84, vertikal: 1.38

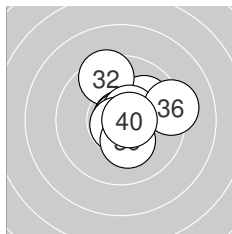

Serie 4: 103.6 (98)

10.0 ↗	9.5 ↑	10.9* ↑	10.9* ←	10.6* ↗
9.3 →	10.6* ↓	10.8* ↓	10.3* ↓	10.7* →

beste Teiler: 4.0 (34.), 15.1 (33.), 44.6 (38.)
Trefferlage: 0.69 mm rechts, 0.36 mm hoch
Streuwert: 1.41, horizontal: 1.43, vertikal: 1.40



Ergebnis: 411.2 (392)
Serien: 102.3 103.0 103.1 102.8
Zähler: 32 8 0 0 0 0 0 0 0 0
Innenzehner: 27
Weiteste: 358 (28.), 353 (2.), 347 (8.)
beste Teiler: 32.0 (38.), 49.0 (27.), 52.8 (11.)
Trefferlage: 0.52 mm links, 0.25 mm tief
Streuwert: 1.29, horizontal: 1.32, vertikal: 1.26

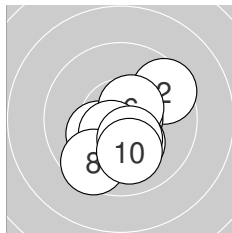
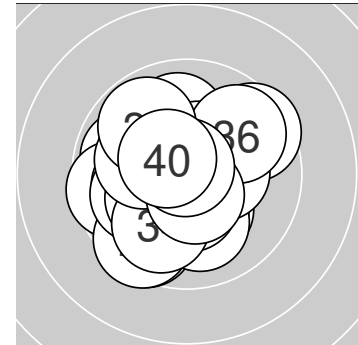

Serie 1: 102.3 (98)

10.2* ↙	9.5 ↗	10.7* →	10.7* →	10.2* ↓
10.5* ↗	10.5* ↙	9.6 ↙	10.4* ↓	10.0 ↓

beste Teiler: 63.1 (3.), 64.0 (4.), 106.2 (6.)
Trefferlage: 0.29 mm rechts, 0.72 mm tief
Streuwert: 1.40, horizontal: 1.36, vertikal: 1.44

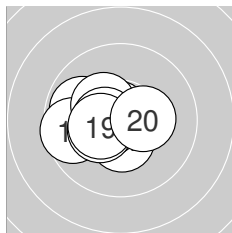

Serie 2: 103.0 (98)

10.7* ↘	9.9 ↖	9.6 ←	10.4* ↓	10.3* ↖
10.6* ←	10.3* ↙	10.5* ←	10.4* ←	10.3* →

beste Teiler: 52.8 (11.), 81.5 (16.), 108.0 (18.)
Trefferlage: 1.03 mm links, 0.09 mm tief
Streuwert: 1.08, horizontal: 1.35, vertikal: 0.71

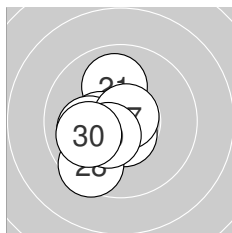

Serie 3: 103.1 (99)

10.0 ↑	10.4* ←	10.6* ↙	10.7* ↓	10.6* ↓
10.1 ←	10.8* ↗	9.5 ↙	10.4* ↙	10.0 ←

beste Teiler: 49.0 (27.), 60.2 (24.), 90.5 (25.)
Trefferlage: 0.90 mm links, 0.48 mm tief
Streuwert: 1.16, horizontal: 0.99, vertikal: 1.32

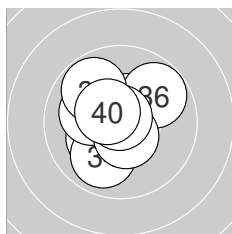

Serie 4: 102.8 (97)

10.2* ↙	10.5* ↗	10.7* ↗	9.9 ↙	10.1 ↖
9.8 ↗	10.5* ↓	10.8* ↑	9.8 ↘	10.5* ↖

beste Teiler: 32.0 (38.), 55.6 (33.), 101.0 (37.)
Trefferlage: 0.44 mm links, 0.30 mm hoch
Streuwert: 1.34, horizontal: 1.30, vertikal: 1.37



Ergebnis: 398.5 (382)
Serien: 99.0 101.1 97.0 101.4
Zähler: 23 16 1 0 0 0 0 0 0 0
Innenzehner: 12
Weiteste: 547 (23.), 468 (6.), 396 (28.)
beste Teiler: 46.0 (40.), 49.0 (14.), 86.3 (3.)
Trefferlage: 1.12 mm links, 0.51 mm hoch
Streuwert: 1.75, horizontal: 2.10, vertikal: 1.30

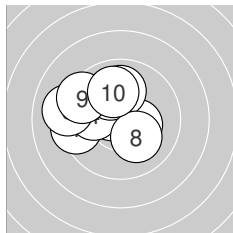
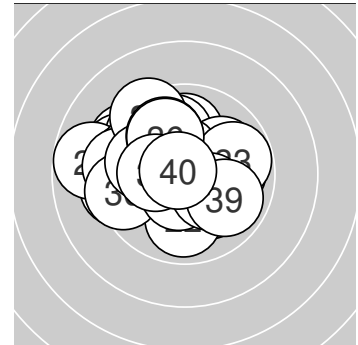

Serie 1: 99.0 (97)

9.4 ←	10.4* →	10.6* ↖	10.0 ←	10.0 ↑
9.1 ←	10.0 ↑	10.1 ↘	9.4 ↖	10.0 ↑

beste Teiler: 86.3 (3.), 149.8 (2.), 206.1 (8.)
Trefferlage: 1.37 mm links, 0.76 mm hoch
Streuwert: 1.80, horizontal: 2.11, vertikal: 1.43

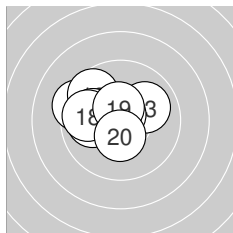

Serie 2: 101.1 (97)

9.4 ↖	9.6 ↘	10.0 →	10.8* ↑	10.6* ↓
10.0 ←	10.0 ←	9.8 ←	10.5* ↑	10.4* ↓

beste Teiler: 49.0 (14.), 99.0 (15.), 112.4 (19.)
Trefferlage: 1.23 mm links, 0.47 mm hoch
Streuwert: 1.48, horizontal: 1.80, vertikal: 1.08

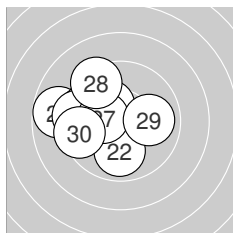

Serie 3: 97.0 (92)

10.3* ↘	9.9 ↓	8.8 ←	9.6 ←	9.8 ↖
9.4 ←	10.3* ←	9.4 ↘	10.0 →	9.5 ←

beste Teiler: 154.9 (27.), 170.2 (21.), 248.2 (29.)
Trefferlage: 2.07 mm links, 0.51 mm hoch
Streuwert: 1.91, horizontal: 2.21, vertikal: 1.56

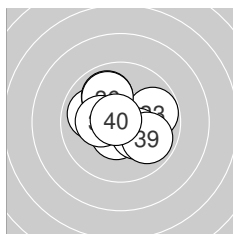

Serie 4: 101.4 (96)

9.9 ←	10.0 →	9.8 →	10.5* ↓	9.9 ↘
10.0 ↘	10.3* ↘	10.3* ←	9.9 ↘	10.8* ↖

beste Teiler: 46.0 (40.), 109.4 (34.), 172.1 (38.)
Trefferlage: 0.16 mm rechts, 0.30 mm hoch
Streuwert: 1.60, horizontal: 1.89, vertikal: 1.25



Ergebnis: **413.4** (394)
 Serien: 103.9 102.8 101.7 105.0
 Zähler: 34 6 0 0 0 0 0 0 0 0 0
 Innenzehner: 33
 Weitestе: 451 (18.), 362 (27.), 331 (19.)
 beste Teiler: 6.0 (30.), 41.4 (36.), 49.0 (15.)
 Trefferlage: 0.15 mm rechts, 0.19 mm hoch
 Streuwert: 1.28, horizontal: 1.47, vertikal: 1.05

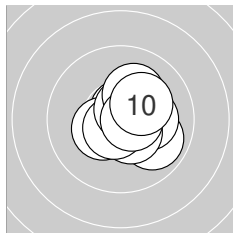
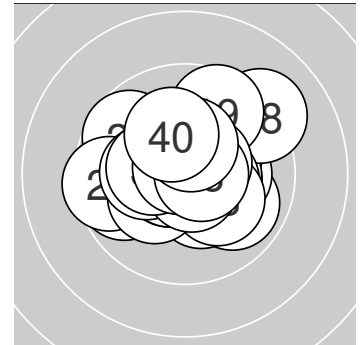

Serie 1: 103.9 (99)

10.7* ↑	9.9 ↘	10.2* →	10.4* ←	10.5* ↘
10.6* ↙	10.6* ↗	10.2* ↗	10.6* →	10.2* ↗

beste Teiler: 62.2 (1.), 76.4 (6.), 78.7 (7.)
 Trefferlage: 0.67 mm rechts, 0.05 mm hoch
 Streuwert: 1.02, horizontal: 1.07, vertikal: 0.98

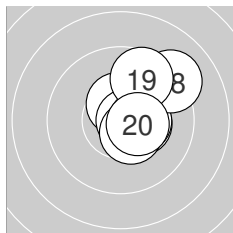

Serie 2: 102.8 (98)

10.4* →	10.6* →	10.5* ↑	10.4* →	10.8* →
10.5* ↘	10.4* →	9.1 ↗	9.6 ↗	10.5* →

beste Teiler: 49.0 (15.), 81.0 (12.), 115.7 (16.)
 Trefferlage: 1.22 mm rechts, 0.52 mm hoch
 Streuwert: 1.17, horizontal: 0.98, vertikal: 1.33

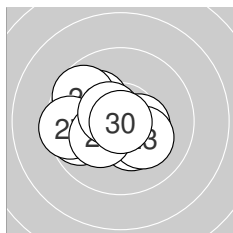

Serie 3: 101.7 (97)

10.4* ↘	10.4* →	10.2* ↘	10.1 ↖	9.7 ←
9.7 ↖	9.5 ←	10.2* ↙	10.6* ↖	10.9* ↓

beste Teiler: 6.0 (30.), 98.4 (29.), 132.4 (22.)
 Trefferlage: 0.94 mm links, 0.15 mm tief
 Streuwert: 1.49, horizontal: 1.81, vertikal: 1.07

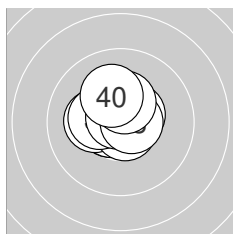

Serie 4: 105.0 (100)

10.6* ←	10.7* ←	10.2* ←	10.7* ↘	10.3* ←
10.8* ↖	10.5* ↗	10.6* →	10.4* ↑	10.2* ↑

beste Teiler: 41.4 (36.), 60.2 (34.), 74.0 (32.)
 Trefferlage: 0.33 mm links, 0.34 mm hoch
 Streuwert: 0.85, horizontal: 0.92, vertikal: 0.76



Ergebnis: 412.6 (396)
Serien: 103.2 102.7 103.8 102.9
Zähler: 36 4 0 0 0 0 0 0 0 0
Innenzehner: 33
Weiteste: 307 (20.), 305 (40.), 296 (12.)
beste Teiler: 61.2 (29.), 64.2 (31.), 78.3 (13.)
Trefferlage: 0.33 mm links, 0.07 mm tief
Streuwert: 1.20, horizontal: 0.93, vertikal: 1.41

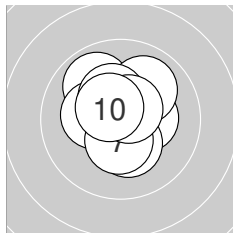
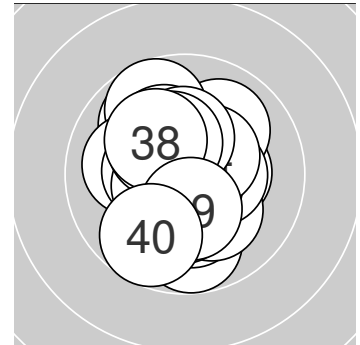

Serie 1: 103.2 (99)

10.3* →	10.6* ↓	9.9 ↘	10.0 ↗	10.3* ↓
10.3* ←	10.4* ↓	10.3* ↗	10.6* ↗	10.5* ↘

beste Teiler: 85.4 (9.), 92.7 (2.), 106.8 (10.)
Trefferlage: 0.04 mm links, 0.34 mm hoch
Streuwert: 1.22, horizontal: 1.12, vertikal: 1.31

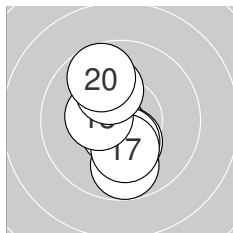

Serie 2: 102.7 (98)

10.5* ↘	9.8 ↓	10.6* ↗	10.4* ↓	10.6* ←
10.4* ↓	10.2* ↓	10.4* ←	10.1 ↗	9.7 ↗

beste Teiler: 78.3 (13.), 92.6 (15.), 119.8 (11.)
Trefferlage: 0.44 mm links, 0.25 mm tief
Streuwert: 1.35, horizontal: 0.74, vertikal: 1.76

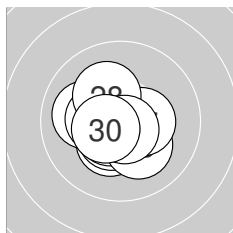

Serie 3: 103.8 (100)

10.3* ↗	10.0 ←	10.4* ←	10.5* ↗	10.6* ↗
10.2* ↘	10.4* →	10.2* ↘	10.7* ↓	10.5* ↗

beste Teiler: 61.2 (29.), 96.8 (25.), 110.0 (30.)
Trefferlage: 0.46 mm links, 0.34 mm tief
Streuwert: 1.04, horizontal: 1.12, vertikal: 0.95

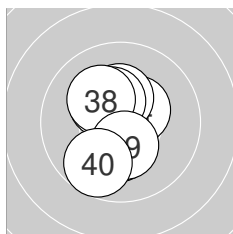

Serie 4: 102.9 (99)

10.7* ↘	10.3* ↓	10.3* ↓	10.4* ↗	10.3* ↑
10.3* ↘	10.4* ↗	10.2* ↘	10.3* ↓	9.7 ↗

beste Teiler: 64.2 (31.), 130.4 (34.), 150.4 (37.)
Trefferlage: 0.38 mm links, 0.04 mm tief
Streuwert: 1.27, horizontal: 0.77, vertikal: 1.62



Ergebnis: 413.6 (395)
Serien: 103.4 103.7 104.3 102.2
Zähler: 35 5 0 0 0 0 0 0 0 0 0
Innenzehner: 30
Weiteste: 443 (36.), 344 (10.), 305 (38.)
beste Teiler: 16.1 (29.), 24.2 (35.), 27.6 (33.)
Trefferlage: 0.28 mm rechts, 0.03 mm hoch
Streuwert: 1.27, horizontal: 1.42, vertikal: 1.11

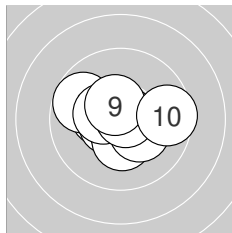
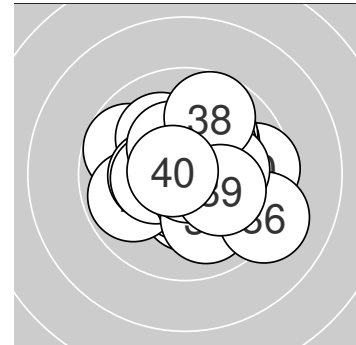

Serie 1: 103.4 (98)

10.4* ←	10.6* ↙	10.8* ↘	10.3* ↓	9.7 ↖
10.4* ←	10.3* ↘	10.8* →	10.5* ↖	9.6 →

beste Teiler: 39.9 (8.), 48.4 (3.), 92.7 (2.)
Trefferlage: 0.18 mm links, 0.02 mm hoch
Streuwert: 1.34, horizontal: 1.70, vertikal: 0.85

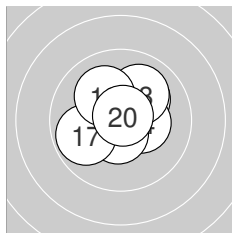

Serie 2: 103.7 (99)

10.7* ↙	10.1 ↗	10.7* ←	10.4* →	10.5* ↖
10.6* ↓	9.8 ↙	10.0 ↗	10.1 ↖	10.8* ↗

beste Teiler: 37.1 (20.), 58.3 (11.), 72.3 (13.)
Trefferlage: 0.14 mm links, 0.39 mm hoch
Streuwert: 1.19, horizontal: 1.29, vertikal: 1.08

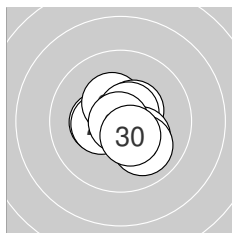

Serie 3: 104.3 (100)

10.3* ←	10.4* ←	10.6* →	10.4* ↖	10.5* ↗
10.6* ↗	10.2* ↘	10.0 ↘	10.9* ↖	10.4* ↘

beste Teiler: 16.1 (29.), 87.7 (26.), 91.6 (23.)
Trefferlage: 0.24 mm rechts, 0.13 mm tief
Streuwert: 1.06, horizontal: 1.13, vertikal: 0.97

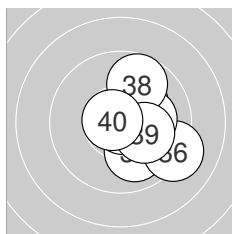

Serie 4: 102.2 (98)

10.2* ↗	10.3* ↘	10.8* ↗	10.0 ↓	10.9* ↘
9.2 ↘	10.2* →	9.7 ↗	10.2* ↘	10.7* ←

beste Teiler: 24.2 (35.), 27.6 (33.), 62.8 (40.)
Trefferlage: 1.20 mm rechts, 0.16 mm tief
Streuwert: 1.38, horizontal: 1.22, vertikal: 1.51



Ergebnis: 409.1 (392)
Serien: 103.1 101.9 103.2 100.9
Zähler: 32 8 0 0 0 0 0 0 0 0 0
Innenzehner: 26
Weiteste: 410 (23.), 375 (14.), 364 (32.)
beste Teiler: 27.2 (6.), 35.8 (22.), 37.0 (30.)
Trefferlage: 0.13 mm links, 0.12 mm tief
Streuwert: 1.47, horizontal: 1.62, vertikal: 1.31

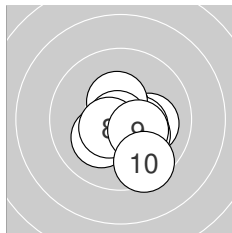
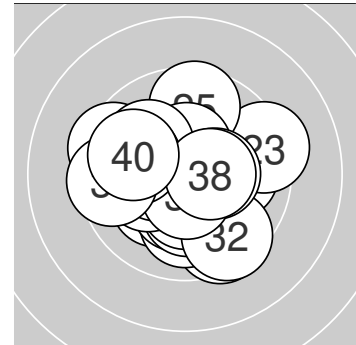

Serie 1: 103.1 (99)

10.1 →	10.2* ↙	10.7* ↑	10.4* →	10.4* ↑
10.8* ↙	10.2* ↘	10.5* ↙	10.3* →	9.5 ↘

beste Teiler: 27.2 (6.), 70.1 (3.), 105.2 (8.)
Trefferlage: 0.49 mm rechts, 0.60 mm tief
Streuwert: 1.20, horizontal: 1.20, vertikal: 1.20

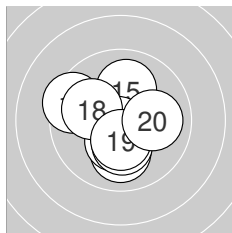

Serie 2: 101.9 (99)

10.0 ↓	10.3* ↓	10.8* ↓	9.5 ↖	10.0 ↑
10.2* ↓	10.7* ↓	10.0 ↖	10.4* ↓	10.0 →

beste Teiler: 48.0 (13.), 52.9 (17.), 146.0 (19.)
Trefferlage: 0.32 mm links, 0.37 mm tief
Streuwert: 1.52, horizontal: 1.56, vertikal: 1.48

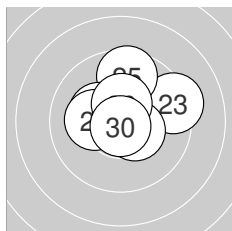

Serie 3: 103.2 (98)

10.6* ↑	10.8* ↖	9.3 →	10.8* ←	9.6 ↑
10.3* ↖	10.4* ↘	10.2* ←	10.4* ↑	10.8* ↓

beste Teiler: 35.8 (22.), 37.0 (30.), 41.0 (24.)
Trefferlage: 0.13 mm rechts, 0.66 mm hoch
Streuwert: 1.38, horizontal: 1.59, vertikal: 1.14

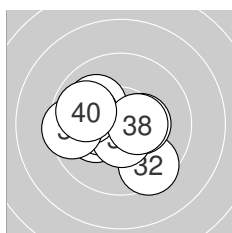

Serie 4: 100.9 (96)

10.2* ↙	9.5 ↘	10.4* →	10.4* ←	10.6* ↓
10.0 ↖	9.9 ↖	10.5* →	9.5 ←	9.9 ↖

beste Teiler: 96.4 (35.), 125.0 (38.), 138.1 (34.)
Trefferlage: 0.86 mm links, 0.18 mm tief
Streuwert: 1.63, horizontal: 1.95, vertikal: 1.22



Ergebnis: **416.5** (397)
 Serien: 104.6 103.4 103.8 104.7
 Zähler: 37 3 0 0 0 0 0 0 0 0
 Innenzehner: 31
 Weitester: 374 (22.), 347 (14.), 282 (13.)
 beste Teiler: 19.6 (36.), 37.5 (11.), 39.4 (30.)
 Trefferlage: 0.14 mm rechts, 0.23 mm hoch
 Streuwert: 1.13, horizontal: 1.05, vertikal: 1.19

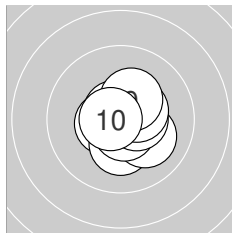
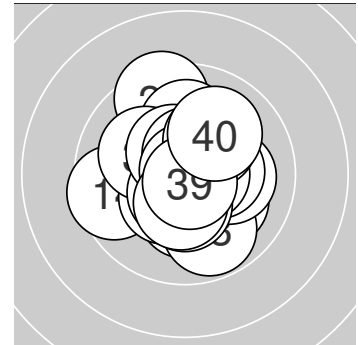

Serie 1: 104.6 (100)

10.5* ↗	10.5* ←	10.3* ↓	10.1 ↘	10.6* ↓
10.7* ↘	10.5* →	10.4* ↗	10.3* ↑	10.7* ←

beste Teiler: 66.2 (6.), 71.0 (10.), 77.4 (5.)
 Trefferlage: 0.39 mm rechts, 0.08 mm tief
 Streuwert: 0.93, horizontal: 0.92, vertikal: 0.95

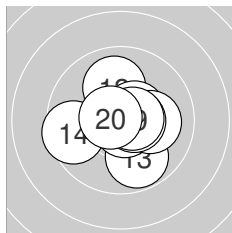

Serie 2: 103.4 (98)

10.8* ↘	10.0 ↑	9.8 ↓	9.6 ←	10.5* ↗
10.7* ↘	10.1 →	10.6* →	10.6* →	10.7* ←

beste Teiler: 37.5 (11.), 51.0 (16.), 74.4 (20.)
 Trefferlage: 0.15 mm rechts, 0.06 mm tief
 Streuwert: 1.37, horizontal: 1.50, vertikal: 1.22

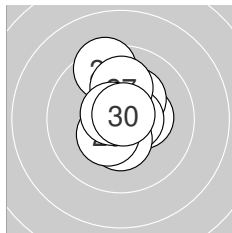

Serie 3: 103.8 (99)

10.3* →	9.5 ↑	10.3* ↗	10.7* ←	10.6* →
10.4* ↓	10.1 ↑	10.4* ↗	10.7* ↘	10.8* ↗

beste Teiler: 39.4 (30.), 60.4 (24.), 74.0 (29.)
 Trefferlage: 0.04 mm rechts, 0.57 mm hoch
 Streuwert: 1.23, horizontal: 0.87, vertikal: 1.50

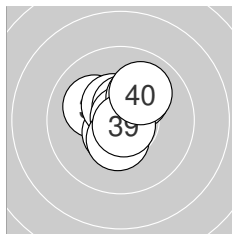

Serie 4: 104.7 (100)

10.6* ↑	10.1 ↘	10.6* ↗	10.5* ↘	10.6* ↑
10.9* ↗	10.4* ↓	10.2* ↗	10.8* ↘	10.0 ↗

beste Teiler: 19.6 (36.), 43.5 (39.), 89.0 (31.)
 Trefferlage: 0.00 mm, 0.49 mm hoch
 Streuwert: 1.00, horizontal: 0.92, vertikal: 1.07



Ergebnis: 414.4 (394)
Serien: 102.8 103.9 104.0 103.7
Zähler: 34 6 0 0 0 0 0 0 0 0 0
Innenzehner: 30
Weiteste: 351 (40.), 302 (2.), 278 (9.)
beste Teiler: 22.2 (31.), 38.9 (16.), 39.6 (22.)
Trefferlage: 0.11 mm links, 0.49 mm hoch
Streuwert: 1.16, horizontal: 1.37, vertikal: 0.88

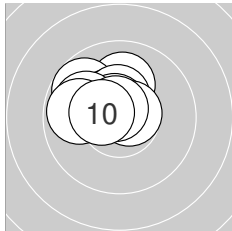
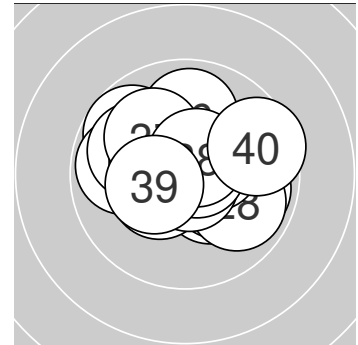

Serie 1: 102.8 (98)

10.1 ↑	9.7 ↘	10.4* ↘	10.4* ↑	10.6* ↘
10.7* →	10.0 ↖	10.7* ↘	9.8 ←	10.4* ↘

beste Teiler: 65.3 (8.), 71.3 (6.), 82.7 (5.)
Trefferlage: 0.93 mm links, 0.97 mm hoch
Streuwert: 0.96, horizontal: 1.19, vertikal: 0.66

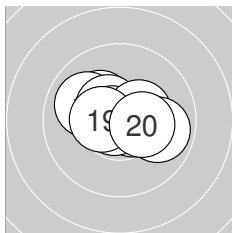

Serie 2: 103.9 (99)

10.6* →	10.2* ↘	10.0 ↖	10.5* ↘	10.7* ←
10.8* ↖	10.4* →	9.9 →	10.5* ←	10.3* →

beste Teiler: 38.9 (16.), 53.1 (15.), 94.9 (11.)
Trefferlage: 0.00 mm, 0.24 mm hoch
Streuwert: 1.17, horizontal: 1.52, vertikal: 0.63

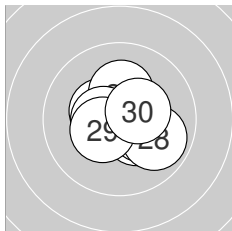

Serie 3: 104.0 (99)

10.7* ↘	10.8* →	10.4* ↖	10.4* ↘	10.2* ↑
10.3* →	10.5* ←	9.9 →	10.4* ↖	10.4* →

beste Teiler: 39.6 (22.), 74.7 (21.), 111.0 (27.)
Trefferlage: 0.29 mm rechts, 0.01 mm tief
Streuwert: 1.11, horizontal: 1.27, vertikal: 0.93

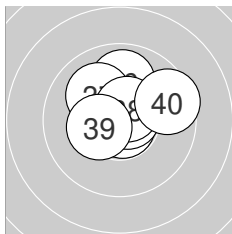

Serie 4: 103.7 (98)

10.9* ↓	10.8* ↘	10.3* ↗	10.7* →	10.5* ↘
9.9 ↑	10.1 ↘	10.6* ↗	10.4* ←	9.5 →

beste Teiler: 22.2 (31.), 42.5 (32.), 60.4 (34.)
Trefferlage: 0.17 mm rechts, 0.76 mm hoch
Streuwert: 1.18, horizontal: 1.35, vertikal: 0.99



Ergebnis: **410.5** (393)
 Serien: 100.4 103.8 103.6 102.7
 Zähler: 35 3 2 0 0 0 0 0 0 0
 Innenzehner: 28
 Weitester: 669 (10.), 577 (9.), 343 (17.)
 beste Teiler: 9.0 (29.), 28.0 (8.), 29.2 (16.)
 Trefferlage: 0.27 mm links, 0.02 mm hoch
 Streuwert: 1.53, horizontal: 1.84, vertikal: 1.13

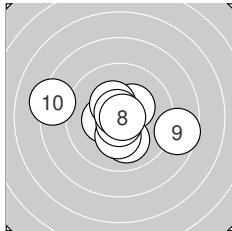
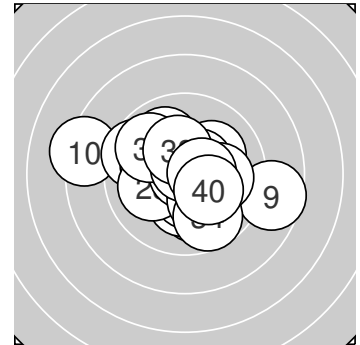

Serie 1: 100.4 (96)

10.4* ←	10.3* ↗	10.4* ↘	10.0 ↓	10.2* ↓
10.7* ↓	10.7* ↘	10.8* →	8.6 →	8.3 ←

beste Teiler: 28.0 (8.), 51.0 (7.), 60.2 (6.)
 Trefferlage: 0.13 mm links, 0.20 mm tief
 Streuwert: 2.28, horizontal: 2.95, vertikal: 1.29

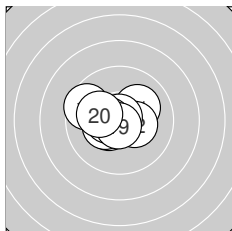

Serie 2: 103.8 (99)

10.1 ↗	10.4* →	10.5* ↖	10.3* ←	10.8* ↖
10.8* ↑	9.6 ↖	10.5* ←	10.7* ↓	10.1 ↖

beste Teiler: 29.2 (16.), 49.2 (15.), 55.5 (19.)
 Trefferlage: 0.60 mm links, 0.08 mm hoch
 Streuwert: 1.17, horizontal: 1.48, vertikal: 0.74

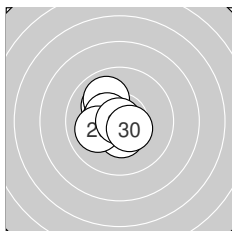

Serie 3: 103.6 (100)

10.2* ↘	10.1 ↘	10.0 ↘	10.6* ←	10.4* ←
10.4* ↓	10.4* ↖	10.1 ←	10.9* ←	10.5* ↘

beste Teiler: 9.0 (29.), 83.9 (24.), 119.4 (30.)
 Trefferlage: 0.86 mm links, 0.24 mm hoch
 Streuwert: 1.02, horizontal: 0.94, vertikal: 1.09

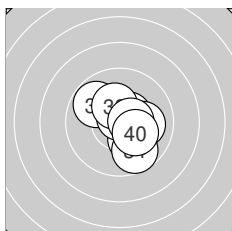

Serie 4: 102.7 (98)

10.5* ↗	10.6* ↑	10.2* ↘	9.7 ↓	9.8 ↘
10.8* ↑	10.1 →	10.3* ↑	10.5* →	10.2* ↘

beste Teiler: 45.0 (36.), 94.5 (32.), 109.3 (39.)
 Trefferlage: 0.52 mm rechts, 0.02 mm tief
 Streuwert: 1.36, horizontal: 1.30, vertikal: 1.42



Ergebnis: **416.7** (396)
 Serien: 104.2 103.2 104.3 105.0
 Zähler: 36 4 0 0 0 0 0 0 0 0
 Innenzehner: 31
 Weitestе: 349 (15.), 340 (19.), 321 (8.)
 beste Teiler: 21.4 (18.), 30.0 (36.), 30.4 (7.)
 Trefferlage: 0.28 mm links, 0.07 mm hoch
 Streuwert: 1.13, horizontal: 1.21, vertikal: 1.04

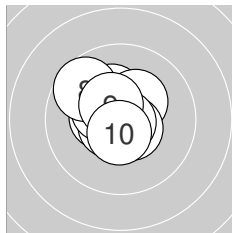
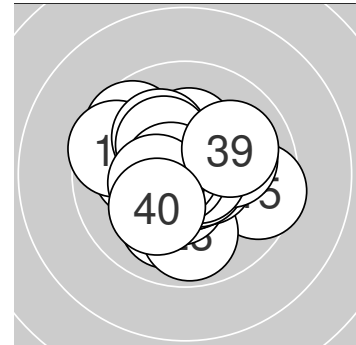

Serie 1: 104.2 (99)

10.3* ↖	10.4* ←	10.3* ↗	10.6* ↙	10.6* ↘
10.4* ↖	10.8* ↘	9.7 ↖	10.5* ↖	10.6* ↓

beste Teiler: 30.4 (7.), 85.7 (4.), 94.5 (10.)
 Trefferlage: 0.51 mm links, 0.45 mm hoch
 Streuwert: 1.03, horizontal: 1.04, vertikal: 1.02

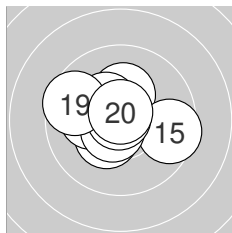

Serie 2: 103.2 (98)

10.4* ↗	10.2* ↑	10.1 ←	10.7* ↖	9.6 →
10.4* ↖	10.6* ↗	10.9* ↖	9.6 ↖	10.7* ↑

beste Teiler: 21.4 (18.), 58.0 (20.), 64.2 (14.)
 Trefferlage: 0.49 mm links, 0.26 mm hoch
 Streuwert: 1.37, horizontal: 1.71, vertikal: 0.93

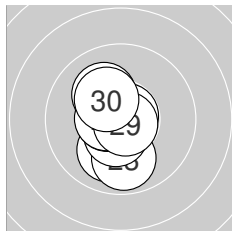

Serie 3: 104.3 (99)

10.7* ↓	10.0 ↓	9.9 ↓	10.1 ↖	10.5* ↓
10.6* ←	10.6* ←	10.8* ↗	10.8* ↘	10.3* ↖

beste Teiler: 46.3 (28.), 46.6 (29.), 53.0 (21.)
 Trefferlage: 0.42 mm links, 0.33 mm tief
 Streuwert: 1.07, horizontal: 0.61, vertikal: 1.38

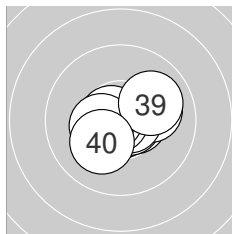

Serie 4: 105.0 (100)

10.6* →	10.8* ↓	10.7* ↘	10.1 →	10.7* →
10.8* ←	10.7* ←	10.4* ←	10.0 ↗	10.2* ↗

beste Teiler: 30.0 (36.), 41.3 (32.), 62.1 (35.)
 Trefferlage: 0.28 mm rechts, 0.06 mm tief
 Streuwert: 1.00, horizontal: 1.23, vertikal: 0.71



Ergebnis: 410.5 (389)
Serien: 102.2 101.5 102.9 103.9
Zähler: 29 11 0 0 0 0 0 0 0 0
Innenzehner: 26
Weiteste: 382 (29.), 320 (7.), 319 (13.)
beste Teiler: 35.7 (8.), 47.0 (33.), 53.8 (35.)
Trefferlage: 0.40 mm links, 0.60 mm hoch
Streuwert: 1.32, horizontal: 1.42, vertikal: 1.22

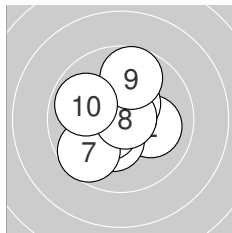
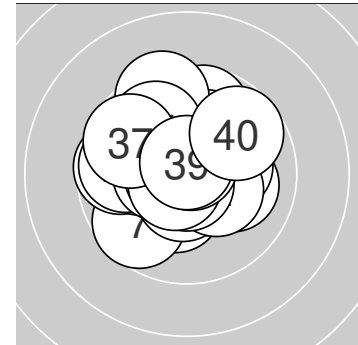

Serie 1: 102.2 (97)

10.5* ↑	10.1 →	10.3* ←	10.4* ↗	10.3* ↓
10.5* ↙	9.7 ↘	10.8* →	9.7 ↑	9.9 ↖

beste Teiler: 35.7 (8.), 105.0 (1.), 120.6 (6.)
Trefferlage: 0.41 mm links, 0.13 mm hoch
Streuwert: 1.49, horizontal: 1.48, vertikal: 1.50

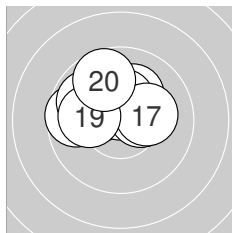

Serie 2: 101.5 (97)

10.3* ↖	10.2* ↗	9.7 ←	10.6* ↑	10.4* ↑
10.4* →	10.2* →	9.9 ↖	10.1 ←	9.7 ↗

beste Teiler: 83.1 (14.), 143.1 (15.), 146.1 (16.)
Trefferlage: 0.60 mm links, 1.03 mm hoch
Streuwert: 1.35, horizontal: 1.72, vertikal: 0.84

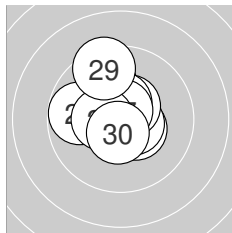

Serie 3: 102.9 (98)

10.4* ↘	10.0 ↖	10.6* →	10.5* ↗	9.8 ←
10.5* ↑	10.7* ↑	10.4* ←	9.4 ↖	10.6* ↓

beste Teiler: 63.2 (27.), 94.5 (23.), 99.0 (30.)
Trefferlage: 0.39 mm links, 0.70 mm hoch
Streuwert: 1.31, horizontal: 1.22, vertikal: 1.40

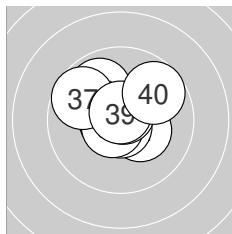

Serie 4: 103.9 (97)

10.3* ↘	10.7* ←	10.8* ↓	9.9 ↖	10.7* ↖
10.7* ↙	9.7 ↖	10.7* ↑	10.7* ↑	9.7 ↗

beste Teiler: 47.0 (33.), 53.8 (35.), 55.0 (39.)
Trefferlage: 0.19 mm links, 0.54 mm hoch
Streuwert: 1.24, horizontal: 1.41, vertikal: 1.04



Ergebnis: 410.7 (389)
Serien: 103.8 103.0 101.9 102.0
Zähler: 30 9 1 0 0 0 0 0 0 0
Innenzehner: 27
Weiteste: 507 (29.), 433 (40.), 377 (21.)
beste Teiler: 20.8 (1.), 23.0 (25.), 23.6 (11.)
Trefferlage: 0.47 mm rechts, 0.49 mm tief
Streuwert: 1.40, horizontal: 1.41, vertikal: 1.39

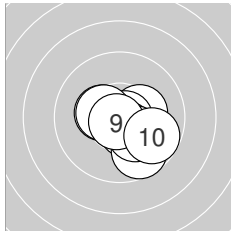
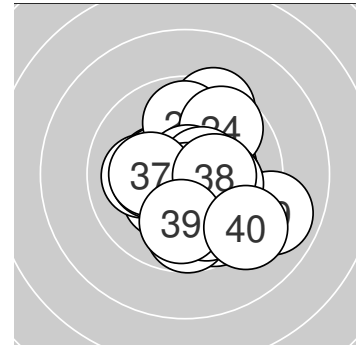

Serie 1: 103.8 (98)

10.9* ↓	10.4* ←	10.3* →	10.8* →	10.5* ↓
9.7 ↓	10.2* ↓	10.4* ←	10.8* ↗	9.8 ↘

beste Teiler: 20.8 (1.), 43.8 (9.), 44.6 (4.)
Trefferlage: 0.50 mm rechts, 0.61 mm tief
Streuwert: 1.16, horizontal: 1.29, vertikal: 1.00

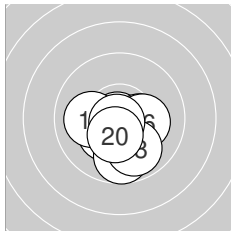

Serie 2: 103.0 (98)

10.9* ↙	10.3* ↗	10.3* →	9.7 ↓	10.4* ↘
10.2* →	10.1 ←	9.9 ↓	10.8* ↗	10.4* ↓

beste Teiler: 23.6 (11.), 39.4 (19.), 137.7 (20.)
Trefferlage: 0.15 mm rechts, 1.01 mm tief
Streuwert: 1.14, horizontal: 1.26, vertikal: 1.02

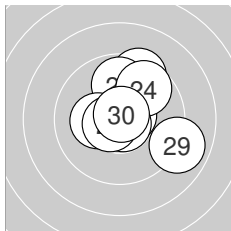

Serie 3: 101.9 (95)

9.4 ↑	9.9 ↑	10.6* →	9.7 ↗	10.9* ↑
10.8* ↓	10.3* ←	10.6* ←	8.9 →	10.8* ↑

beste Teiler: 23.0 (25.), 41.4 (30.), 47.0 (26.)
Trefferlage: 0.66 mm rechts, 0.66 mm hoch
Streuwert: 1.72, horizontal: 1.74, vertikal: 1.70

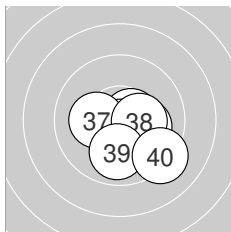

Serie 4: 102.0 (98)

10.6* ↙	10.1 ↓	10.3* ↓	10.6* →	10.1 →
10.7* ↓	10.2* ←	10.3* →	9.9 ↓	9.2 ↓

beste Teiler: 57.0 (36.), 90.8 (31.), 95.5 (34.)
Trefferlage: 0.56 mm rechts, 1.03 mm tief
Streuwert: 1.31, horizontal: 1.47, vertikal: 1.13



Ergebnis: 413.2 (393)
Serien: 105.7 105.0 99.0 103.5
Zähler: 33 7 0 0 0 0 0 0 0 0
Innenzehner: 28
Weiteste: 385 (23.), 377 (24.), 341 (28.)
beste Teiler: 15.1 (31.), 23.0 (1.), 25.5 (16.)
Trefferlage: 0.62 mm rechts, 0.27 mm hoch
Streuwert: 1.24, horizontal: 1.51, vertikal: 0.88

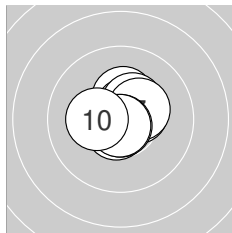
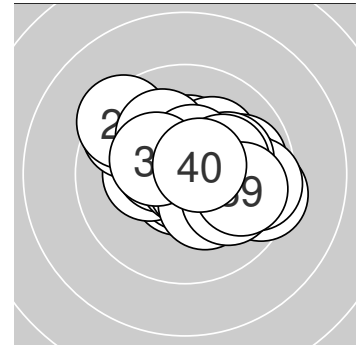

Serie 1: 105.7 (100)

10.9* ↘	10.5* →	10.3* ↑	10.6* ↗	10.4* ↗
10.7* ↙	10.4* ↗	10.8* ↓	10.8* ↓	10.3* ←

beste Teiler: 23.0 (1.), 46.6 (9.), 47.0 (8.)
Trefferlage: 0.17 mm rechts, 0.31 mm hoch
Streuwert: 0.80, horizontal: 0.86, vertikal: 0.73

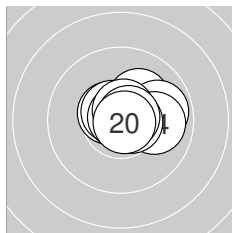

Serie 2: 105.0 (99)

10.2* ↗	9.9 →	10.6* ↘	10.0 →	10.6* ↘
10.9* ↘	10.7* ↑	10.6* →	10.7* →	10.8* ↘

beste Teiler: 25.5 (16.), 30.8 (20.), 61.8 (19.)
Trefferlage: 0.66 mm rechts, 0.39 mm hoch
Streuwert: 0.90, horizontal: 1.17, vertikal: 0.51

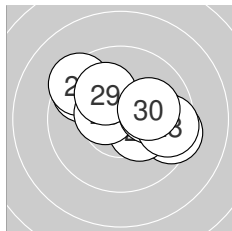

Serie 3: 99.0 (95)

9.9 →	9.6 ↘	9.4 ↘	9.4 →	10.3* ↘
10.5* ←	10.1 →	9.6 →	10.1 ↘	10.1 →

beste Teiler: 117.7 (26.), 156.2 (25.), 212.4 (29.)
Trefferlage: 0.72 mm rechts, 0.58 mm hoch
Streuwert: 1.94, horizontal: 2.46, vertikal: 1.20

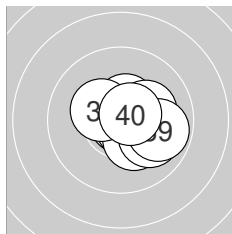

Serie 4: 103.5 (99)

10.9* ↓	10.2* ↘	10.7* ↘	10.3* ↓	10.5* ↑
10.2* →	10.3* ↘	10.0 ↘	9.8 →	10.6* ↗

beste Teiler: 15.1 (31.), 65.0 (33.), 82.1 (40.)
Trefferlage: 0.92 mm rechts, 0.18 mm tief
Streuwert: 1.03, horizontal: 1.17, vertikal: 0.86



Ergebnis: **416.5** (397)
 Serien: 104.4 103.6 103.9 104.6
 Zähler: 37 3 0 0 0 0 0 0 0 0 0
 Innenzehner: 33
 Weitester: 375 (17.), 323 (13.), 282 (8.)
 beste Teiler: 8.9 (36.), 13.0 (23.), 14.3 (7.)
 Trefferlage: 0.67 mm links, 0.26 mm tief
 Streuwert: 1.00, horizontal: 1.00, vertikal: 1.01

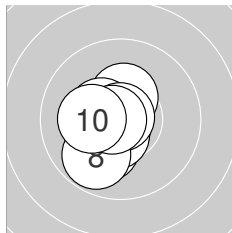
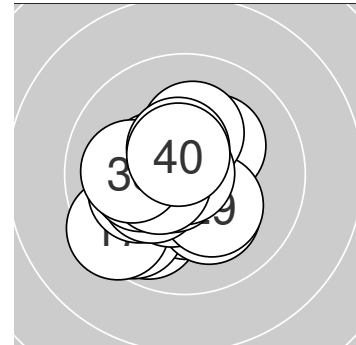

Serie 1: 104.4 (99)

10.4* ↑	10.8* ←	10.4* ←	10.1 ↘	10.6* ↘
10.5* ↘	10.9* ↑	9.8 ↘	10.7* ←	10.2* ←

beste Teiler: 14.3 (7.), 44.3 (2.), 55.0 (9.)
 Trefferlage: 0.71 mm links, 0.40 mm tief
 Streuwert: 0.92, horizontal: 0.68, vertikal: 1.11

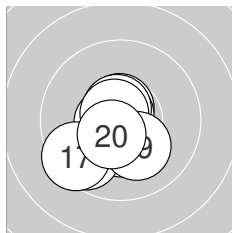

Serie 2: 103.6 (98)

10.6* ↑	10.4* ↓	9.7 ↘	10.8* ↑	10.6* ↑
10.6* ←	9.5 ↘	10.7* ↘	10.2* ↘	10.5* ↘

beste Teiler: 36.6 (14.), 60.1 (18.), 77.7 (15.)
 Trefferlage: 0.62 mm links, 0.65 mm tief
 Streuwert: 1.20, horizontal: 1.16, vertikal: 1.25

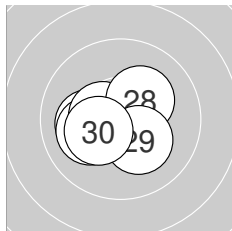

Serie 3: 103.9 (100)

10.3* ←	10.1 ←	10.9* ↑	10.9* ↑	10.4* ↘
10.1 ←	10.5* ←	10.2* ↗	10.2* ↘	10.3* ↘

beste Teiler: 13.0 (23.), 14.5 (24.), 117.8 (27.)
 Trefferlage: 0.50 mm links, 0.27 mm tief
 Streuwert: 1.07, horizontal: 1.32, vertikal: 0.74

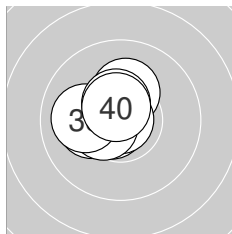

Serie 4: 104.6 (100)

10.5* ←	10.2* ←	10.5* ←	10.2* ↑	10.7* ←
10.9* ↘	10.5* ←	10.0 ←	10.5* ↑	10.6* ↑

beste Teiler: 8.9 (36.), 66.1 (35.), 89.8 (40.)
 Trefferlage: 0.85 mm links, 0.29 mm hoch
 Streuwert: 0.78, horizontal: 0.83, vertikal: 0.72



Ergebnis: 408.9 (392)
Serien: 103.1 102.0 101.5 102.3
Zähler: 32 8 0 0 0 0 0 0 0 0 0
Innenzehner: 25
Weiteste: 340 (2.), 316 (30.), 303 (18.)
beste Teiler: 31.0 (36.), 63.4 (8.), 75.6 (4.)
Trefferlage: 0.77 mm links, 0.03 mm tief
Streuwert: 1.29, horizontal: 1.27, vertikal: 1.31

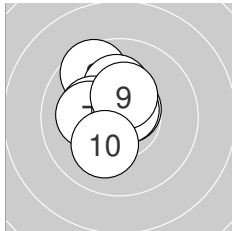
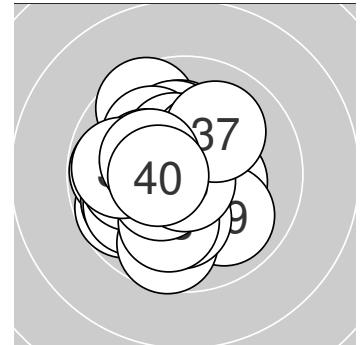

Serie 1: 103.1 (99)

10.6* ←	9.6 ↘	10.5* ←	10.7* ↗	10.2* ↑
10.2* ←	10.1 ←	10.7* ↗	10.4* ↑	10.1 ↘

beste Teiler: 63.4 (8.), 75.6 (4.), 76.1 (1.)
Trefferlage: 0.73 mm links, 0.61 mm hoch
Streuwert: 1.12, horizontal: 0.94, vertikal: 1.28

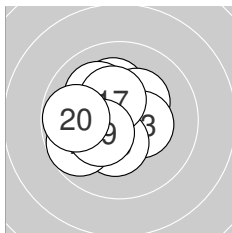

Serie 2: 102.0 (98)

10.2* ↑	10.3* ↗	10.4* →	10.4* ↖	10.3* ↓
10.1 ↘	10.4* ↑	9.7 ↙	10.4* ↙	9.8 ←

beste Teiler: 139.8 (13.), 144.8 (17.), 145.4 (14.)
Trefferlage: 0.83 mm links, 0.28 mm hoch
Streuwert: 1.34, horizontal: 1.40, vertikal: 1.27

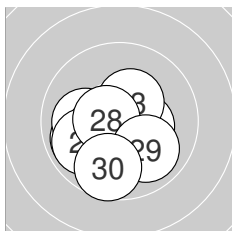

Serie 3: 101.5 (96)

10.3* ↘	10.4* →	10.4* ↗	9.9 ↙	10.0 ←
10.4* ↙	9.9 ↙	10.6* ←	9.9 ↘	9.7 ↓

beste Teiler: 88.9 (28.), 144.2 (23.), 146.0 (22.)
Trefferlage: 0.51 mm links, 0.82 mm tief
Streuwert: 1.41, horizontal: 1.60, vertikal: 1.19

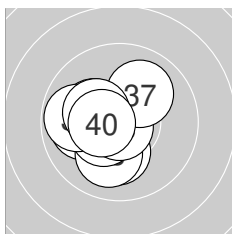

Serie 4: 102.3 (99)

10.2* ↓	10.0 ←	10.1 ↓	10.2* ↖	10.4* ↙
10.8* ↓	10.0 ↗	9.8 ←	10.3* ↖	10.5* ←

beste Teiler: 31.0 (36.), 119.2 (40.), 127.5 (35.)
Trefferlage: 1.02 mm links, 0.19 mm tief
Streuwert: 1.21, horizontal: 1.22, vertikal: 1.20



Ergebnis: 410.0 (391)
Serien: 102.4 104.9 102.0 100.7
Zähler: 32 7 1 0 0 0 0 0 0 0
Innenzehner: 24
Weiteste: 572 (32.), 343 (2.), 328 (22.)
beste Teiler: 3.1 (18.), 43.2 (1.), 46.9 (24.)
Trefferlage: 0.50 mm rechts, 0.02 mm hoch
Streuwert: 1.41, horizontal: 1.56, vertikal: 1.25

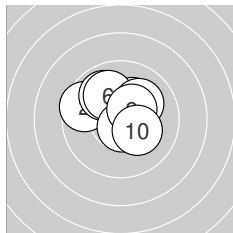
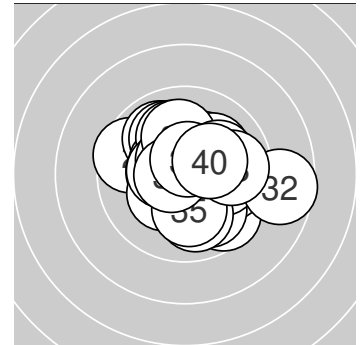

Serie 1: 102.4 (98)

10.8* ↗	9.6 ↖	10.5* →	9.9 ↘	10.2* ↗
10.0 ↘	10.1 ↗	10.7* ↓	10.4* ↗	10.2* ↘

beste Teiler: 43.2 (1.), 70.4 (8.), 123.9 (3.)
Trefferlage: 0.10 mm rechts, 0.79 mm hoch
Streuwert: 1.35, horizontal: 1.58, vertikal: 1.08

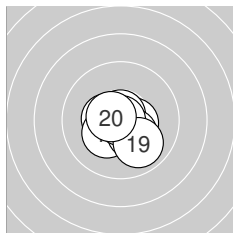

Serie 2: 104.9 (99)

10.6* ↓	10.4* ←	10.5* →	10.6* ←	10.8* ↑
10.3* ↗	10.3* ↘	10.9* ↓	9.9 ↘	10.6* ↖

beste Teiler: 3.1 (18.), 47.0 (15.), 76.0 (14.)
Trefferlage: 0.00 mm, 0.49 mm tief
Streuwert: 0.91, horizontal: 1.02, vertikal: 0.79

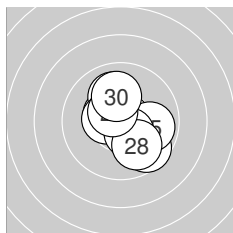

Serie 3: 102.0 (97)

10.4* ↖	9.6 ↘	10.0 ↑	10.8* ↗	9.9 →
10.4* ←	10.4* ↘	9.9 ↘	10.5* ↘	10.1 ↑

beste Teiler: 46.9 (24.), 110.7 (29.), 126.5 (26.)
Trefferlage: 0.34 mm rechts, 0.02 mm hoch
Streuwert: 1.49, horizontal: 1.41, vertikal: 1.57

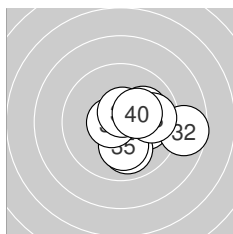

Serie 4: 100.7 (97)

10.1 →	8.7 →	10.4* →	10.0 ↓	10.1 ↓
10.6* ←	10.1 ↗	9.8 →	10.6* ↑	10.3* ↗

beste Teiler: 81.0 (36.), 90.4 (39.), 139.5 (33.)
Trefferlage: 1.57 mm rechts, 0.21 mm tief
Streuwert: 1.53, horizontal: 1.80, vertikal: 1.20



Ergebnis: **407.2** (388)
 Serien: 100.9 101.6 101.7 103.0
 Zähler: 28 12 0 0 0 0 0 0 0 0
 Innenzehner: 23
 Weitestе: 392 (22.), 385 (25.), 335 (5.)
 beste Teiler: 50.2 (38.), 51.8 (4.), 57.3 (37.)
 Trefferlage: 0.56 mm links, 0.21 mm tief
 Streuwert: 1.48, horizontal: 1.79, vertikal: 1.09

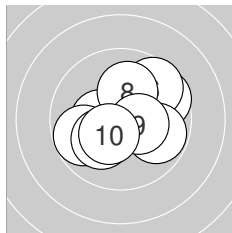
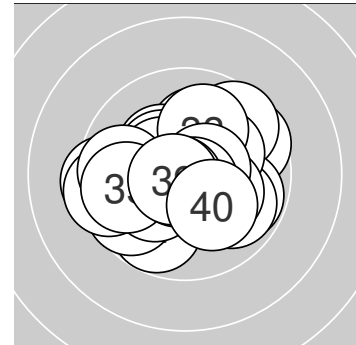

Serie 1: 100.9 (96)

10.4* ←	9.8 ↙	10.1 ↘	10.7* →	9.6 ↗
9.6 ↗	9.8 ↘	10.1 ↑	10.4* →	10.4* ↘

beste Teiler: 51.8 (4.), 138.4 (9.), 139.6 (10.)
 Trefferlage: 0.38 mm rechts, 0.04 mm hoch
 Streuwert: 1.71, horizontal: 1.97, vertikal: 1.41

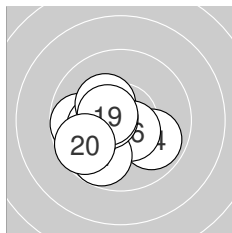

Serie 2: 101.6 (96)

9.8 ←	10.2* ←	10.3* ↘	9.9 ↘	10.3* ↘
10.5* ↘	9.8 ↘	10.6* ←	10.5* ↘	9.7 ↘

beste Teiler: 96.6 (18.), 104.1 (19.), 106.2 (16.)
 Trefferlage: 0.98 mm links, 0.69 mm tief
 Streuwert: 1.35, horizontal: 1.53, vertikal: 1.13

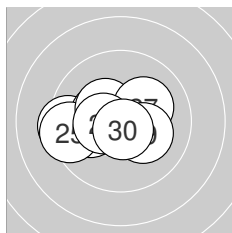

Serie 3: 101.7 (98)

10.0 ←	9.4 ←	10.7* ←	10.3* ←	9.4 ←
10.4* ↘	10.2* ↗	10.4* ←	10.2* →	10.7* ↓

beste Teiler: 63.6 (30.), 64.3 (23.), 129.1 (28.)
 Trefferlage: 1.08 mm links, 0.09 mm tief
 Streuwert: 1.45, horizontal: 1.93, vertikal: 0.69

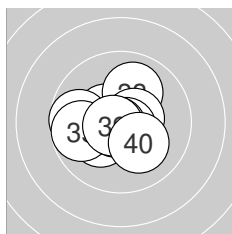

Serie 4: 103.0 (98)

10.5* ↘	9.7 ←	10.0 ↑	10.2* ↘	9.8 ←
10.5* →	10.7* ↘	10.8* ↘	10.7* ←	10.1 ↘

beste Teiler: 50.2 (38.), 57.3 (37.), 62.6 (39.)
 Trefferlage: 0.58 mm links, 0.11 mm tief
 Streuwert: 1.32, horizontal: 1.56, vertikal: 1.03



Ergebnis: 416.5 (395)
Serien: 104.2 102.7 103.9 105.7
Zähler: 35 5 0 0 0 0 0 0 0 0
Innenzehner: 30
Weiteste: 320 (11.), 293 (6.), 287 (30.)
beste Teiler: 13.0 (1.), 20.6 (27.), 28.2 (26.)
Trefferlage: 0.37 mm links, 0.30 mm hoch
Streuwert: 1.10, horizontal: 1.31, vertikal: 0.83

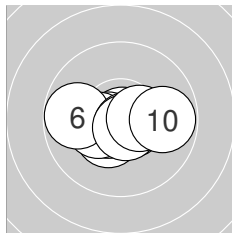
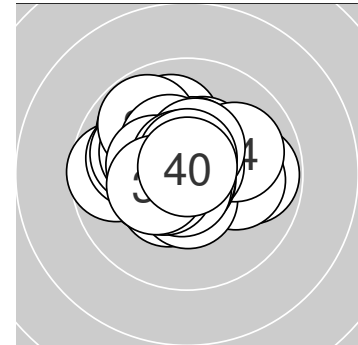

Serie 1: 104.2 (98)

10.9* ↘	10.6* ↘	10.4* ↗	10.6* ←	10.3* ←
9.8 ←	10.7* ↘	10.7* ↘	10.4* →	9.8 →

beste Teiler: 13.0 (1.), 58.6 (7.), 65.5 (8.)
Trefferlage: 0.03 mm links, 0.29 mm tief
Streuwert: 1.15, horizontal: 1.59, vertikal: 0.36

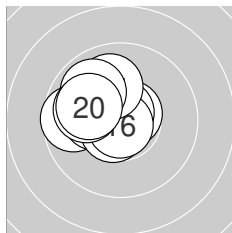

Serie 2: 102.7 (98)

9.7 ←	10.7* ↗	10.7* ↑	10.3* ←	10.6* ↗
10.8* ↓	10.0 ↑	9.9 ↘	10.0 ←	10.0 ↘

beste Teiler: 32.2 (16.), 52.0 (13.), 73.4 (12.)
Trefferlage: 1.19 mm links, 0.61 mm hoch
Streuwert: 1.08, horizontal: 1.23, vertikal: 0.90

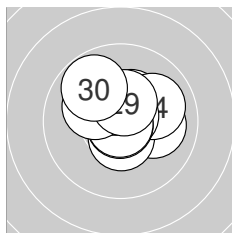

Serie 3: 103.9 (99)

10.1 →	10.5* ↓	10.4* ↗	10.0 →	10.8* ↗
10.8* ↓	10.9* ↓	10.2* ↖	10.4* ↑	9.8 ↘

beste Teiler: 20.6 (27.), 28.2 (26.), 50.2 (25.)
Trefferlage: 0.20 mm rechts, 0.52 mm hoch
Streuwert: 1.18, horizontal: 1.33, vertikal: 1.00

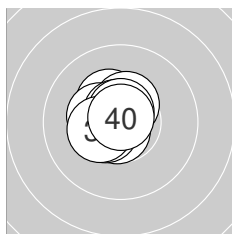

Serie 4: 105.7 (100)

10.7* ↙	10.3* ↘	10.7* ↑	10.5* ↑	10.4* ←
10.7* ↘	10.7* ↑	10.5* ←	10.4* ←	10.8* ↑

beste Teiler: 33.0 (40.), 57.0 (33.), 62.3 (31.)
Trefferlage: 0.47 mm links, 0.36 mm hoch
Streuwert: 0.66, horizontal: 0.64, vertikal: 0.69



Ergebnis: **415.0** (398)
 Serien: 103.2 104.7 104.0 103.1
 Zähler: 38 2 0 0 0 0 0 0 0 0
 Innenzehner: 32
 Weitesten: 466 (22.), 425 (40.), 244 (8.)
 beste Teiler: 45.3 (38.), 50.6 (2.), 53.0 (21.)
 Trefferlage: 0.10 mm rechts, 0.22 mm tief
 Streuwert: 1.22, horizontal: 1.54, vertikal: 0.79

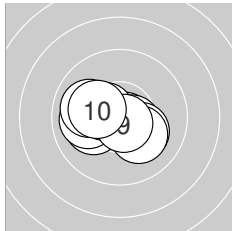
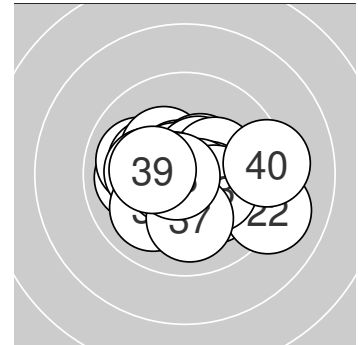

Serie 1: 103.2 (100)

10.1 ←	10.8* ↘	10.0 ←	10.5* ↘	10.2* ↘
10.2* ↘	10.5* ←	10.0 ←	10.7* ↘	10.2* ←

beste Teiler: 50.6 (2.), 56.8 (9.), 106.5 (4.)
 Trefferlage: 0.49 mm links, 0.28 mm tief
 Streuwert: 1.24, horizontal: 1.61, vertikal: 0.69

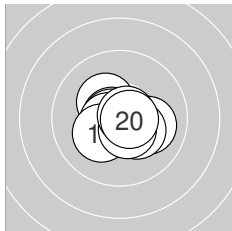

Serie 2: 104.7 (100)

10.3* ↘	10.7* ←	10.7* ←	10.1 →	10.6* ←
10.3* ↘	10.2* ↗	10.5* ↘	10.7* →	10.6* →

beste Teiler: 56.8 (19.), 63.0 (13.), 63.7 (12.)
 Trefferlage: 0.07 mm rechts, 0.22 mm tief
 Streuwert: 0.97, horizontal: 1.17, vertikal: 0.70

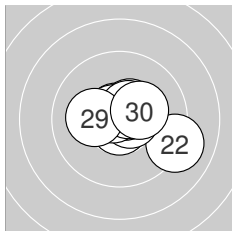

Serie 3: 104.0 (99)

10.7* ↓	9.1 ↘	10.6* →	10.6* ↗	10.7* ↘
10.5* ↗	10.7* ↘	10.6* ↗	10.2* ←	10.3* ↗

beste Teiler: 53.0 (21.), 62.2 (25.), 64.6 (27.)
 Trefferlage: 0.57 mm rechts, 0.16 mm hoch
 Streuwert: 1.28, horizontal: 1.61, vertikal: 0.82

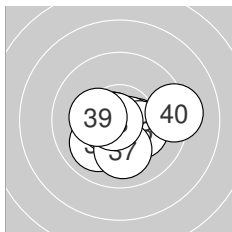

Serie 4: 103.1 (99)

10.4* ↘	10.7* ↘	10.3* ↘	10.0 ↗	10.6* ←
10.7* ←	10.0 ↓	10.8* ←	10.3* ←	9.3 →

beste Teiler: 45.3 (38.), 65.2 (36.), 72.6 (32.)
 Trefferlage: 0.25 mm rechts, 0.54 mm tief
 Streuwert: 1.39, horizontal: 1.76, vertikal: 0.87



Ergebnis: **417.2** (393)
 Serien: 105.0 105.2 102.8 104.2
 Zähler: 33 7 0 0 0 0 0 0 0 0
 Innenzehner: 30
 Weitester: 328 (28.), 290 (1.), 282 (8.)
 beste Teiler: 2.0 (20.), 13.0 (7.), 15.2 (4.)
 Trefferlage: 0.68 mm links, 0.28 mm hoch
 Streuwert: 1.00, horizontal: 1.01, vertikal: 0.99

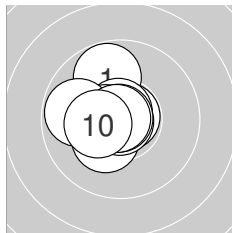
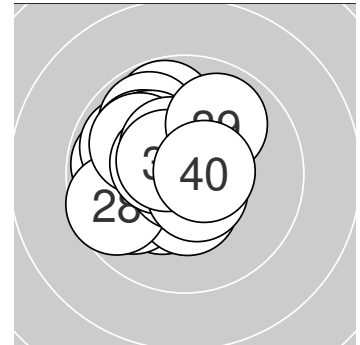

Serie 1: 105.0 (98)

9.8 ↗	10.3* ↘	10.8* ↗	10.9* ↘	10.8* ↗
10.6* ←	10.9* ↘	9.8 ←	10.8* ←	10.3* ←

beste Teiler: 13.0 (7.), 15.2 (4.), 26.4 (9.)
 Trefferlage: 0.73 mm links, 0.22 mm hoch
 Streuwert: 0.97, horizontal: 0.92, vertikal: 1.02

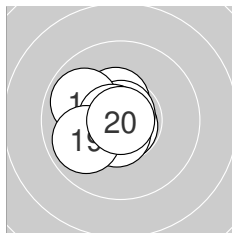

Serie 2: 105.2 (98)

10.4* ↗	10.6* ↘	10.6* ↘	10.8* ↘	10.8* ↑
9.9 ↘	10.7* ←	10.6* ↘	9.9 ↘	10.9* ↓

beste Teiler: 2.0 (20.), 39.1 (15.), 44.2 (14.)
 Trefferlage: 0.67 mm links, 0.09 mm tief
 Streuwert: 0.89, horizontal: 0.92, vertikal: 0.85

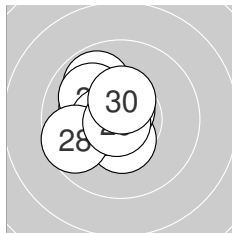

Serie 3: 102.8 (98)

10.2* ↘	10.4* ←	9.8 ↘	10.4* ↓	10.7* ↑
10.0 ↘	10.5* ←	9.6 ←	10.8* ↘	10.4* ↑

beste Teiler: 34.0 (29.), 60.0 (25.), 113.0 (27.)
 Trefferlage: 1.08 mm links, 0.36 mm hoch
 Streuwert: 1.11, horizontal: 1.05, vertikal: 1.16

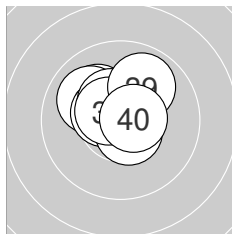

Serie 4: 104.2 (99)

10.8* ↘	10.1 ↘	10.0 ↘	10.5* ↘	10.7* ↗
10.6* ↘	10.4* ↗	10.6* ↘	9.9 ↗	10.6* →

beste Teiler: 37.5 (31.), 55.0 (35.), 85.8 (40.)
 Trefferlage: 0.24 mm links, 0.66 mm hoch
 Streuwert: 1.00, horizontal: 1.10, vertikal: 0.88



Ergebnis: **401.6** (382)
 Serien: 101.6 99.1 100.9 100.0
 Zähler: 25 12 3 0 0 0 0 0 0 0
 Innenzehner: 16
 Weitester: 709 (6.), 624 (16.), 515 (30.)
 beste Teiler: 5.0 (33.), 16.6 (23.), 19.4 (10.)
 Trefferlage: 0.23 mm links, 0.64 mm tief
 Streuwert: 1.94, horizontal: 2.45, vertikal: 1.23

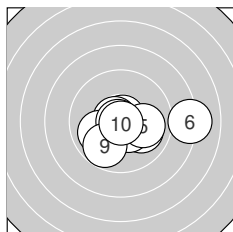
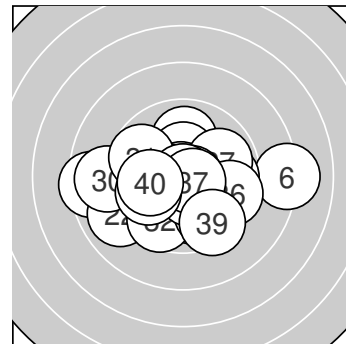

Serie 1: 101.6 (97)

10.0 ↘	10.8* ↗	10.5* ↘	10.7* ↖	10.0 →
8.1 →	10.0 ↙	10.8* ←	9.8 ↗	10.9* ↓

beste Teiler: 19.4 (10.), 28.0 (8.), 47.4 (2.)
 Trefferlage: 0.79 mm rechts, 0.55 mm tief
 Streuwert: 1.95, horizontal: 2.62, vertikal: 0.86

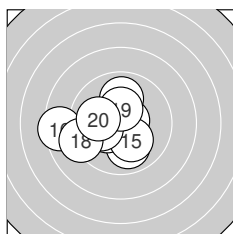

Serie 2: 99.1 (96)

9.9 ↓	10.3* ↙	10.0 ↑	10.6* →	10.1 ↓
8.5 ←	10.1 ↙	9.2 ↙	10.4* ↑	10.0 ↖

beste Teiler: 76.8 (14.), 144.0 (19.), 156.7 (12.)
 Trefferlage: 1.32 mm links, 0.31 mm tief
 Streuwert: 1.99, horizontal: 2.38, vertikal: 1.51

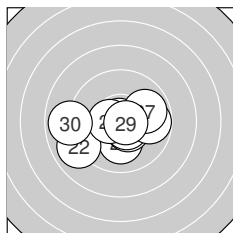

Serie 3: 100.9 (95)

10.1 ↓	9.0 ↙	10.9* ↖	10.5* ↘	10.6* ↘
9.8 →	9.9 ↗	10.5* ←	10.7* →	8.9 ←

beste Teiler: 16.6 (23.), 55.3 (29.), 91.2 (25.)
 Trefferlage: 0.33 mm links, 0.55 mm tief
 Streuwert: 1.99, horizontal: 2.60, vertikal: 1.06

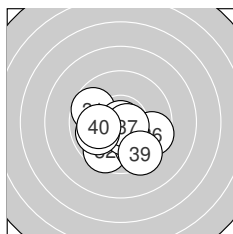

Serie 4: 100.0 (94)

9.7 ↖	9.6 ↗	10.9* ↓	9.7 ↓	10.4* ↓
9.6 ↘	10.7* ↘	9.9 ↙	9.5 ↓	10.0 ←

beste Teiler: 5.0 (33.), 75.1 (37.), 128.5 (35.)
 Trefferlage: 0.09 mm links, 1.16 mm tief
 Streuwert: 1.76, horizontal: 2.07, vertikal: 1.39



Ergebnis: **421.8** (400)
 Serien: 104.3 105.6 105.4 106.5
 Zähler: 40 0 0 0 0 0 0 0 0 0
 Innenzehner: 36
 Weitester: 248 (14.), 247 (28.), 235 (6.)
 beste Teiler: 11.6 (16.), 17.6 (11.), 20.5 (39.)
 Trefferlage: 0.02 mm rechts, 0.02 mm hoch
 Streuwert: 0.88, horizontal: 0.91, vertikal: 0.84

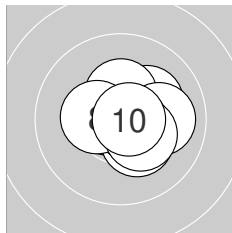
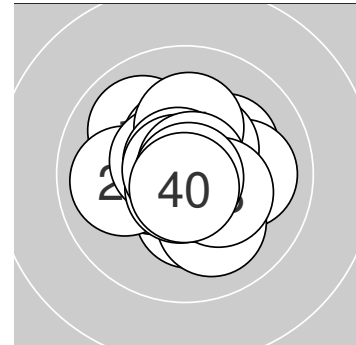

Serie 1: 104.3 (100)

10.7* →	10.2* ↗	10.7* ←	10.4* ↑	10.3* ↘
10.0 →	10.6* ↘	10.4* ←	10.3* ↘	10.7* →

beste Teiler: 51.0 (10.), 65.2 (1.), 74.1 (3.)
 Trefferlage: 0.59 mm rechts, 0.01 mm tief
 Streuwert: 0.97, horizontal: 1.11, vertikal: 0.81

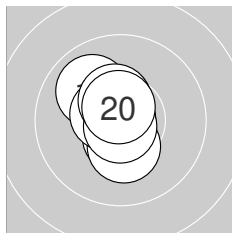

Serie 2: 105.6 (100)

10.9* ↘	10.5* ↓	10.5* ↑	10.0 ↘	10.3* ↓
10.9* ↘	10.6* ↖	10.8* ↓	10.5* ↑	10.6* ↑

beste Teiler: 11.6 (16.), 17.6 (11.), 38.1 (18.)
 Trefferlage: 0.35 mm links, 0.24 mm hoch
 Streuwert: 0.84, horizontal: 0.56, vertikal: 1.05

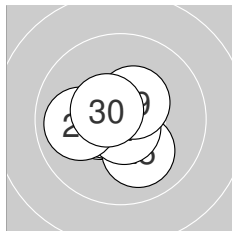

Serie 3: 105.4 (100)

10.5* ←	10.9* →	10.9* ↗	10.6* ←	10.1 ↘
10.7* ↖	10.7* ↓	10.0 ←	10.4* ↗	10.6* ↖

beste Teiler: 24.0 (22.), 24.0 (23.), 57.3 (27.)
 Trefferlage: 0.37 mm links, 0.14 mm tief
 Streuwert: 0.92, horizontal: 1.04, vertikal: 0.78

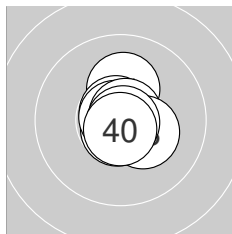

Serie 4: 106.5 (100)

10.2* ↑	10.7* ↘	10.7* ↓	10.8* ↖	10.7* ↘
10.7* ↘	10.8* ↗	10.3* ↘	10.9* ↘	10.7* ↓

beste Teiler: 20.5 (39.), 37.2 (34.), 43.1 (37.)
 Trefferlage: 0.22 mm rechts, 0.01 mm hoch
 Streuwert: 0.66, horizontal: 0.52, vertikal: 0.78



Ergebnis: 410.3 (392)
Serien: 100.7 102.4 103.8 103.4
Zähler: 32 8 0 0 0 0 0 0 0 0
Innenzehner: 23
Weiteste: 490 (5.), 393 (2.), 351 (7.)
beste Teiler: 20.0 (8.), 24.0 (31.), 55.4 (37.)
Trefferlage: 0.30 mm links, 0.04 mm hoch
Streuwert: 1.43, horizontal: 1.70, vertikal: 1.10

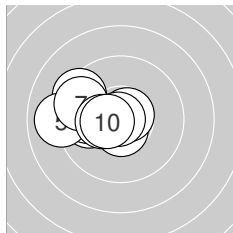
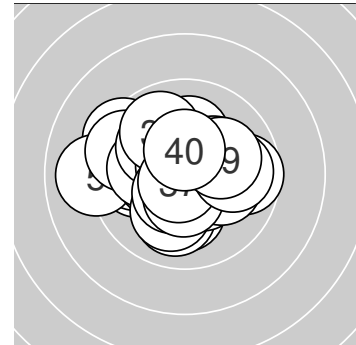

Serie 1: 100.7 (95)

10.6* ↓	9.4 ↖	9.9 ←	9.9 ←	9.0 ←
10.7* ↗	9.5 ↖	10.9* ←	10.3* ←	10.5* ←

beste Teiler: 20.0 (8.), 64.8 (6.), 84.1 (1.)
Trefferlage: 1.91 mm links, 0.24 mm hoch
Streuwert: 1.37, horizontal: 1.75, vertikal: 0.81

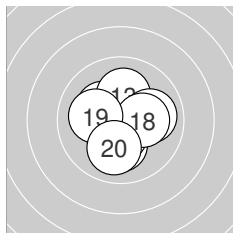

Serie 2: 102.4 (100)

10.7* ↓	10.3* ↖	10.1 ↑	10.4* ↓	10.0 →
10.1 ↓	10.5* ↓	10.2* →	10.1 ←	10.0 ↓

beste Teiler: 64.0 (11.), 119.0 (17.), 138.2 (14.)
Trefferlage: 0.04 mm links, 0.36 mm tief
Streuwert: 1.36, horizontal: 1.35, vertikal: 1.37

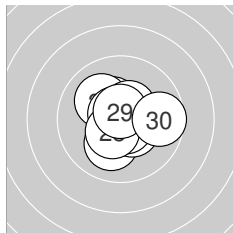

Serie 3: 103.8 (99)

10.4* ↖	10.1 ↓	10.1 ↖	10.4* ↘	10.7* ↖
10.5* ↗	10.7* ↘	10.5* ↙	10.7* ↑	9.7 →

beste Teiler: 65.0 (29.), 65.7 (25.), 75.7 (27.)
Trefferlage: 0.10 mm rechts, 0.02 mm hoch
Streuwert: 1.24, horizontal: 1.33, vertikal: 1.14

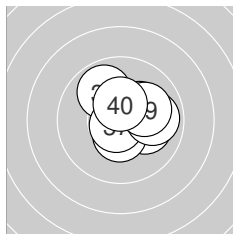

Serie 4: 103.4 (98)

10.9* ↙	9.9 ↖	10.1 →	10.7* ↓	10.2* ↗
10.5* ↓	10.7* ↙	9.9 →	10.1 →	10.4* ↑

beste Teiler: 24.0 (31.), 55.4 (37.), 60.7 (34.)
Trefferlage: 0.63 mm rechts, 0.26 mm hoch
Streuwert: 1.20, horizontal: 1.31, vertikal: 1.08



Ergebnis: 408.0 (390)
Serien: 103.0 100.6 103.3 101.1
Zähler: 31 8 1 0 0 0 0 0 0 0
Innenzehner: 23
Weiteste: 561 (14.), 354 (21.), 348 (39.)
beste Teiler: 20.0 (30.), 22.0 (15.), 32.4 (27.)
Trefferlage: 0.03 mm links, 0.01 mm tief
Streuwert: 1.56, horizontal: 1.77, vertikal: 1.32

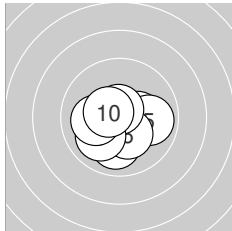
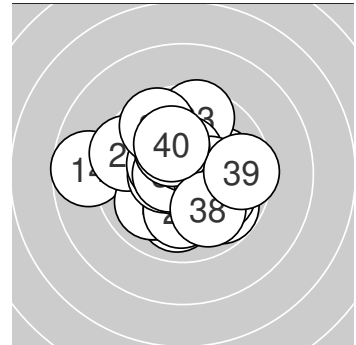

Serie 1: 103.0 (99)

10.4* ←	10.0 ↓	10.3* →	10.8* ↘	9.9 →
10.3* ↘	10.7* ↑	10.0 ↗	10.1 ←	10.5* ↖

beste Teiler: 33.2 (4.), 68.7 (7.), 109.5 (10.)
Trefferlage: 0.13 mm links, 0.52 mm tief
Streuwert: 1.26, horizontal: 1.48, vertikal: 0.98

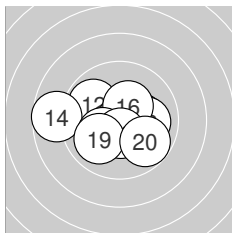

Serie 2: 100.6 (96)

10.2* →	9.9 ↖	10.0 →	8.7 ←	10.9* →
10.4* ↗	10.2* ↗	10.5* ↓	10.0 ↗	9.8 ↘

beste Teiler: 22.0 (15.), 116.4 (18.), 147.4 (16.)
Trefferlage: 0.37 mm links, 0.28 mm tief
Streuwert: 1.94, horizontal: 2.48, vertikal: 1.15

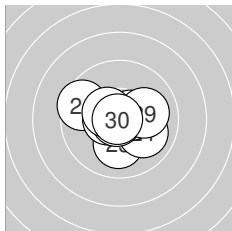

Serie 3: 103.3 (99)

9.5 ↖	10.3* ↓	10.1 ↓	10.0 ↘	10.6* →
10.5* ←	10.8* ↗	10.5* ↖	10.1 →	10.9* ←

beste Teiler: 20.0 (30.), 32.4 (27.), 100.9 (25.)
Trefferlage: 0.08 mm links, 0.25 mm tief
Streuwert: 1.38, horizontal: 1.61, vertikal: 1.09

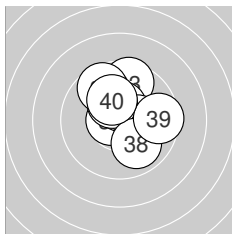

Serie 4: 101.1 (96)

10.4* ↗	10.6* ←	9.6 ↑	10.5* ↑	10.3* →
10.3* ↘	9.7 ↘	9.9 ↘	9.6 →	10.2* ↗

beste Teiler: 76.0 (32.), 122.9 (34.), 131.9 (31.)
Trefferlage: 0.44 mm rechts, 1.00 mm hoch
Streuwert: 1.53, horizontal: 1.48, vertikal: 1.57



Ergebnis: **415.2** (395)
 Serien: 103.7 102.4 105.6 103.5
 Zähler: 35 5 0 0 0 0 0 0 0 0
 Innenzehner: 30
 Weitestе: 314 (15.), 286 (38.), 278 (39.)
 beste Teiler: 13.0 (27.), 25.0 (29.), 42.4 (12.)
 Trefferlage: 0.24 mm rechts, 0.47 mm hoch
 Streuwert: 1.10, horizontal: 1.26, vertikal: 0.92

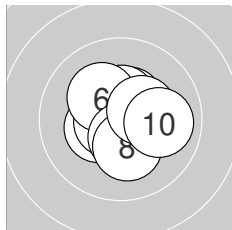
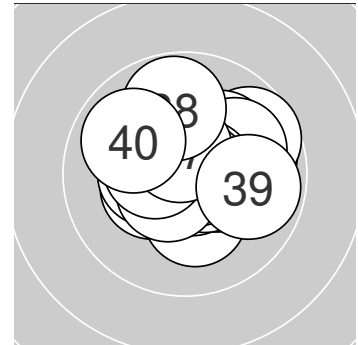

Serie 1: 103.7 (100)

10.4* ←	10.4* →	10.6* ←	10.5* ↑	10.5* ↑
10.2* ↘	10.5* ↓	10.2* ↓	10.4* →	10.0 →

beste Teiler: 80.2 (3.), 116.8 (7.), 124.1 (5.)
 Trefferlage: 0.29 mm rechts, 0.07 mm hoch
 Streuwert: 1.14, horizontal: 1.22, vertikal: 1.05

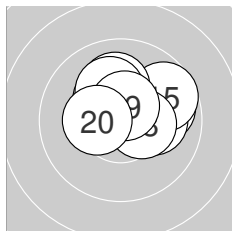

Serie 2: 102.4 (98)

9.9 →	10.8* ↑	10.1 →	10.3* ↘	9.7 ↘
10.1 ↑	10.2* ↑	10.4* →	10.6* ↑	10.3* ←

beste Teiler: 42.4 (12.), 96.5 (19.), 138.1 (18.)
 Trefferlage: 0.57 mm rechts, 0.87 mm hoch
 Streuwert: 1.23, horizontal: 1.52, vertikal: 0.83

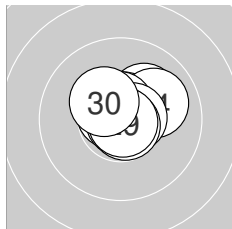

Serie 3: 105.6 (100)

10.1 ↗	10.7* ↘	10.6* ↑	10.0 →	10.6* ↑
10.7* →	10.9* ↓	10.8* ↘	10.9* ↘	10.3* ↘

beste Teiler: 13.0 (27.), 25.0 (29.), 50.6 (28.)
 Trefferlage: 0.32 mm rechts, 0.48 mm hoch
 Streuwert: 0.80, horizontal: 0.94, vertikal: 0.62

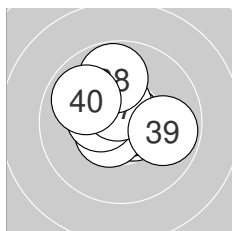

Serie 4: 103.5 (97)

10.6* →	10.7* →	10.6* ↘	10.6* ←	10.6* ↙
10.4* ←	10.5* ↑	9.8 ↑	9.8 →	9.9 ↘

beste Teiler: 55.0 (32.), 79.0 (34.), 88.8 (31.)
 Trefferlage: 0.23 mm links, 0.45 mm hoch
 Streuwert: 1.22, horizontal: 1.36, vertikal: 1.06



Ergebnis: **404.3** (384)
 Serien: 102.1 98.7 101.8 101.7
 Zähler: 24 16 0 0 0 0 0 0 0 0
 Innenzehner: 21
 Weitestе: 472 (7.), 432 (23.), 425 (39.)
 beste Teiler: 19.1 (2.), 32.7 (27.), 33.9 (1.)
 Trefferlage: 0.07 mm links, 0.30 mm hoch
 Streuwert: 1.72, horizontal: 1.80, vertikal: 1.65

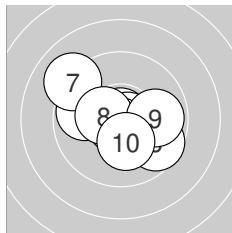
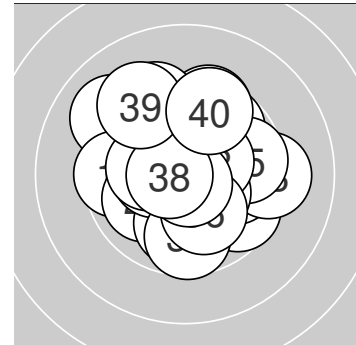

Serie 1: 102.1 (96)

10.8* ↓	10.9* ↑	10.7* →	10.7* ↙	9.8 ←
9.6 ↘	9.1 ↘	10.4* ←	9.9 →	10.2* ↓

beste Teiler: 19.1 (2.), 33.9 (1.), 54.8 (3.)
 Trefferlage: 0.16 mm links, 0.03 mm tief
 Streuwert: 1.73, horizontal: 2.06, vertikal: 1.31

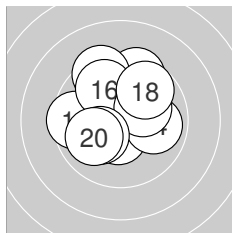

Serie 2: 98.7 (94)

10.5* ↓	9.5 ↑	9.5 ←	9.9 →	9.4 ↘
9.8 ↘	10.2* ↗	9.7 ↗	10.2* ↗	10.0 ↗

beste Teiler: 122.3 (11.), 197.2 (19.), 197.8 (17.)
 Trefferlage: 0.27 mm links, 0.87 mm hoch
 Streuwert: 1.98, horizontal: 2.03, vertikal: 1.94

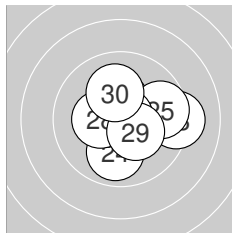

Serie 3: 101.8 (97)

10.4* ↑	10.6* ↖	9.2 →	9.9 ↓	9.7 →
10.5* ←	10.8* ↗	10.3* ←	10.3* ↘	10.1 ↑

beste Teiler: 32.7 (27.), 80.0 (22.), 115.1 (26.)
 Trefferlage: 0.45 mm rechts, 0.10 mm hoch
 Streuwert: 1.60, horizontal: 1.89, vertikal: 1.24

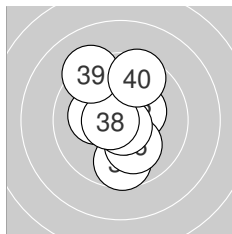

Serie 4: 101.7 (97)

10.7* ↖	10.4* ↗	9.7 ↓	10.4* ↖	10.2* ←
10.1 ↓	10.7* ↓	10.6* ←	9.3 ↘	9.6 ↑

beste Teiler: 52.3 (37.), 61.3 (31.), 80.1 (38.)
 Trefferlage: 0.29 mm links, 0.29 mm hoch
 Streuwert: 1.71, horizontal: 1.29, vertikal: 2.05



Ergebnis: **406.7** (387)
 Serien: 104.4 102.3 101.6 98.4
 Zähler: 27 13 0 0 0 0 0 0 0 0
 Innenzehner: 20
 Weitestе: 463 (31.), 440 (40.), 407 (37.)
 beste Teiler: 19.4 (13.), 35.1 (18.), 36.6 (26.)
 Trefferlage: 0.06 mm links, 0.44 mm tief
 Streuwert: 1.61, horizontal: 1.83, vertikal: 1.36

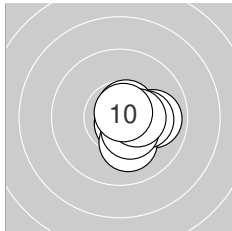
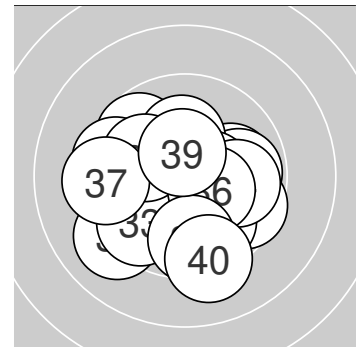

Serie 1: 104.4 (99)

10.5* ↘	10.8* ↘	10.7* ↘	9.9 →	10.1 ↓
10.6* ↗	10.2* →	10.4* ↘	10.4* →	10.8* ↗

beste Teiler: 46.2 (10.), 49.8 (2.), 57.4 (3.)
 Trefferlage: 0.93 mm rechts, 0.41 mm tief
 Streuwert: 0.76, horizontal: 0.77, vertikal: 0.74

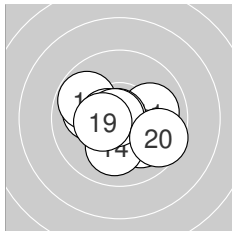

Serie 2: 102.3 (98)

10.0 →	10.0 ↘	10.9* ←	10.1 ↓	10.1 ←
9.8 ↖	10.6* ←	10.8* ←	10.4* ←	9.6 ↘

beste Teiler: 19.4 (13.), 35.1 (18.), 93.0 (17.)
 Trefferlage: 0.08 mm links, 0.31 mm tief
 Streuwert: 1.53, horizontal: 1.86, vertikal: 1.10

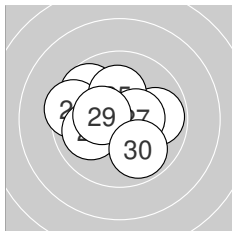

Serie 3: 101.6 (96)

9.9 →	10.7* ←	9.7 ↖	9.5 ←	10.2* ↑
10.8* ↓	10.5* →	10.0 ←	10.4* ←	9.9 ↓

beste Teiler: 36.6 (26.), 66.2 (22.), 125.3 (27.)
 Trefferlage: 0.47 mm links, 0.19 mm hoch
 Streuwert: 1.64, horizontal: 1.95, vertikal: 1.26

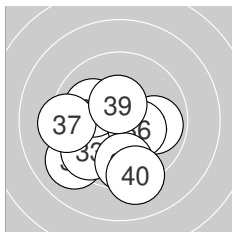

Serie 4: 98.4 (94)

9.1 ↙	10.7* ↓	9.6 ↙	9.9 →	10.1 ↖
10.3* ↘	9.3 ←	9.7 ↓	10.5* ↑	9.2 ↓

beste Teiler: 61.4 (32.), 121.8 (39.), 152.5 (36.)
 Trefferlage: 0.62 mm links, 1.26 mm tief
 Streuwert: 2.05, horizontal: 2.23, vertikal: 1.85



Ergebnis: **417.9** (397)
 Serien: 104.5 104.1 104.9 104.4
 Zähler: 37 3 0 0 0 0 0 0 0 0 0
 Innenzehner: 36
 Weitestе: 292 (21.), 262 (15.), 261 (13.)
 beste Teiler: 27.0 (11.), 44.0 (12.), 44.2 (9.)
 Trefferlage: 0.21 mm rechts, 0.06 mm hoch
 Streuwert: 1.01, horizontal: 1.08, vertikal: 0.93

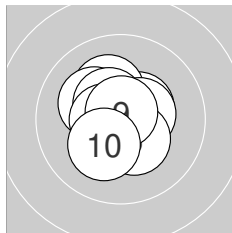
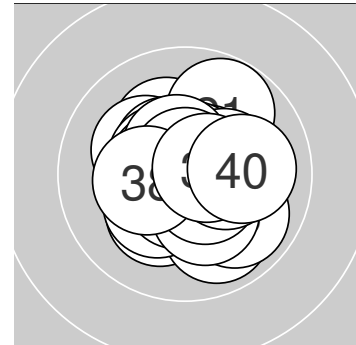

Serie 1: 104.5 (100)

10.4* ↗	10.2* ↖	10.5* →	10.2* ↖	10.4* ↘
10.7* ←	10.5* ↖	10.6* ←	10.8* ↑	10.2* ↘

beste Teiler: 44.2 (9.), 54.3 (6.), 94.0 (8.)
 Trefferlage: 0.24 mm links, 0.24 mm hoch
 Streuwert: 0.99, horizontal: 0.98, vertikal: 1.00

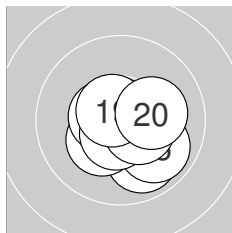

Serie 2: 104.1 (98)

10.8* ↓	10.8* ↖	9.9 ↘	10.3* ↗	9.9 ↘
10.5* ←	10.6* ↘	10.5* ↘	10.6* ↖	10.2* →

beste Teiler: 27.0 (11.), 44.0 (12.), 78.6 (19.)
 Trefferlage: 0.32 mm rechts, 0.50 mm tief
 Streuwert: 1.08, horizontal: 1.18, vertikal: 0.97

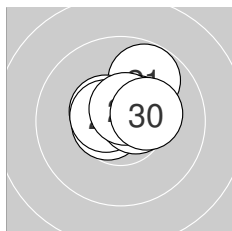

Serie 3: 104.9 (99)

9.8 ↗	10.5* ↗	10.7* ↗	10.7* ←	10.5* ↖
10.6* ←	10.6* ↖	10.6* →	10.6* ↑	10.3* →

beste Teiler: 73.0 (23.), 74.1 (24.), 80.6 (26.)
 Trefferlage: 0.24 mm rechts, 0.57 mm hoch
 Streuwert: 0.88, horizontal: 1.01, vertikal: 0.74

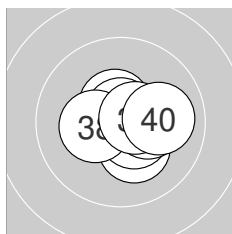

Serie 4: 104.4 (100)

10.4* ↘	10.3* ↘	10.7* ↖	10.5* ↘	10.3* →
10.5* ↖	10.8* ↑	10.3* ←	10.6* →	10.0 →

beste Teiler: 50.0 (37.), 69.3 (33.), 93.6 (39.)
 Trefferlage: 0.53 mm rechts, 0.06 mm tief
 Streuwert: 0.97, horizontal: 1.15, vertikal: 0.74



Ergebnis: **409.3** (390)
 Serien: 102.8 102.6 102.8 101.1
 Zähler: 30 10 0 0 0 0 0 0 0 0
 Innenzehner: 27
 Weitestе: 473 (39.), 414 (5.), 337 (12.)
 beste Teiler: 35.1 (17.), 48.6 (31.), 53.0 (24.)
 Trefferlage: 0.15 mm rechts, 0.13 mm hoch
 Streuwert: 1.49, horizontal: 1.57, vertikal: 1.41

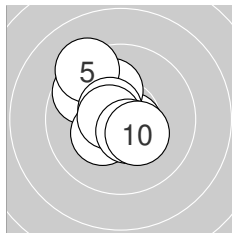
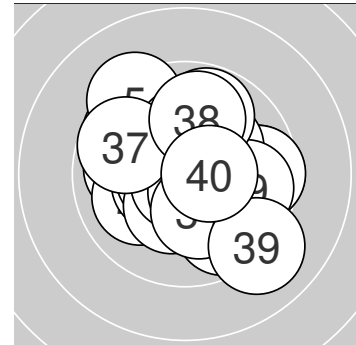

Serie 1: 102.8 (98)

10.6* ↘	10.7* ↓	9.7 ↗	10.1 ↑	9.3 ↖
10.6* ↖	10.3* ↗	10.6* ←	10.6* ↓	10.3* ↘

beste Teiler: 64.0 (2.), 76.9 (1.), 80.4 (8.)
 Trefferlage: 0.59 mm links, 0.43 mm hoch
 Streuwert: 1.39, horizontal: 1.23, vertikal: 1.53

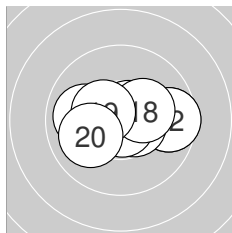

Serie 2: 102.6 (98)

9.6 →	9.6 →	10.7* ↗	10.6* →	10.6* ←
10.0 ←	10.8* ↓	10.3* →	10.4* ↖	10.0 ↗

beste Teiler: 35.1 (17.), 75.6 (13.), 91.9 (15.)
 Trefferlage: 0.32 mm rechts, 0.01 mm hoch
 Streuwert: 1.50, horizontal: 2.05, vertikal: 0.53

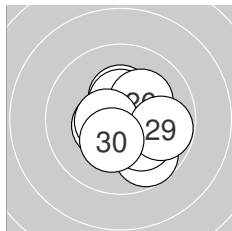

Serie 3: 102.8 (98)

10.5* ←	10.3* ↑	10.5* ↑	10.7* ↗	9.7 ↓
10.2* ↗	10.2* ↘	10.6* ←	9.8 →	10.3* ↓

beste Teiler: 53.0 (24.), 98.9 (28.), 124.0 (23.)
 Trefferlage: 0.43 mm rechts, 0.28 mm tief
 Streuwert: 1.33, horizontal: 1.34, vertikal: 1.31

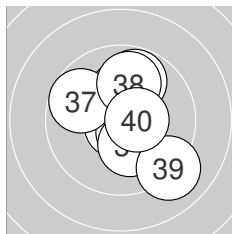

Serie 4: 101.1 (96)

10.8* ↗	10.3* ↑	10.6* ↓	10.2* ↓	9.8 ↑
10.2* ↑	9.7 ↖	9.9 ↑	9.1 ↓	10.5* →

beste Teiler: 48.6 (31.), 97.9 (33.), 114.0 (40.)
 Trefferlage: 0.46 mm rechts, 0.37 mm hoch
 Streuwert: 1.75, horizontal: 1.50, vertikal: 1.97



Ergebnis: 408.9 (390)
Serien: 103.7 101.8 100.6 102.8
Zähler: 30 10 0 0 0 0 0 0 0 0 0
Innenzehner: 25
Weiteste: 433 (11.), 425 (25.), 420 (21.)
beste Teiler: 32.0 (22.), 33.5 (19.), 44.1 (8.)
Trefferlage: 0.14 mm rechts, 0.28 mm tief
Streuwert: 1.49, horizontal: 1.62, vertikal: 1.34

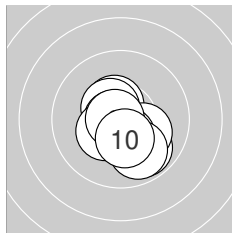
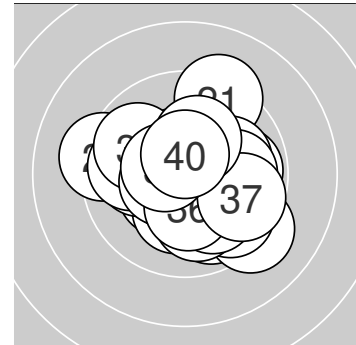

Serie 1: 103.7 (98)

10.5* ↖	9.9 ↘	10.5* ↗	10.2* ↘	10.4* ↓
10.7* ←	10.4* ↗	10.8* ←	9.9 ↘	10.4* ↓

beste Teiler: 44.1 (8.), 57.1 (6.), 117.5 (3.)
Trefferlage: 0.20 mm rechts, 0.71 mm tief
Streuwert: 1.12, horizontal: 1.06, vertikal: 1.18

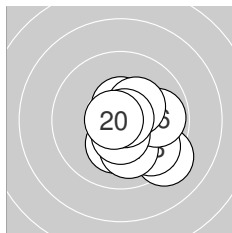

Serie 2: 101.8 (97)

9.2 ↘	10.2* ↓	9.7 ↘	10.0 ↓	10.5* ↑
9.9 →	10.5* ↓	10.3* ↗	10.8* ↗	10.7* ←

beste Teiler: 33.5 (19.), 51.0 (20.), 107.0 (15.)
Trefferlage: 0.95 mm rechts, 0.74 mm tief
Streuwert: 1.39, horizontal: 1.38, vertikal: 1.41

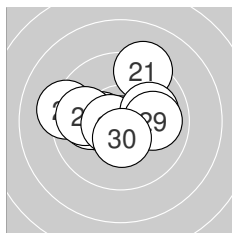

Serie 3: 100.6 (97)

9.3 ↗	10.8* ↓	10.3* ←	10.0 ←	9.3 ←
9.9 ←	10.6* ←	10.0 →	10.0 →	10.4* ↓

beste Teiler: 32.0 (22.), 81.0 (27.), 128.3 (30.)
Trefferlage: 0.49 mm links, 0.41 mm hoch
Streuwert: 1.83, horizontal: 2.21, vertikal: 1.35

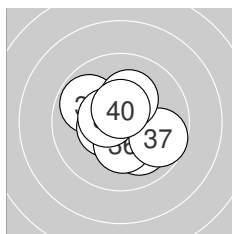

Serie 4: 102.8 (98)

10.7* ↖	10.0 ↘	10.6* ↗	9.8 ↖	10.5* ←
10.3* ↓	9.7 ↘	10.2* ↗	10.5* ←	10.5* ↑

beste Teiler: 74.7 (31.), 96.0 (33.), 101.0 (40.)
Trefferlage: 0.09 mm links, 0.07 mm tief
Streuwert: 1.37, horizontal: 1.48, vertikal: 1.24



Ergebnis: 421.2 (397)
Serien: 103.4 107.5 105.4 104.9
Zähler: 37 3 0 0 0 0 0 0 0 0 0
Innenzehner: 34
Weiteste: 370 (1.), 300 (8.), 251 (40.)
beste Teiler: 7.0 (25.), 18.8 (12.), 19.6 (9.)
Trefferlage: 0.08 mm links, 0.03 mm tief
Streuwert: 0.96, horizontal: 1.19, vertikal: 0.65

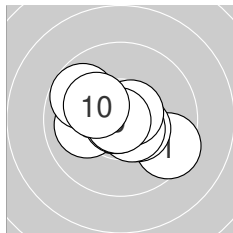
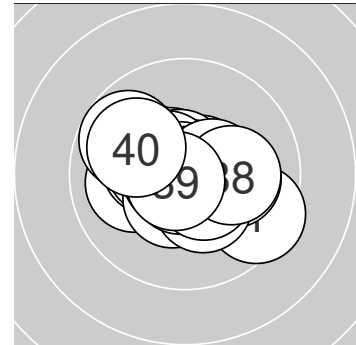

Serie 1: 103.4 (98)

9.5 ↘	10.4* ↘	10.5* ↘	10.6* ↗	10.7* ←
10.0 ←	10.8* ←	9.8 ↘	10.9* ←	10.2* ↘

beste Teiler: 19.6 (9.), 30.3 (7.), 60.4 (5.)
Trefferlage: 0.17 mm links, 0.08 mm tief
Streuwert: 1.40, horizontal: 1.75, vertikal: 0.93

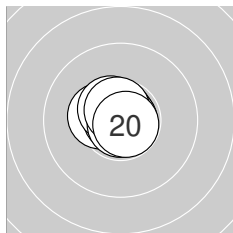

Serie 2: 107.5 (100)

10.4* ←	10.9* ↗	10.8* ←	10.5* ↘	10.9* ↑
10.8* ↑	10.9* →	10.8* ↓	10.7* ↖	10.8* ↘

beste Teiler: 18.8 (12.), 22.0 (15.), 25.0 (17.)
Trefferlage: 0.18 mm links, 0.19 mm hoch
Streuwert: 0.44, horizontal: 0.51, vertikal: 0.35

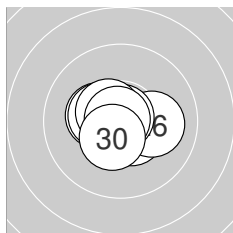

Serie 3: 105.4 (100)

10.5* ↘	10.3* ←	10.6* ←	10.4* ←	10.9* →
10.1 →	10.8* ↑	10.5* ↘	10.8* ↘	10.5* ↙

beste Teiler: 7.0 (25.), 26.4 (29.), 27.1 (27.)
Trefferlage: 0.23 mm links, 0.02 mm tief
Streuwert: 0.85, horizontal: 1.07, vertikal: 0.54

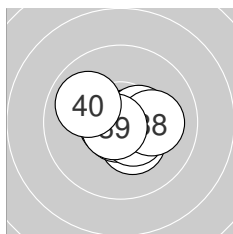

Serie 4: 104.9 (99)

10.6* ↘	10.9* ↘	10.3* ↘	10.7* ↙	10.5* ↘
10.7* ←	10.5* →	10.1 →	10.7* ↙	9.9 ↘

beste Teiler: 25.0 (32.), 52.0 (34.), 53.8 (39.)
Trefferlage: 0.26 mm rechts, 0.21 mm tief
Streuwert: 0.97, horizontal: 1.20, vertikal: 0.67



Ergebnis: 403.4 (384)
Serien: 101.5 101.0 101.5 99.4
Zähler: 24 16 0 0 0 0 0 0 0 0
Innenzehner: 21
Weiteste: 438 (16.), 405 (1.), 358 (32.)
beste Teiler: 40.6 (9.), 44.6 (6.), 65.0 (14.)
Trefferlage: 0.53 mm rechts, 0.51 mm tief
Streuwert: 1.63, horizontal: 1.83, vertikal: 1.40

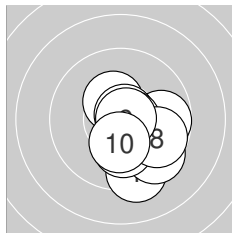
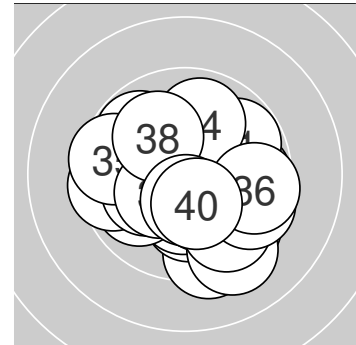

Serie 1: 101.5 (96)

9.3 ↓	10.4* ↖	9.8 →	9.5 ↘	10.1 ↓
10.8* ↗	10.7* →	9.8 ↘	10.8* →	10.3* ↓

beste Teiler: 40.6 (9.), 44.6 (6.), 69.5 (7.)
Trefferlage: 1.03 mm rechts, 1.00 mm tief
Streuwert: 1.43, horizontal: 1.27, vertikal: 1.58

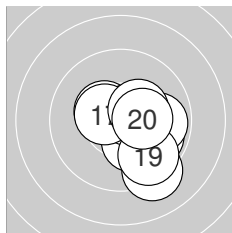

Serie 2: 101.0 (96)

9.9 ↘	10.4* ↖	10.2* ↓	10.7* ↗	9.9 →
9.2 ↓	10.5* ↖	10.3* ↗	9.6 ↘	10.3* →

beste Teiler: 65.0 (14.), 124.6 (17.), 137.4 (12.)
Trefferlage: 1.14 mm rechts, 0.68 mm tief
Streuwert: 1.47, horizontal: 1.41, vertikal: 1.53

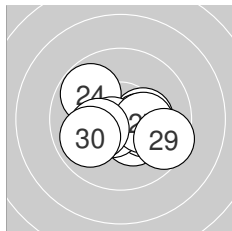

Serie 3: 101.5 (97)

10.3* →	10.4* →	10.3* ↓	9.8 ↖	10.2* →
10.6* ↗	10.3* →	10.2* ↖	9.5 ↘	9.9 ↖

beste Teiler: 88.4 (26.), 145.7 (22.), 152.6 (23.)
Trefferlage: 0.39 mm rechts, 0.45 mm tief
Streuwert: 1.52, horizontal: 1.93, vertikal: 0.95

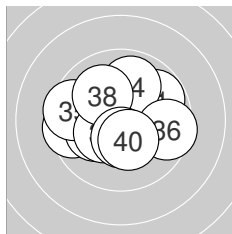

Serie 4: 99.4 (95)

9.8 ↗	9.5 ←	10.1 ←	9.9 ↑	9.5 ←
9.6 →	10.3* ↗	10.0 ↖	10.4* ↓	10.3* ↓

beste Teiler: 129.0 (39.), 153.8 (37.), 156.7 (40.)
Trefferlage: 0.42 mm links, 0.08 mm hoch
Streuwert: 1.93, horizontal: 2.32, vertikal: 1.43



Ergebnis: **414.5** (395)
 Serien: 102.1 104.9 103.5 104.0
 Zähler: 35 5 0 0 0 0 0 0 0 0 0
 Innenzehner: 29
 Weitestе: 393 (9.), 314 (33.), 313 (19.)
 beste Teiler: 3.6 (14.), 27.4 (29.), 29.4 (16.)
 Trefferlage: 0.12 mm rechts, 0.24 mm tief
 Streuwert: 1.23, horizontal: 1.44, vertikal: 0.97

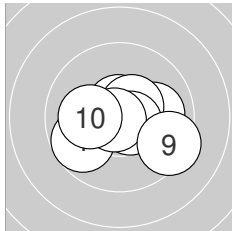
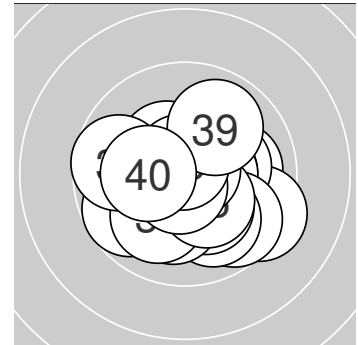

Serie 1: 102.1 (98)

9.7 ↙	10.2* →	10.7* ↑	10.1 →	10.0 →
10.5* ↗	10.6* ↘	10.8* ↙	9.4 ↘	10.1 ←

beste Teiler: 41.5 (8.), 75.5 (3.), 85.4 (7.)
 Trefferlage: 0.62 mm rechts, 0.24 mm tief
 Streuwert: 1.51, horizontal: 1.94, vertikal: 0.88

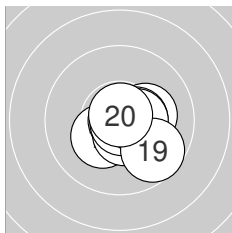

Serie 2: 104.9 (99)

10.6* →	10.3* ↙	10.2* →	10.9* ↘	10.6* ↓
10.8* ↘	10.5* →	10.5* →	9.7 ↘	10.8* ↑

beste Teiler: 3.6 (14.), 29.4 (16.), 37.6 (20.)
 Trefferlage: 0.68 mm rechts, 0.38 mm tief
 Streuwert: 0.90, horizontal: 1.01, vertikal: 0.78

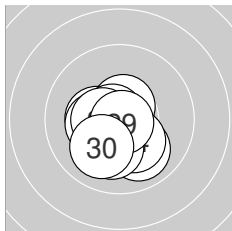

Serie 3: 103.5 (100)

10.6* ↑	10.0 ↓	10.3* ←	10.2* ↓	10.7* ↙
10.1 ↓	10.3* ←	10.5* ←	10.8* ↓	10.0 ↙

beste Teiler: 27.4 (29.), 55.5 (25.), 92.4 (21.)
 Trefferlage: 0.39 mm links, 0.69 mm tief
 Streuwert: 1.06, horizontal: 1.05, vertikal: 1.08

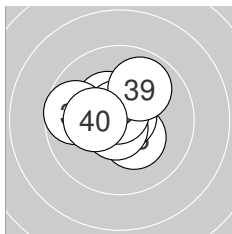

Serie 4: 104.0 (98)

10.4* ↘	10.4* ↘	9.7 ←	10.8* ↓	10.3* ↓
10.8* ↗	10.7* ↓	10.7* ↑	9.9 ↗	10.3* ←

beste Teiler: 41.6 (36.), 47.0 (34.), 57.9 (38.)
 Trefferlage: 0.42 mm links, 0.33 mm hoch
 Streuwert: 1.17, horizontal: 1.34, vertikal: 0.96



Ergebnis: 407.8 (387)
Serien: 101.8 102.5 102.1 101.4
Zähler: 27 13 0 0 0 0 0 0 0 0
Innenzehner: 24
Weiteste: 479 (19.), 393 (31.), 388 (33.)
beste Teiler: 1.0 (25.), 14.0 (7.), 26.2 (26.)
Trefferlage: 0.28 mm links, 0.47 mm hoch
Streuwert: 1.54, horizontal: 1.99, vertikal: 0.88

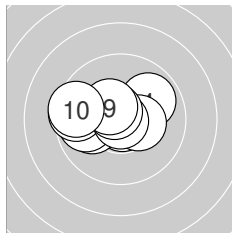
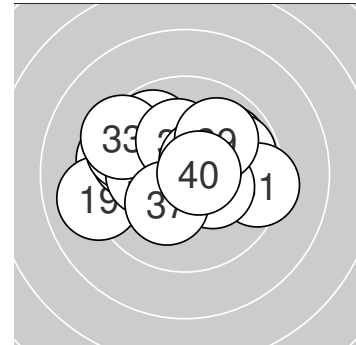

Serie 1: 101.8 (96)

10.8* ↓	10.0 ←	9.8 ←	9.9 ↗	9.5 ←
10.4* →	10.9* ↓	10.6* ↘	10.4* ↘	9.5 ←

beste Teiler: 14.0 (7.), 38.0 (1.), 79.0 (8.)
Trefferlage: 0.97 mm links, 0.26 mm hoch
Streuwert: 1.51, horizontal: 2.02, vertikal: 0.70

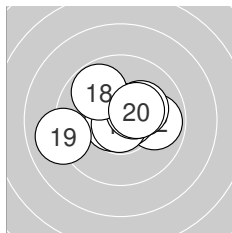

Serie 2: 102.5 (97)

10.6* ↗	9.9 →	10.7* ←	10.7* →	10.2* ↗
10.8* ↓	10.4* ↗	9.8 ↘	9.0 ←	10.4* ↗

beste Teiler: 35.7 (16.), 57.2 (14.), 71.5 (13.)
Trefferlage: 0.05 mm rechts, 0.35 mm hoch
Streuwert: 1.60, horizontal: 2.05, vertikal: 0.96

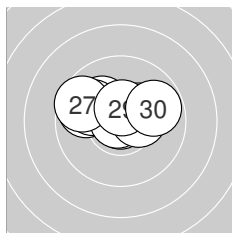

Serie 3: 102.1 (96)

10.3* ↗	10.1 ↘	9.8 ←	9.9 ↘	10.9* ←
10.8* ←	9.6 ↘	10.4* →	10.5* ↑	9.8 ↗

beste Teiler: 1.0 (25.), 26.2 (26.), 107.6 (29.)
Trefferlage: 0.42 mm links, 0.79 mm hoch
Streuwert: 1.42, horizontal: 1.94, vertikal: 0.53

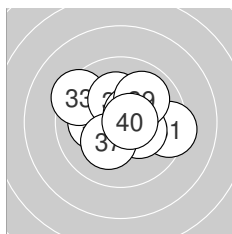

Serie 4: 101.4 (98)

9.4 →	10.2* ←	9.4 ↘	10.5* ↑	10.3* ↘
10.2* ↑	10.2* ↘	10.5* ↗	10.0 ↗	10.7* →

beste Teiler: 75.2 (40.), 109.0 (38.), 114.0 (34.)
Trefferlage: 0.19 mm rechts, 0.46 mm hoch
Streuwert: 1.68, horizontal: 2.04, vertikal: 1.21



Ergebnis: 403.8 (386)
Serien: 98.4 102.1 100.8 102.5
Zähler: 27 12 1 0 0 0 0 0 0 0
Innenzehner: 20
Weiteste: 511 (28.), 471 (26.), 431 (8.)
beste Teiler: 18.4 (15.), 25.6 (37.), 37.0 (18.)
Trefferlage: 0.06 mm rechts, 0.67 mm hoch
Streuwert: 1.69, horizontal: 1.94, vertikal: 1.39

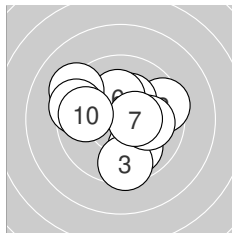
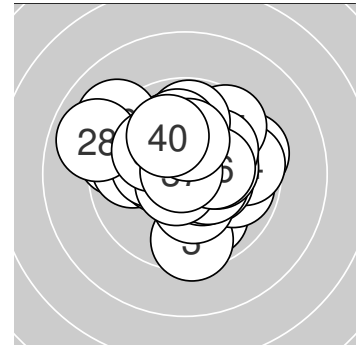

Serie 1: 98.4 (94)

9.9 ↘	9.5 →	9.5 ↓	10.3* ↗	10.1 →
10.2* ↑	10.5* →	9.2 ↙	9.4 ←	9.8 ←

beste Teiler: 117.0 (7.), 167.7 (4.), 183.5 (6.)
Trefferlage: 0.12 mm links, 0.22 mm hoch
Streuwert: 2.18, horizontal: 2.46, vertikal: 1.86

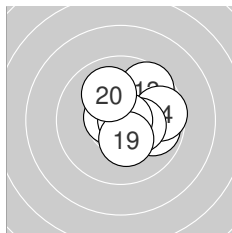

Serie 2: 102.1 (97)

10.0 ↗	9.9 →	9.6 ↗	9.7 →	10.9* ←
10.3* →	10.6* ←	10.8* →	10.3* ↓	10.0 ↖

beste Teiler: 18.4 (15.), 37.0 (18.), 81.6 (17.)
Trefferlage: 1.03 mm rechts, 0.40 mm hoch
Streuwert: 1.35, horizontal: 1.46, vertikal: 1.24

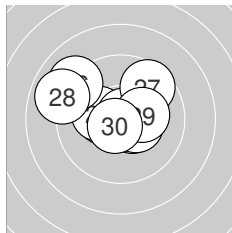

Serie 3: 100.8 (96)

10.4* ←	10.2* ←	10.8* ↗	10.5* ↘	10.4* ↘
9.1 ↙	9.6 ↗	8.9 ↙	10.2* →	10.7* ↘

beste Teiler: 42.4 (23.), 72.3 (30.), 109.7 (24.)
Trefferlage: 0.56 mm links, 0.70 mm hoch
Streuwert: 1.89, horizontal: 2.33, vertikal: 1.30

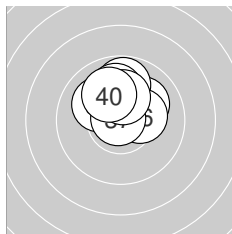

Serie 4: 102.5 (99)

10.7* ↙	10.1 ↗	10.4* ↙	10.1 ↙	9.8 ↑
10.3* →	10.9* ↙	10.0 ↑	10.2* ↑	10.0 ↖

beste Teiler: 25.6 (37.), 58.4 (31.), 138.4 (33.)
Trefferlage: 0.07 mm links, 1.38 mm hoch
Streuwert: 1.00, horizontal: 1.08, vertikal: 0.91



Ergebnis: **406.6** (388)
 Serien: 98.2 104.5 102.2 101.7
 Zähler: 29 10 1 0 0 0 0 0 0 0
 Innenzehner: 23
 Weitesten: 580 (5.), 442 (2.), 412 (26.)
 beste Teiler: 8.6 (22.), 51.1 (8.), 59.9 (34.)
 Trefferlage: 0.50 mm rechts, 0.67 mm hoch
 Streuwert: 1.53, horizontal: 1.86, vertikal: 1.11

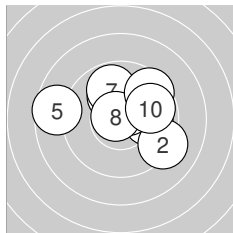
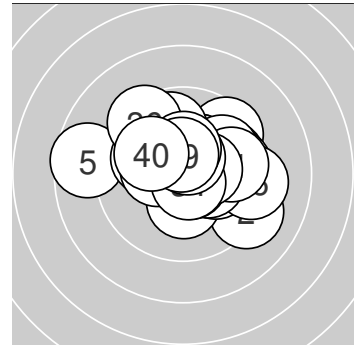

Serie 1: 98.2 (94)

10.0 →	9.2 ↘	10.5* ↗	10.0 ↗	8.6 ←
10.1 ↖	9.8 ↗	10.7* ↖	9.5 ↗	9.8 →

beste Teiler: 51.1 (8.), 103.4 (3.), 219.3 (6.)
 Trefferlage: 0.62 mm rechts, 0.92 mm hoch
 Streuwert: 2.21, horizontal: 2.77, vertikal: 1.44

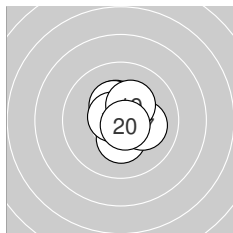

Serie 2: 104.5 (100)

10.5* →	10.3* ↓	10.4* ↗	10.6* ↗	10.6* →
10.4* ↖	10.1 →	10.6* ↖	10.3* ↗	10.7* ↘

beste Teiler: 60.8 (20.), 79.8 (18.), 82.9 (14.)
 Trefferlage: 0.44 mm rechts, 0.23 mm hoch
 Streuwert: 0.93, horizontal: 0.88, vertikal: 0.97

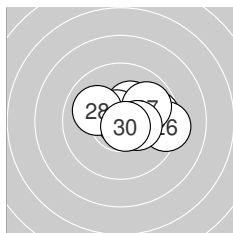

Serie 3: 102.2 (97)

10.4* ↗	10.9* ↗	9.7 →	10.3* ↗	10.7* ↖
9.3 →	9.9 ↗	10.0 ↖	10.3* →	10.7* ↘

beste Teiler: 8.6 (22.), 64.3 (30.), 68.2 (25.)
 Trefferlage: 1.10 mm rechts, 0.40 mm hoch
 Streuwert: 1.36, horizontal: 1.78, vertikal: 0.70

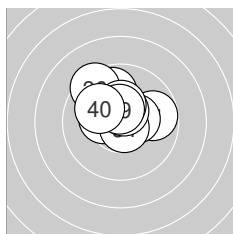

Serie 4: 101.7 (97)

9.8 →	10.4* →	10.3* ←	10.7* ↘	9.8 ↗
9.4 ↖	10.5* ↗	10.3* ↗	10.5* ↗	10.0 ↖

beste Teiler: 59.9 (34.), 104.4 (37.), 117.4 (39.)
 Trefferlage: 0.16 mm links, 1.14 mm hoch
 Streuwert: 1.35, horizontal: 1.57, vertikal: 1.10



Ergebnis: 412.0 (395)
Serien: 104.1 102.5 103.1 102.3
Zähler: 35 5 0 0 0 0 0 0 0 0 0
Innenzehner: 29
Weiteste: 377 (33.), 360 (19.), 345 (38.)
beste Teiler: 23.3 (40.), 28.4 (35.), 31.1 (1.)
Trefferlage: 0.71 mm rechts, 0.43 mm tief
Streuwert: 1.18, horizontal: 1.23, vertikal: 1.14

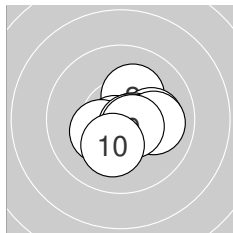
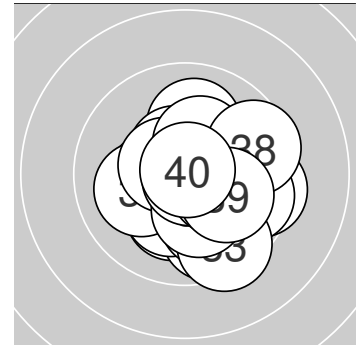

Serie 1: 104.1 (100)

10.8* →	10.2* ↗	10.1 →	10.7* ↙	10.6* ↘
10.3* ↖	10.6* ↘	10.0 →	10.6* ↘	10.2* ↙

beste Teiler: 31.1 (1.), 70.2 (4.), 80.7 (7.)
Trefferlage: 0.57 mm rechts, 0.32 mm tief
Streuwert: 1.02, horizontal: 1.16, vertikal: 0.87

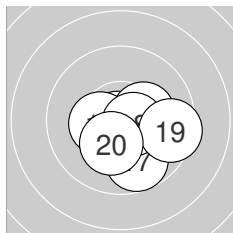

Serie 2: 102.5 (98)

10.8* ↖	10.3* →	10.3* ↘	10.4* ←	10.3* ↘
10.4* ↘	9.7 ↘	10.6* →	9.5 →	10.2* ↙

beste Teiler: 31.2 (11.), 93.3 (18.), 132.4 (16.)
Trefferlage: 0.82 mm rechts, 0.83 mm tief
Streuwert: 1.17, horizontal: 1.38, vertikal: 0.90

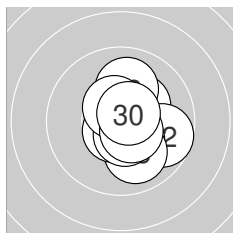

Serie 3: 103.1 (99)

10.3* ↗	9.7 ↘	10.0 ↑	10.3* ↘	10.0 ↘
10.6* ↖	10.6* ↘	10.5* ↖	10.5* ↘	10.6* ↗

beste Teiler: 78.4 (30.), 82.0 (26.), 99.9 (27.)
Trefferlage: 0.72 mm rechts, 0.19 mm tief
Streuwert: 1.18, horizontal: 0.96, vertikal: 1.36

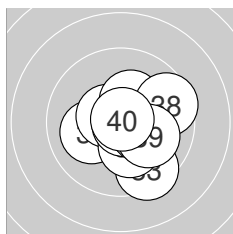

Serie 4: 102.3 (98)

10.1 ←	10.6* ↖	9.4 ↘	10.2* ↘	10.8* ↘
10.3* ↗	10.3* ↘	9.6 →	10.1 ↘	10.9* ↗

beste Teiler: 23.3 (40.), 28.4 (35.), 100.6 (32.)
Trefferlage: 0.73 mm rechts, 0.41 mm tief
Streuwert: 1.46, horizontal: 1.52, vertikal: 1.40



Ergebnis: **409.6** (389)
Serien: 102.9 103.4 102.5 100.8
Zähler: 31 8 0 1 0 0 0 0 0 0
Innenzehner: 26
Weiteste: 789 (4.), 394 (39.), 360 (13.)
beste Teiler: 14.0 (26.), 18.0 (3.), 23.0 (9.)
Trefferlage: 0.47 mm rechts, 0.17 mm tief
Streuwert: 1.57, horizontal: 1.99, vertikal: 0.98

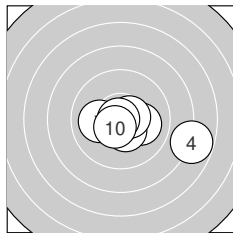
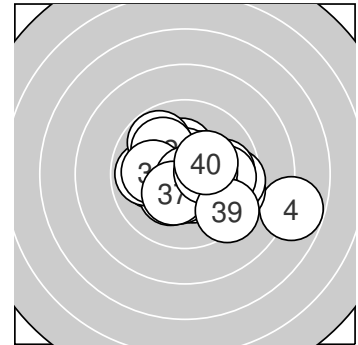

Serie 1: 102.9 (97)

10.1 → 10.7* ↙ 10.9* ↓ 7.8 → 10.4* ↘
 10.8* ↙ 10.1 ← 10.6* → 10.9* ← 10.6* ↙
beste Teiler: 18.0 (3.), 23.0 (9.), 38.9 (6.)
Trefferlage: 0.73 mm rechts, 0.59 mm tief
Streuwert: 1.93, horizontal: 2.63, vertikal: 0.76

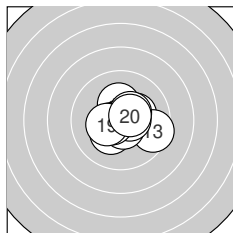

Serie 2: 103.4 (99)

10.3* → 10.3* ↙ 9.5 → 10.3* ↑ 10.6* ↘
 10.6* → 10.6* ↙ 10.4* ↗ 10.3* ← 10.5* ↗
beste Teiler: 86.6 (15.), 97.0 (16.), 98.2 (17.)
Trefferlage: 0.46 mm rechts, 0.05 mm tief
Streuwert: 1.23, horizontal: 1.45, vertikal: 0.96

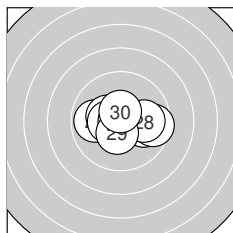

Serie 3: 102.5 (97)

10.6* ↙ 9.9 ← 10.3* ↖ 10.4* ← 9.9 →
 10.9* ← 9.6 → 10.0 → 10.4* ↓ 10.5* ↑
beste Teiler: 14.0 (26.), 92.1 (21.), 102.0 (30.)
Trefferlage: 0.20 mm rechts, 0.15 mm tief
Streuwert: 1.46, horizontal: 1.96, vertikal: 0.65

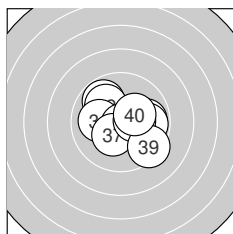

Serie 4: 100.8 (96)

9.8 ↘ 10.0 ↘ 9.9 → 10.1 ← 9.8 →
 10.8* ↘ 10.3* ↙ 10.4* → 9.4 ↘ 10.3* ↗
beste Teiler: 30.8 (36.), 146.7 (38.), 156.5 (37.)
Trefferlage: 0.51 mm rechts, 0.09 mm hoch
Streuwert: 1.74, horizontal: 2.03, vertikal: 1.39



Ergebnis: **420.1** (400)
Serien: 105.5 104.9 103.8 105.9
Zähler: 40 0 0 0 0 0 0 0 0 0 0
Innenzehner: 36
Weiteste: 239 (25.), 230 (12.), 216 (30.)
beste Teiler: 9.2 (15.), 13.6 (39.), 35.7 (8.)
Trefferlage: 0.09 mm links, 0.12 mm tief
Streuwert: 0.91, horizontal: 0.98, vertikal: 0.83

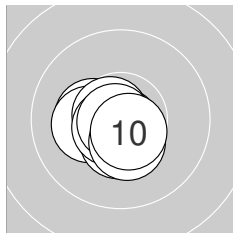
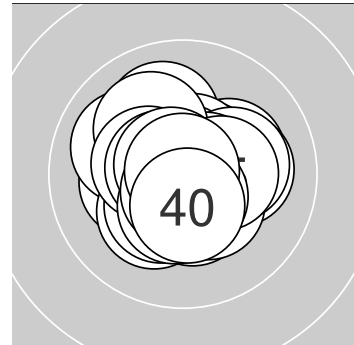

Serie 1: 105.5 (100)

10.3* ←	10.8* ↓	10.6* ←	10.2* ←	10.5* ↓
10.7* ↖	10.6* ↗	10.8* ↗	10.4* ↓	10.6* ↘

beste Teiler: 35.7 (8.), 41.5 (2.), 65.9 (6.)
Trefferlage: 0.51 mm links, 0.42 mm tief
Streuwert: 0.67, horizontal: 0.77, vertikal: 0.54

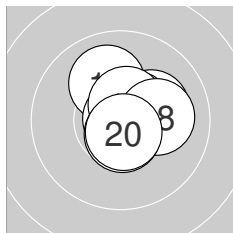

Serie 2: 104.9 (100)

10.2* →	10.0 ↖	10.6* →	10.7* →	10.9* ↑
10.5* ↗	10.6* ↑	10.1 →	10.6* ↓	10.7* ↓

beste Teiler: 9.2 (15.), 61.4 (14.), 72.2 (20.)
Trefferlage: 0.59 mm rechts, 0.34 mm hoch
Streuwert: 0.85, horizontal: 0.85, vertikal: 0.85

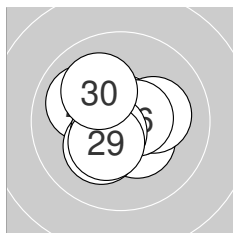

Serie 3: 103.8 (100)

10.6* ↙	10.7* ↑	10.4* ↘	10.2* →	10.0 ↖
10.6* →	10.2* ↗	10.6* ↗	10.4* ↗	10.1 ↖

beste Teiler: 51.0 (22.), 84.6 (21.), 86.8 (26.)
Trefferlage: 0.26 mm links, 0.13 mm tief
Streuwert: 1.15, horizontal: 1.22, vertikal: 1.07

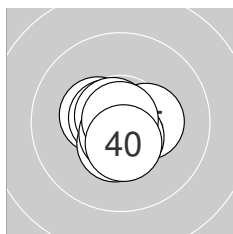

Serie 4: 105.9 (100)

10.4* ←	10.7* ←	10.6* ←	10.4* ↓	10.4* →
10.7* ↖	10.6* ↓	10.7* ↓	10.9* ↖	10.5* ↓

beste Teiler: 13.6 (39.), 59.0 (36.), 69.6 (32.)
Trefferlage: 0.19 mm links, 0.27 mm tief
Streuwert: 0.72, horizontal: 0.77, vertikal: 0.67



Ergebnis: 415.7 (394)
Serien: 106.1 102.6 104.0 103.0
Zähler: 34 6 0 0 0 0 0 0 0 0 0
Innenzehner: 32
Weiteste: 393 (27.), 390 (20.), 342 (19.)
beste Teiler: 10.0 (2.), 25.0 (1.), 25.0 (23.)
Trefferlage: 0.07 mm rechts, 0.30 mm tief
Streuwert: 1.21, horizontal: 1.49, vertikal: 0.83

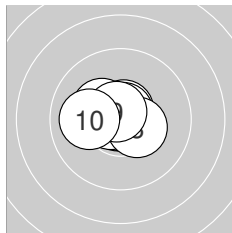
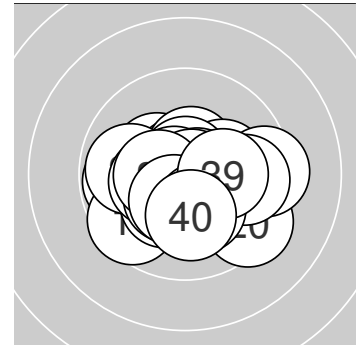

Serie 1: 106.1 (100)

10.9* ↖	10.9* ↓	10.7* ↑	10.8* ↗	10.3* ↘
10.7* ↑	10.7* ←	10.4* ↘	10.7* ↘	10.0 ←

beste Teiler: 10.0 (2.), 25.0 (1.), 33.1 (4.)
Trefferlage: 0.30 mm links, 0.18 mm hoch
Streuwert: 0.76, horizontal: 0.98, vertikal: 0.43

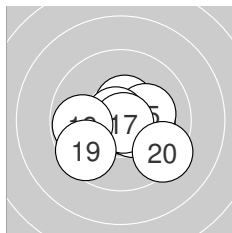

Serie 2: 102.6 (97)

10.2* →	10.5* ↑	10.8* ↓	10.5* ↘	10.2* →
10.8* ↘	10.8* ↘	9.8 ←	9.6 ↖	9.4 ↘

beste Teiler: 26.1 (13.), 29.0 (17.), 42.7 (16.)
Trefferlage: 0.24 mm rechts, 0.44 mm tief
Streuwert: 1.53, horizontal: 1.88, vertikal: 1.09

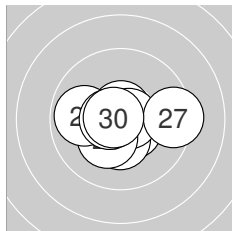

Serie 3: 104.0 (98)

10.5* ↘	10.3* ↓	10.9* ↑	10.7* ↑	10.7* →
10.3* ↖	9.4 →	9.9 ←	10.6* ←	10.7* ←

beste Teiler: 25.0 (23.), 54.3 (30.), 60.1 (25.)
Trefferlage: 0.03 mm rechts, 0.22 mm tief
Streuwert: 1.30, horizontal: 1.69, vertikal: 0.73

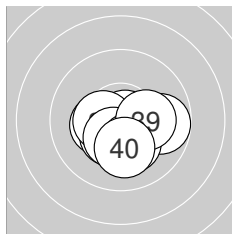

Serie 4: 103.0 (99)

10.3* ←	10.8* →	10.4* ↘	10.4* ↖	9.8 →
10.4* ←	10.4* ↖	10.2* ↘	10.2* →	10.1 ↓

beste Teiler: 33.0 (32.), 130.1 (36.), 139.8 (34.)
Trefferlage: 0.32 mm rechts, 0.75 mm tief
Streuwert: 1.14, horizontal: 1.43, vertikal: 0.74



Ergebnis: 410.8 (392)
Serien: 102.5 102.1 104.6 101.6
Zähler: 32 8 0 0 0 0 0 0 0 0
Innenzehner: 29
Weiteste: 403 (37.), 393 (2.), 359 (17.)
beste Teiler: 35.3 (40.), 41.5 (21.), 56.7 (18.)
Trefferlage: 0.02 mm rechts, 0.26 mm tief
Streuwert: 1.39, horizontal: 1.37, vertikal: 1.42

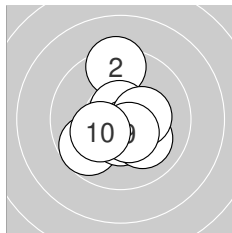
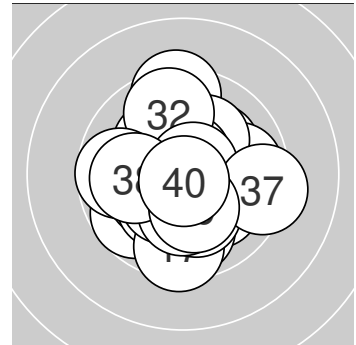

Serie 1: 102.5 (98)

10.5* →	9.4 ↑	10.7* ↑	9.7 ↙	10.6* ↘
10.5* ↓	10.1 ↘	10.3* →	10.5* ↘	10.2* ↙

beste Teiler: 64.4 (3.), 91.4 (5.), 117.3 (9.)
Trefferlage: 0.11 mm rechts, 0.29 mm tief
Streuwert: 1.49, horizontal: 1.29, vertikal: 1.66

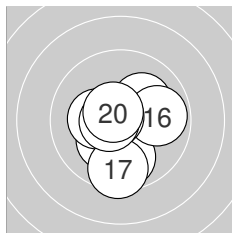

Serie 2: 102.1 (97)

10.2* ↙	10.4* →	10.3* ←	9.8 ↓	10.1 ↗
9.9 →	9.5 ↓	10.7* ↖	10.6* ←	10.6* ↖

beste Teiler: 56.7 (18.), 82.0 (20.), 85.3 (19.)
Trefferlage: 0.10 mm rechts, 0.47 mm tief
Streuwert: 1.49, horizontal: 1.38, vertikal: 1.60

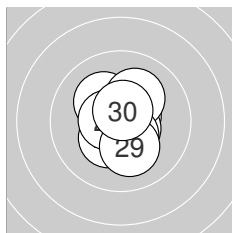

Serie 3: 104.6 (100)

10.8* ←	10.3* ↙	10.6* →	10.6* ↘	10.2* ↖
10.2* ↗	10.5* ↘	10.6* ←	10.2* ↓	10.6* ↑

beste Teiler: 41.5 (21.), 81.5 (30.), 87.2 (23.)
Trefferlage: 0.05 mm rechts, 0.03 mm tief
Streuwert: 1.02, horizontal: 0.85, vertikal: 1.16

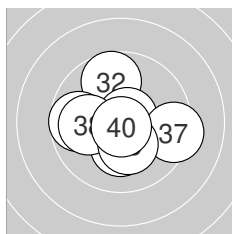

Serie 4: 101.6 (97)

10.5* ←	9.7 ↑	10.7* ↗	9.7 ←	10.2* ↓
10.4* ↘	9.3 →	10.0 ←	10.3* ↓	10.8* ↓

beste Teiler: 35.3 (40.), 59.9 (33.), 124.1 (31.)
Trefferlage: 0.18 mm links, 0.28 mm tief
Streuwert: 1.68, horizontal: 1.94, vertikal: 1.38



Ergebnis: **404.3** (385)
 Serien: 102.3 101.0 98.6 102.4
 Zähler: 26 13 1 0 0 0 0 0 0 0
 Innenzehner: 23
 Weitester: 562 (27.), 402 (24.), 395 (29.)
 beste Teiler: 19.3 (39.), 41.1 (7.), 54.8 (3.)
 Trefferlage: 0.92 mm links, 0.27 mm hoch
 Streuwert: 1.59, horizontal: 1.77, vertikal: 1.39

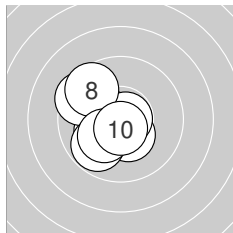
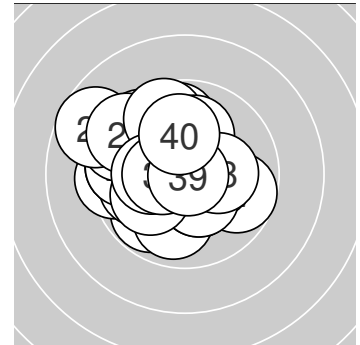

Serie 1: 102.3 (97)

10.5* ←	10.2* ↙	10.7* ↘	10.4* ↓	9.5 ↖
9.8 ↗	10.8* →	9.6 ↘	10.2* ↗	10.6* ↓

beste Teiler: 41.1 (7.), 54.8 (3.), 76.0 (10.)
 Trefferlage: 1.09 mm links, 0.23 mm tief
 Streuwert: 1.34, horizontal: 1.26, vertikal: 1.42

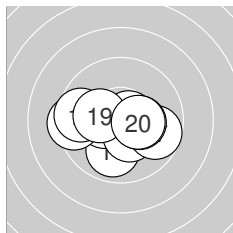

Serie 2: 101.0 (96)

9.9 ↓	10.7* →	10.4* ←	9.4 ←	10.4* ↓
9.6 ←	9.7 ↘	10.3* →	10.2* ←	10.4* →

beste Teiler: 70.2 (12.), 135.4 (13.), 144.9 (15.)
 Trefferlage: 0.36 mm links, 0.44 mm tief
 Streuwert: 1.69, horizontal: 2.21, vertikal: 0.90

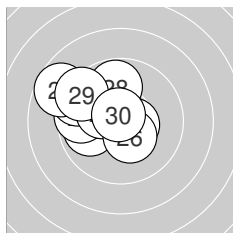

Serie 3: 98.6 (93)

10.5* →	9.9 ←	9.6 ←	9.3 ↖	10.3* ↖
10.4* ↓	8.7 ↖	9.8 ↑	9.4 ↖	10.7* ↑

beste Teiler: 55.9 (30.), 105.3 (21.), 147.3 (26.)
 Trefferlage: 1.80 mm links, 0.90 mm hoch
 Streuwert: 1.76, horizontal: 2.04, vertikal: 1.43

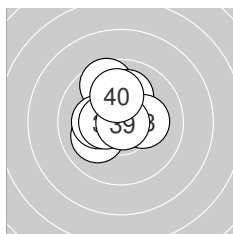

Serie 4: 102.4 (99)

9.6 ↖	10.3* ↑	10.5* ↘	10.1 ↑	10.1 ↙
10.2* ←	10.4* ←	10.2* →	10.9* →	10.1 ↑

beste Teiler: 19.3 (39.), 103.2 (33.), 126.0 (37.)
 Trefferlage: 0.44 mm links, 0.85 mm hoch
 Streuwert: 1.26, horizontal: 1.18, vertikal: 1.33



Ergebnis: 406.0 (390)
Serien: 99.0 100.0 103.6 103.4
Zähler: 30 10 0 0 0 0 0 0 0 0 0
Innenzehner: 23
Weiteste: 445 (10.), 439 (11.), 392 (1.)
beste Teiler: 34.9 (16.), 62.6 (40.), 74.6 (33.)
Trefferlage: 0.49 mm rechts, 0.38 mm hoch
Streuwert: 1.55, horizontal: 1.89, vertikal: 1.12

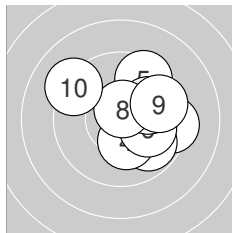
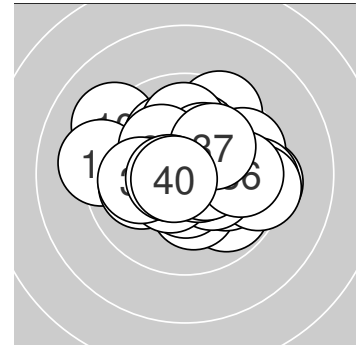

Serie 1: 99.0 (95)

9.4 →	9.8 ↘	10.4* ↗	10.3* ↓	9.5 ↗
10.1 →	10.0 ↗	10.6* ↑	9.7 →	9.2 ↘

beste Teiler: 81.5 (8.), 135.8 (3.), 174.8 (4.)
Trefferlage: 1.30 mm rechts, 0.50 mm hoch
Streuwert: 1.87, horizontal: 2.08, vertikal: 1.65

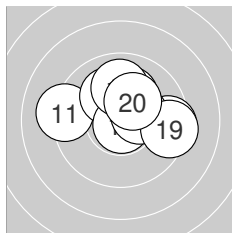

Serie 2: 100.0 (96)

9.2 ←	9.5 →	10.4* ↗	10.1 ↑	10.1 ↘
10.8* ↓	9.9 ↑	10.3* →	9.4 →	10.3* ↗

beste Teiler: 34.9 (16.), 145.7 (13.), 152.8 (18.)
Trefferlage: 0.63 mm rechts, 0.84 mm hoch
Streuwert: 1.82, horizontal: 2.33, vertikal: 1.10

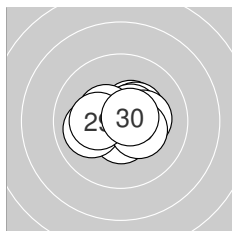

Serie 3: 103.6 (100)

10.5* ↗	10.4* ↗	10.5* ↓	10.5* ↗	10.4* ↘
10.0 ←	10.2* →	10.3* ↘	10.2* ←	10.6* ↗

beste Teiler: 80.6 (30.), 103.0 (24.), 108.1 (23.)
Trefferlage: 0.15 mm rechts, 0.11 mm hoch
Streuwert: 1.10, horizontal: 1.40, vertikal: 0.69

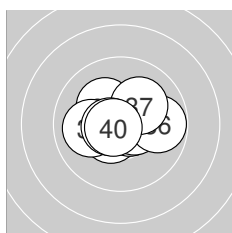

Serie 4: 103.4 (99)

10.5* ↗	10.3* ←	10.7* →	10.5* →	10.2* ↘
9.8 →	10.1 ↗	10.0 ←	10.6* ←	10.7* ↗

beste Teiler: 62.6 (40.), 74.6 (33.), 86.3 (39.)
Trefferlage: 0.11 mm links, 0.08 mm hoch
Streuwert: 1.23, horizontal: 1.58, vertikal: 0.74



Ergebnis: **410.7** (391)
 Serien: 101.9 103.3 101.6 103.9
 Zähler: 31 9 0 0 0 0 0 0 0 0
 Innenzehner: 26
 Weitesten: 466 (23.), 448 (9.), 364 (25.)
 beste Teiler: 27.4 (39.), 28.4 (20.), 43.5 (10.)
 Trefferlage: 0.34 mm links, 0.74 mm hoch
 Streuwert: 1.36, horizontal: 1.39, vertikal: 1.33

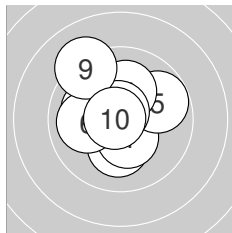
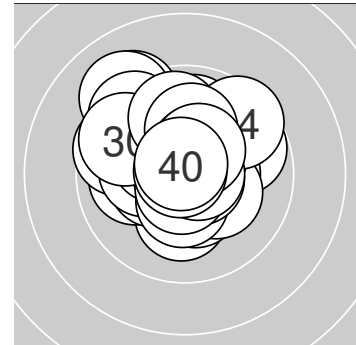

Serie 1: 101.9 (98)

10.6* ↙	10.2* ↓	10.1 ←	10.4* ↓	9.8 →
10.0 ←	10.1 ↑	10.7* ↗	9.2 ↘	10.8* ←

beste Teiler: 43.5 (10.), 57.5 (8.), 86.1 (1.)
 Trefferlage: 0.45 mm links, 0.40 mm hoch
 Streuwert: 1.61, horizontal: 1.57, vertikal: 1.66

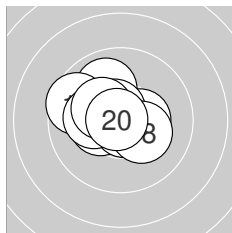

Serie 2: 103.3 (99)

10.4* ←	10.0 ↘	9.6 ←	10.4* →	10.6* ↘
10.7* ↘	10.2* ←	10.3* ↘	10.3* ↘	10.8* ←

beste Teiler: 28.4 (20.), 51.9 (16.), 85.2 (15.)
 Trefferlage: 0.65 mm links, 0.36 mm hoch
 Streuwert: 1.21, horizontal: 1.45, vertikal: 0.91

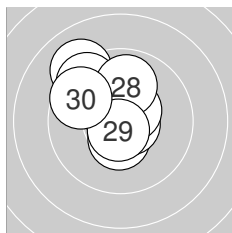

Serie 3: 101.6 (96)

10.7* ↑	10.5* ↘	9.1 ↘	10.4* ↓	9.5 ↘
10.7* →	10.5* ↗	9.9 ↑	10.7* ↓	9.6 ↘

beste Teiler: 54.0 (21.), 65.7 (26.), 66.9 (29.)
 Trefferlage: 0.73 mm links, 1.06 mm hoch
 Streuwert: 1.51, horizontal: 1.43, vertikal: 1.59

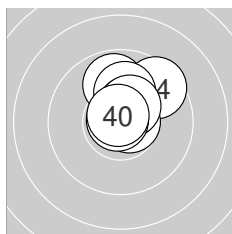

Serie 4: 103.9 (98)

10.5* ↗	9.9 ↑	10.8* ↗	9.5 ↗	10.7* →
10.1 ↑	10.5* ↗	10.4* ↗	10.8* ↘	10.7* ↗

beste Teiler: 27.4 (39.), 45.6 (33.), 52.5 (40.)
 Trefferlage: 0.46 mm rechts, 1.15 mm hoch
 Streuwert: 0.91, horizontal: 0.84, vertikal: 0.97



Ergebnis: **403.4** (388)
 Serien: 100.8 99.9 100.8 101.9
 Zähler: 28 12 0 0 0 0 0 0 0 0
 Innenzehner: 19
 Weitestе: 491 (25.), 432 (38.), 429 (16.)
 beste Teiler: 26.6 (5.), 39.3 (14.), 46.0 (34.)
 Trefferlage: 0.34 mm links, 0.54 mm hoch
 Streuwert: 1.71, horizontal: 1.87, vertikal: 1.53

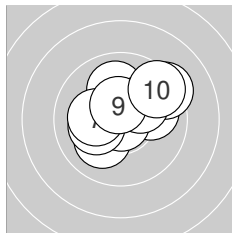
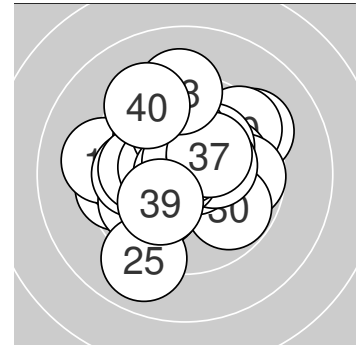

Serie 1: 100.8 (98)

10.0 ↑	10.0 →	9.3 ↗	10.1 ↙	10.8* ↓
10.2* ←	10.2* ←	10.2* ↗	10.5* ↑	9.5 ↗

beste Teiler: 26.6 (5.), 112.4 (9.), 193.0 (8.)
 Trefferlage: 0.44 mm rechts, 0.75 mm hoch
 Streuwert: 1.70, horizontal: 1.99, vertikal: 1.35

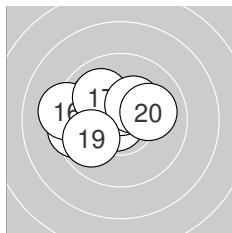

Serie 2: 99.9 (96)

9.5 ←	9.7 ←	10.0 ↘	10.8* ←	10.5* ↑
9.2 ←	10.0 ↘	10.3* ↗	9.9 ←	10.0 →

beste Teiler: 39.3 (14.), 104.0 (15.), 158.5 (18.)
 Trefferlage: 1.36 mm links, 0.48 mm hoch
 Streuwert: 1.63, horizontal: 2.06, vertikal: 1.03

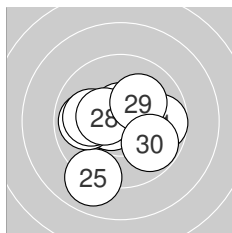

Serie 3: 100.8 (96)

9.7 →	10.6* ←	10.7* ←	10.6* ↑	9.0 ↙
9.9 ←	10.0 ←	10.4* ←	10.1 ↗	9.8 ↘

beste Teiler: 73.2 (23.), 78.1 (24.), 98.0 (22.)
 Trefferlage: 0.33 mm links, 0.34 mm tief
 Streuwert: 1.82, horizontal: 1.98, vertikal: 1.64

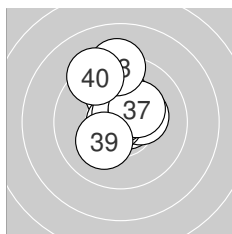

Serie 4: 101.9 (98)

10.1 ↑	10.8* →	10.3* →	10.8* ←	10.2* ↑
10.7* ↑	10.3* ↗	9.2 ↑	10.2* ↙	9.3 ↘

beste Teiler: 46.0 (34.), 50.2 (32.), 64.0 (36.)
 Trefferlage: 0.12 mm links, 1.28 mm hoch
 Streuwert: 1.45, horizontal: 1.07, vertikal: 1.75



Ergebnis: **410.0** (389)
 Serien: 103.4 101.5 100.7 104.4
 Zähler: 29 11 0 0 0 0 0 0 0 0
 Innenzehner: 27
 Weitester: 449 (1.), 436 (40.), 413 (15.)
 beste Teiler: 8.0 (36.), 24.3 (32.), 26.4 (33.)
 Trefferlage: 0.92 mm rechts, 0.70 mm hoch
 Streuwert: 1.26, horizontal: 1.39, vertikal: 1.11

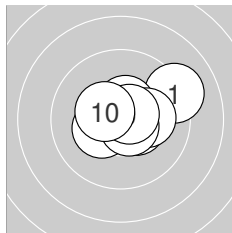
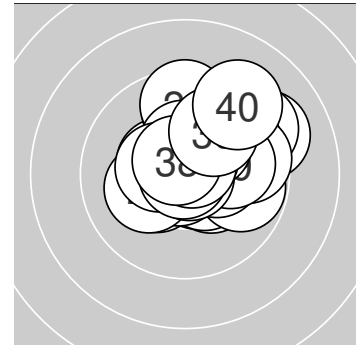

Serie 1: 103.4 (99)

9.2 ↗	10.5* ↘	10.3* ↙	10.3* →	10.8* ↗
10.5* ↑	10.2* →	10.6* ↘	10.6* ↗	10.4* ↘

beste Teiler: 29.0 (5.), 76.1 (9.), 82.4 (8.)
 Trefferlage: 0.79 mm rechts, 0.27 mm hoch
 Streuwert: 1.24, horizontal: 1.56, vertikal: 0.80

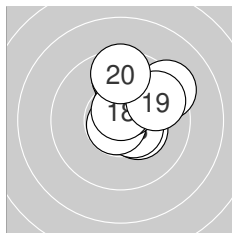

Serie 2: 101.5 (96)

10.4* ↘	9.7 ↑	10.5* ↘	10.8* ↙	9.3 ↗
10.3* ↑	10.5* ↗	10.7* ↑	9.7 ↗	9.6 ↑

beste Teiler: 47.4 (14.), 72.0 (18.), 113.8 (13.)
 Trefferlage: 0.90 mm rechts, 1.19 mm hoch
 Streuwert: 1.37, horizontal: 1.25, vertikal: 1.49

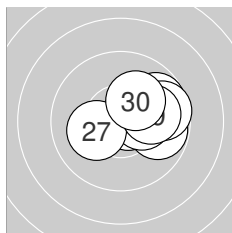

Serie 3: 100.7 (96)

10.7* →	9.9 →	10.1 →	9.8 ↗	9.8 →
10.3* →	10.2* ↙	9.7 →	10.0 →	10.2* ↗

beste Teiler: 57.2 (21.), 161.1 (26.), 191.0 (30.)
 Trefferlage: 1.69 mm rechts, 0.36 mm hoch
 Streuwert: 1.17, horizontal: 1.46, vertikal: 0.77

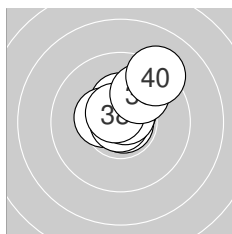

Serie 4: 104.4 (98)

10.6* ↗	10.9* ↘	10.8* ↘	10.4* ↑	10.4* ↙
10.9* ←	10.7* ↗	10.6* ↘	9.9 ↗	9.2 ↗

beste Teiler: 8.0 (36.), 24.3 (32.), 26.4 (33.)
 Trefferlage: 0.31 mm rechts, 0.95 mm hoch
 Streuwert: 1.10, horizontal: 1.07, vertikal: 1.12



Ergebnis: 411.1 (394)
Serien: 103.5 102.9 101.8 102.9
Zähler: 34 6 0 0 0 0 0 0 0 0 0
Innenzehner: 28
Weiteste: 395 (34.), 354 (7.), 342 (18.)
beste Teiler: 24.8 (37.), 31.0 (5.), 32.0 (40.)
Trefferlage: 0.04 mm rechts, 0.44 mm hoch
Streuwert: 1.33, horizontal: 1.59, vertikal: 1.01

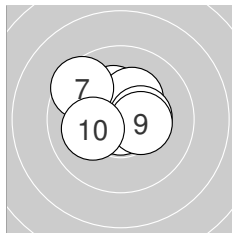
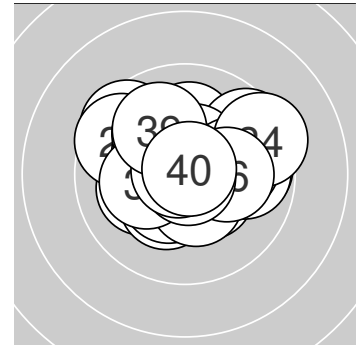

Serie 1: 103.5 (99)

10.8* ←	10.5* ↑	10.4* →	10.3* ↘	10.8* ↓
10.3* ↗	9.5 ↘	10.4* →	10.4* →	10.1 ←

beste Teiler: 31.0 (5.), 38.6 (1.), 105.0 (2.)
Trefferlage: 0.05 mm links, 0.52 mm hoch
Streuwert: 1.23, horizontal: 1.43, vertikal: 0.98

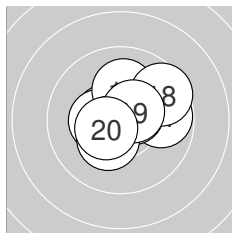

Serie 2: 102.9 (98)

9.8 →	10.5* ↘	10.4* ←	10.6* ↗	10.1 ↑
10.6* ↘	10.3* ↘	9.6 ↗	10.5* ↗	10.5* ↘

beste Teiler: 88.8 (16.), 98.1 (14.), 106.2 (12.)
Trefferlage: 0.26 mm rechts, 0.32 mm hoch
Streuwert: 1.36, horizontal: 1.61, vertikal: 1.06

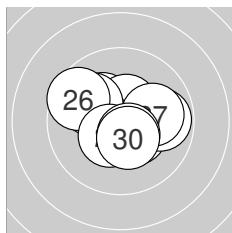

Serie 3: 101.8 (98)

10.4* ↘	10.2* ↘	10.5* ↗	9.8 →	10.0 ↘
9.6 ↘	10.0 →	10.4* ↘	10.5* ↘	10.4* ↘

beste Teiler: 111.1 (29.), 117.3 (23.), 130.0 (28.)
Trefferlage: 0.05 mm rechts, 0.16 mm hoch
Streuwert: 1.52, horizontal: 1.84, vertikal: 1.10

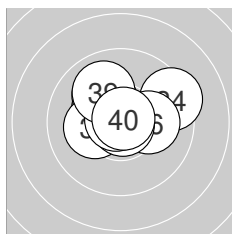

Serie 4: 102.9 (99)

10.3* ↘	10.3* ↘	10.0 ↘	9.4 ↗	10.2* ←
10.2* →	10.9* ↘	10.8* ↘	10.0 ↘	10.8* ↗

beste Teiler: 24.8 (37.), 32.0 (40.), 36.2 (38.)
Trefferlage: 0.08 mm links, 0.79 mm hoch
Streuwert: 1.37, horizontal: 1.69, vertikal: 0.93



Ergebnis: 408.3 (393)
Serien: 101.8 101.9 101.5 103.1
Zähler: 33 7 0 0 0 0 0 0 0 0 0
Innenzehner: 22
Weiteste: 444 (30.), 405 (18.), 403 (10.)
beste Teiler: 49.8 (34.), 52.7 (7.), 62.2 (5.)
Trefferlage: 0.33 mm links, 0.11 mm hoch
Streuwert: 1.48, horizontal: 1.54, vertikal: 1.41

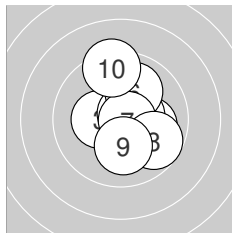
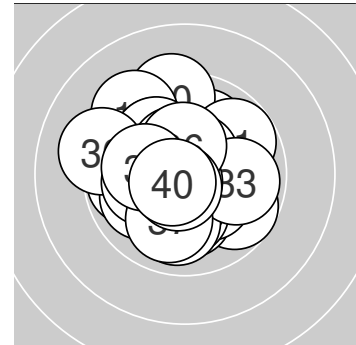

Serie 1: 101.8 (98)

10.4* →	10.1 →	10.3* ←	10.5* →	10.7* ↗
10.0 ↗	10.7* →	9.7 ↘	10.1 ↓	9.3 ↑

beste Teiler: 52.7 (7.), 62.2 (5.), 121.5 (4.)
Trefferlage: 0.70 mm rechts, 0.27 mm hoch
Streuwert: 1.51, horizontal: 1.24, vertikal: 1.74

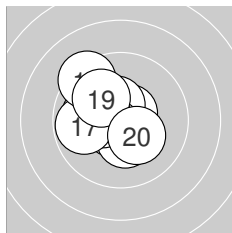

Serie 2: 101.9 (98)

10.6* ↗	10.0 ←	10.5* ↑	10.6* ↖	10.4* ↓
10.4* ←	9.8 ←	9.3 ↘	10.0 ↘	10.3* ↘

beste Teiler: 81.4 (11.), 84.8 (14.), 123.0 (13.)
Trefferlage: 0.93 mm links, 0.33 mm hoch
Streuwert: 1.40, horizontal: 1.42, vertikal: 1.39

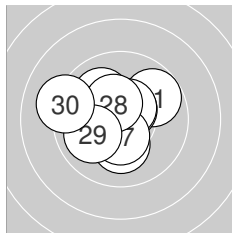

Serie 3: 101.5 (98)

9.8 ↗	10.0 ↘	10.6* ↗	10.4* ↘	10.2* ↓
10.5* ↗	10.4* ↓	10.4* ↘	10.0 ←	9.2 ←

beste Teiler: 94.0 (23.), 103.2 (26.), 130.0 (27.)
Trefferlage: 0.60 mm links, 0.36 mm hoch
Streuwert: 1.60, horizontal: 1.82, vertikal: 1.33

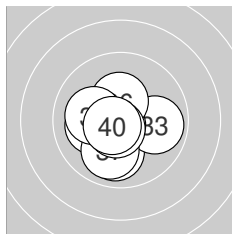

Serie 4: 103.1 (99)

10.0 ↓	10.6* ←	9.9 →	10.8* ↖	10.1 ←
10.4* ↑	10.0 ↓	10.1 ←	10.6* ↖	10.6* ↖

beste Teiler: 49.8 (34.), 76.4 (39.), 77.3 (40.)
Trefferlage: 0.49 mm links, 0.51 mm tief
Streuwert: 1.24, horizontal: 1.30, vertikal: 1.16



Ergebnis: 411.3 (391)
Serien: 103.1 102.7 102.4 103.1
Zähler: 32 7 1 0 0 0 0 0 0 0 0
Innenzehner: 24
Weiteste: 511 (22.), 347 (36.), 330 (23.)
beste Teiler: 24.1 (29.), 25.4 (17.), 46.0 (2.)
Trefferlage: 0.58 mm links, 0.59 mm hoch
Streuwert: 1.28, horizontal: 1.40, vertikal: 1.15

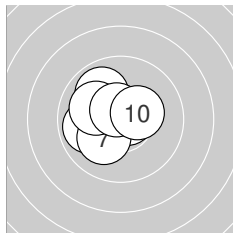
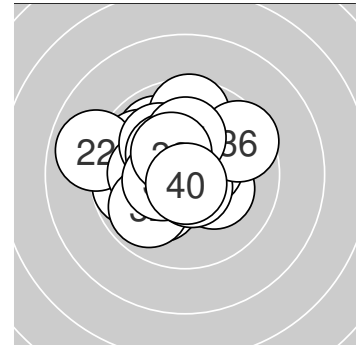

Serie 1: 103.1 (98)

9.9 ↘	10.8* ←	10.7* →	10.2* ↙	10.4* ←
9.9 ←	10.1 ↗	10.1 ↖	10.6* ↘	10.4* ↗

beste Teiler: 46.0 (2.), 55.4 (3.), 84.6 (9.)
Trefferlage: 0.91 mm links, 0.05 mm hoch
Streuwert: 1.15, horizontal: 1.21, vertikal: 1.09

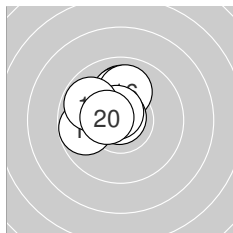

Serie 2: 102.7 (98)

10.0 ↑	10.4* ↗	10.1 ↑	9.8 ←	10.5* ↘
10.0 ↑	10.9* ↗	10.7* ↘	9.8 ↖	10.5* ←

beste Teiler: 25.4 (17.), 72.8 (18.), 116.4 (20.)
Trefferlage: 0.78 mm links, 1.09 mm hoch
Streuwert: 1.05, horizontal: 1.09, vertikal: 1.01

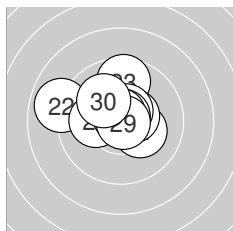

Serie 3: 102.4 (97)

10.2* ↘	8.9 ←	9.6 ↑	10.5* ↗	10.6* ↗
10.1 ←	10.8* ↗	10.7* ↗	10.9* ↗	10.1 ↘

beste Teiler: 24.1 (29.), 46.5 (27.), 53.8 (28.)
Trefferlage: 0.48 mm links, 0.76 mm hoch
Streuwert: 1.56, horizontal: 1.90, vertikal: 1.14

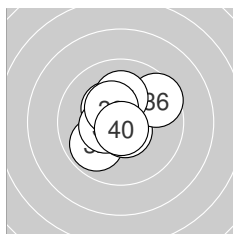

Serie 4: 103.1 (98)

10.4* ↗	9.9 ↗	10.7* ↖	10.3* ↘	10.6* ↘
9.6 ↗	10.1 ↑	10.4* ←	10.4* ↘	10.7* ↓

beste Teiler: 53.4 (40.), 72.0 (33.), 81.0 (35.)
Trefferlage: 0.16 mm links, 0.44 mm hoch
Streuwert: 1.31, horizontal: 1.36, vertikal: 1.26



Ergebnis: 404.7 (383)
Serien: 100.5 100.1 102.1 102.0
Zähler: 24 15 1 0 0 0 0 0 0 0
Innenzehner: 17
Weiteste: 547 (29.), 415 (9.), 408 (12.)
beste Teiler: 4.1 (26.), 20.6 (21.), 35.0 (32.)
Trefferlage: 0.11 mm links, 0.13 mm hoch
Streuwert: 1.72, horizontal: 1.78, vertikal: 1.65

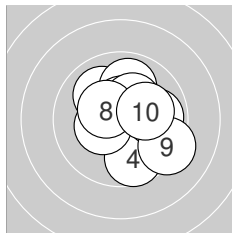
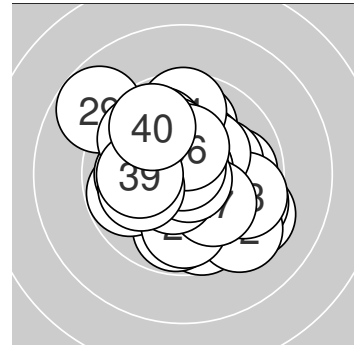

Serie 1: 100.5 (96)

10.0 ↘	9.9 ↑	10.5* ↑	9.7 ↓	10.4* ←
9.9 →	10.3* ↗	10.4* ↖	9.3 ↘	10.1 →

beste Teiler: 112.2 (3.), 135.6 (8.), 146.1 (5.)
Trefferlage: 0.68 mm rechts, 0.28 mm hoch
Streuwert: 1.72, horizontal: 1.72, vertikal: 1.72

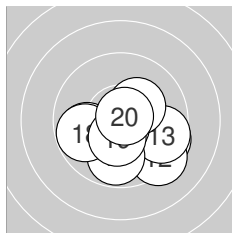

Serie 2: 100.1 (94)

9.5 ↘	9.3 ↘	9.6 →	10.3* ↗	9.9 ←
10.7* ↓	9.8 ↓	9.8 ←	10.4* ↓	10.8* ↗

beste Teiler: 43.8 (20.), 53.0 (16.), 135.7 (19.)
Trefferlage: 0.48 mm rechts, 1.05 mm tief
Streuwert: 1.77, horizontal: 2.19, vertikal: 1.21

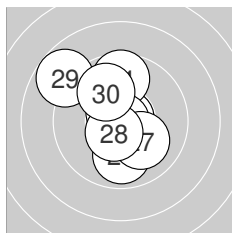

Serie 3: 102.1 (95)

10.9* ←	10.6* ↘	10.8* ↗	9.6 ↑	9.9 ↓
10.9* ↓	10.1 ↘	10.6* ↗	8.8 ↘	9.9 ↖

beste Teiler: 4.1 (26.), 20.6 (21.), 41.6 (23.)
Trefferlage: 0.45 mm links, 0.46 mm hoch
Streuwert: 1.77, horizontal: 1.53, vertikal: 1.98

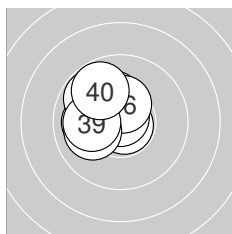

Serie 4: 102.0 (98)

10.8* ↘	10.8* ↑	10.2* ↑	10.0 ←	10.1 ↘
10.4* ↑	9.8 ↘	10.0 ←	10.1 ←	9.8 ↘

beste Teiler: 35.0 (32.), 39.0 (31.), 139.9 (36.)
Trefferlage: 1.19 mm links, 0.84 mm hoch
Streuwert: 1.08, horizontal: 1.08, vertikal: 1.08



Ergebnis: 410.8 (389)
Serien: 104.6 99.7 103.8 102.7
Zähler: 29 11 0 0 0 0 0 0 0 0
Innenzehner: 25
Weiteste: 435 (18.), 409 (31.), 400 (29.)
beste Teiler: 10.0 (36.), 11.6 (8.), 15.1 (27.)
Trefferlage: 0.32 mm links, 0.15 mm tief
Streuwert: 1.47, horizontal: 1.71, vertikal: 1.19

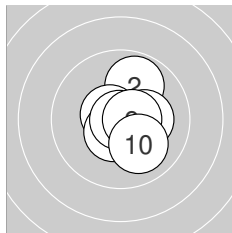
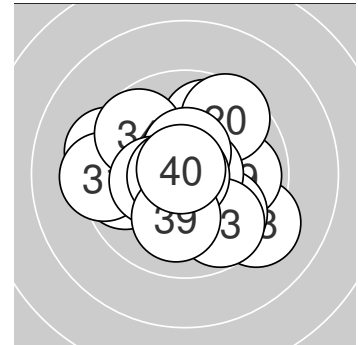

Serie 1: 104.6 (99)

10.8* →	9.9 ↑	10.5* ↓	10.6* ↓	10.6* ↖
10.2* →	10.5* ↙	10.9* ↖	10.6* →	10.0 ↓

beste Teiler: 11.6 (8.), 50.6 (1.), 87.0 (9.)
Trefferlage: 0.46 mm rechts, 0.19 mm tief
Streuwert: 1.02, horizontal: 0.82, vertikal: 1.19

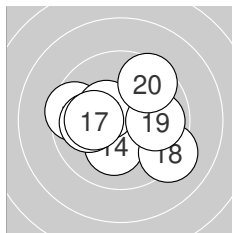

Serie 2: 99.7 (96)

10.3* ←	10.5* ↙	9.5 ←	10.2* ↓	10.4* ↖
10.0 ←	10.1 ←	9.2 ↘	9.9 →	9.6 ↗

beste Teiler: 101.2 (12.), 132.6 (15.), 155.5 (11.)
Trefferlage: 0.32 mm links, 0.11 mm tief
Streuwert: 1.95, horizontal: 2.33, vertikal: 1.47

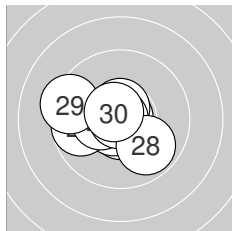

Serie 3: 103.8 (97)

10.6* ↓	10.9* ↗	10.6* ↑	10.7* ↙	9.7 ←
10.4* ←	10.9* ←	9.9 ↘	9.4 ←	10.7* ↖

beste Teiler: 15.1 (27.), 25.2 (22.), 73.5 (24.)
Trefferlage: 0.74 mm links, 0.12 mm tief
Streuwert: 1.33, horizontal: 1.66, vertikal: 0.90

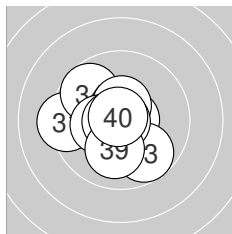

Serie 4: 102.7 (97)

9.3 ←	10.7* →	9.7 ↘	9.7 ↘	10.5* ↑
10.9* ↓	10.3* ←	10.7* ←	10.1 ↓	10.8* ↖

beste Teiler: 10.0 (36.), 32.0 (40.), 68.7 (38.)
Trefferlage: 0.67 mm links, 0.18 mm tief
Streuwert: 1.50, horizontal: 1.65, vertikal: 1.34



Ergebnis: **407.5** (387)
 Serien: 101.0 102.8 101.5 102.2
 Zähler: 27 13 0 0 0 0 0 0 0 0
 Innenzehner: 19
 Weitestе: 401 (24.), 365 (28.), 364 (35.)
 beste Teiler: 16.0 (29.), 21.9 (2.), 50.0 (13.)
 Trefferlage: 0.08 mm rechts, 0.26 mm tief
 Streuwert: 1.56, horizontal: 1.60, vertikal: 1.52

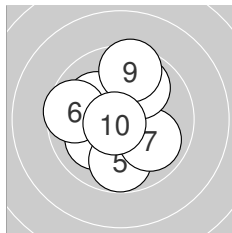
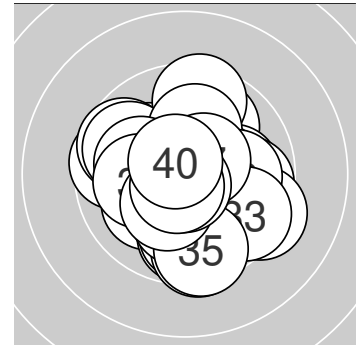

Serie 1: 101.0 (95)

10.1 ↙	10.9* ↖	10.5* ↑	10.1 ↖	9.8 ↓
9.6 ←	9.9 ↘	9.9 ↗	9.5 ↑	10.7* ↙

beste Teiler: 21.9 (2.), 53.2 (10.), 115.1 (3.)
 Trefferlage: 0.32 mm links, 0.26 mm hoch
 Streuwert: 1.74, horizontal: 1.57, vertikal: 1.89

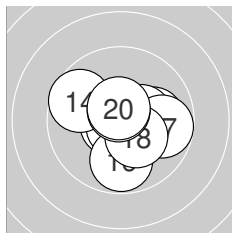

Serie 2: 102.8 (97)

10.7* ↙	10.0 →	10.8* ↘	9.7 ↖	10.4* →
9.8 ↓	9.8 →	10.3* ↘	10.7* ↑	10.6* ↑

beste Teiler: 50.0 (13.), 71.3 (19.), 72.0 (11.)
 Trefferlage: 0.38 mm rechts, 0.18 mm tief
 Streuwert: 1.44, horizontal: 1.66, vertikal: 1.19

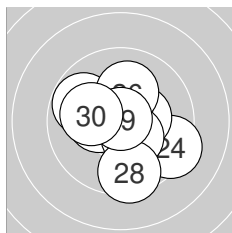

Serie 3: 101.5 (97)

10.7* ←	10.3* ←	9.8 ↖	9.3 ↘	10.4* →
10.1 ↑	10.4* ↘	9.5 ↓	10.9* ↑	10.1 ↖

beste Teiler: 16.0 (29.), 60.4 (21.), 140.0 (27.)
 Trefferlage: 0.00 mm , 0.22 mm tief
 Streuwert: 1.72, horizontal: 1.83, vertikal: 1.60

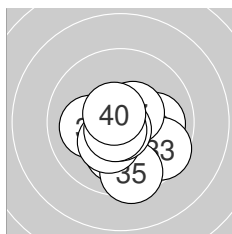

Serie 4: 102.2 (98)

10.1 ↓	10.0 →	9.6 ↘	10.1 ←	9.5 ↓
10.3* ↘	10.5* ↗	10.7* ↓	10.7* ↘	10.7* ↖

beste Teiler: 53.2 (38.), 68.5 (39.), 75.6 (40.)
 Trefferlage: 0.26 mm rechts, 0.92 mm tief
 Streuwert: 1.40, horizontal: 1.49, vertikal: 1.31



Ergebnis: **416.5** (394)
 Serien: 104.1 103.4 104.8 104.2
 Zähler: 34 6 0 0 0 0 0 0 0 0 0
 Innenzehner: 32
 Weitesten: 362 (36.), 333 (5.), 294 (20.)
 beste Teiler: 8.0 (23.), 8.9 (21.), 30.0 (3.)
 Trefferlage: 0.05 mm rechts, 0.10 mm tief
 Streuwert: 1.16, horizontal: 1.33, vertikal: 0.95

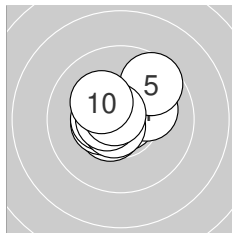
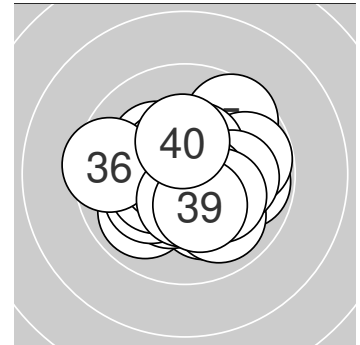

Serie 1: 104.1 (99)

10.5* ↙	10.4* ←	10.8* →	10.2* →	9.6 ↗
10.4* ←	10.7* ↘	10.6* ←	10.7* ↘	10.2* ↘

beste Teiler: 30.0 (3.), 56.8 (9.), 69.3 (7.)
 Trefferlage: 0.22 mm links, 0.32 mm hoch
 Streuwert: 1.14, horizontal: 1.29, vertikal: 0.96

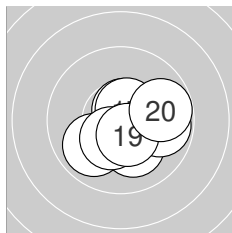

Serie 2: 103.4 (97)

10.7* ↑	9.9 ↘	10.8* →	10.8* ↘	10.1 ↘
9.8 →	10.6* ↗	10.4* ↘	10.5* ↘	9.8 →

beste Teiler: 37.7 (14.), 45.7 (13.), 75.4 (11.)
 Trefferlage: 0.58 mm rechts, 0.43 mm tief
 Streuwert: 1.23, horizontal: 1.42, vertikal: 1.01

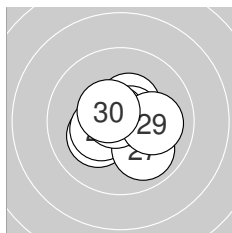

Serie 3: 104.8 (99)

10.9* ↗	10.2* ↙	10.9* →	10.4* ←	10.4* ↗
10.7* →	9.9 ↘	10.8* ↘	10.1 →	10.5* ↘

beste Teiler: 8.0 (23.), 8.9 (21.), 48.2 (28.)
 Trefferlage: 0.10 mm rechts, 0.12 mm tief
 Streuwert: 1.08, horizontal: 1.23, vertikal: 0.90

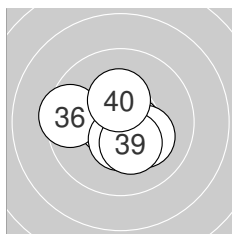

Serie 4: 104.2 (99)

10.8* ↓	10.7* ←	10.6* ↘	10.6* ←	10.7* ↘
9.5 ←	10.5* ↓	10.2* ↘	10.3* ↘	10.3* ↑

beste Teiler: 42.7 (31.), 64.1 (32.), 70.3 (35.)
 Trefferlage: 0.24 mm links, 0.19 mm tief
 Streuwert: 1.18, horizontal: 1.39, vertikal: 0.92



Ergebnis: 408.3 (393)
Serien: 101.8 101.9 101.5 103.1
Zähler: 33 7 0 0 0 0 0 0 0 0 0
Innenzehner: 22
Weiteste: 444 (30.), 405 (18.), 403 (10.)
beste Teiler: 49.8 (34.), 52.7 (7.), 62.2 (5.)
Trefferlage: 0.33 mm links, 0.11 mm hoch
Streuwert: 1.48, horizontal: 1.54, vertikal: 1.41

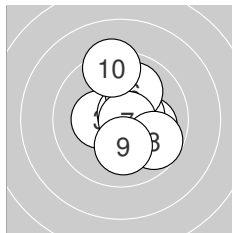
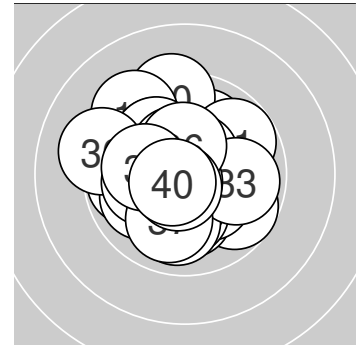

Serie 1: 101.8 (98)

10.4* →	10.1 →	10.3* ←	10.5* →	10.7* ↗
10.0 ↗	10.7* →	9.7 ↘	10.1 ↓	9.3 ↑

beste Teiler: 52.7 (7.), 62.2 (5.), 121.5 (4.)
Trefferlage: 0.70 mm rechts, 0.27 mm hoch
Streuwert: 1.51, horizontal: 1.24, vertikal: 1.74

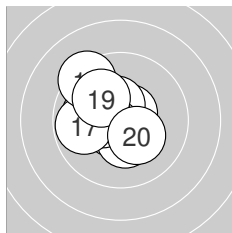

Serie 2: 101.9 (98)

10.6* ↗	10.0 ←	10.5* ↑	10.6* ↖	10.4* ↓
10.4* ←	9.8 ←	9.3 ↘	10.0 ↘	10.3* ↘

beste Teiler: 81.4 (11.), 84.8 (14.), 123.0 (13.)
Trefferlage: 0.93 mm links, 0.33 mm hoch
Streuwert: 1.40, horizontal: 1.42, vertikal: 1.39

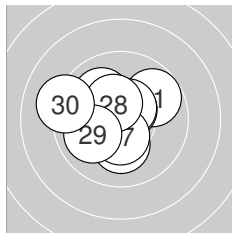

Serie 3: 101.5 (98)

9.8 ↗	10.0 ↘	10.6* ↗	10.4* ↘	10.2* ↓
10.5* ↗	10.4* ↓	10.4* ↘	10.0 ←	9.2 ←

beste Teiler: 94.0 (23.), 103.2 (26.), 130.0 (27.)
Trefferlage: 0.60 mm links, 0.36 mm hoch
Streuwert: 1.60, horizontal: 1.82, vertikal: 1.33

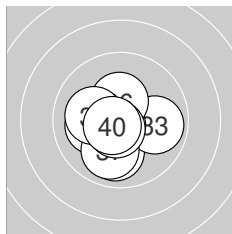

Serie 4: 103.1 (99)

10.0 ↓	10.6* ←	9.9 →	10.8* ↖	10.1 ←
10.4* ↑	10.0 ↓	10.1 ←	10.6* ↖	10.6* ↖

beste Teiler: 49.8 (34.), 76.4 (39.), 77.3 (40.)
Trefferlage: 0.49 mm links, 0.51 mm tief
Streuwert: 1.24, horizontal: 1.30, vertikal: 1.16



Ergebnis: 411.3 (391)
Serien: 103.1 102.7 102.4 103.1
Zähler: 32 7 1 0 0 0 0 0 0 0 0
Innenzehner: 24
Weiteste: 511 (22.), 347 (36.), 330 (23.)
beste Teiler: 24.1 (29.), 25.4 (17.), 46.0 (2.)
Trefferlage: 0.58 mm links, 0.59 mm hoch
Streuwert: 1.28, horizontal: 1.40, vertikal: 1.15

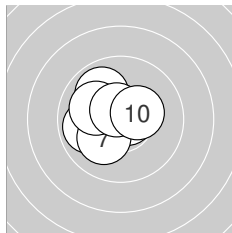
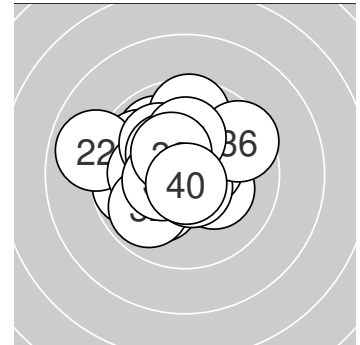

Serie 1: 103.1 (98)

9.9 ↘	10.8* ←	10.7* →	10.2* ↙	10.4* ←
9.9 ←	10.1 ↗	10.1 ↖	10.6* ↘	10.4* ↗

beste Teiler: 46.0 (2.), 55.4 (3.), 84.6 (9.)
Trefferlage: 0.91 mm links, 0.05 mm hoch
Streuwert: 1.15, horizontal: 1.21, vertikal: 1.09

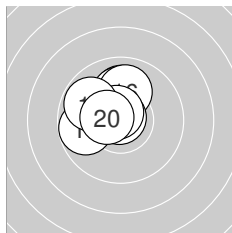

Serie 2: 102.7 (98)

10.0 ↑	10.4* ↗	10.1 ↑	9.8 ←	10.5* ↘
10.0 ↑	10.9* ↗	10.7* ↘	9.8 ↖	10.5* ←

beste Teiler: 25.4 (17.), 72.8 (18.), 116.4 (20.)
Trefferlage: 0.78 mm links, 1.09 mm hoch
Streuwert: 1.05, horizontal: 1.09, vertikal: 1.01

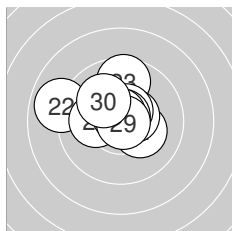

Serie 3: 102.4 (97)

10.2* ↘	8.9 ←	9.6 ↑	10.5* ↗	10.6* ↗
10.1 ←	10.8* ↗	10.7* ↗	10.9* ↗	10.1 ↘

beste Teiler: 24.1 (29.), 46.5 (27.), 53.8 (28.)
Trefferlage: 0.48 mm links, 0.76 mm hoch
Streuwert: 1.56, horizontal: 1.90, vertikal: 1.14

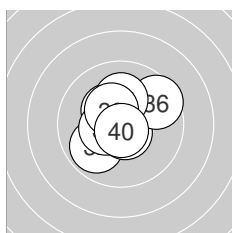

Serie 4: 103.1 (98)

10.4* ↗	9.9 ↗	10.7* ↖	10.3* ↘	10.6* ↘
9.6 ↗	10.1 ↑	10.4* ←	10.4* ↘	10.7* ↓

beste Teiler: 53.4 (40.), 72.0 (33.), 81.0 (35.)
Trefferlage: 0.16 mm links, 0.44 mm hoch
Streuwert: 1.31, horizontal: 1.36, vertikal: 1.26



Ergebnis: 413.4 (395)
Serien: 102.1 103.1 103.6 104.6
Zähler: 35 5 0 0 0 0 0 0 0 0 0
Innenzehner: 27
Weiteste: 370 (29.), 369 (16.), 314 (3.)
beste Teiler: 3.0 (28.), 6.0 (35.), 39.5 (24.)
Trefferlage: 0.50 mm links, 0.09 mm hoch
Streuwert: 1.22, horizontal: 1.35, vertikal: 1.07

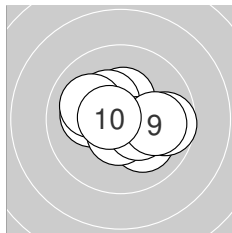
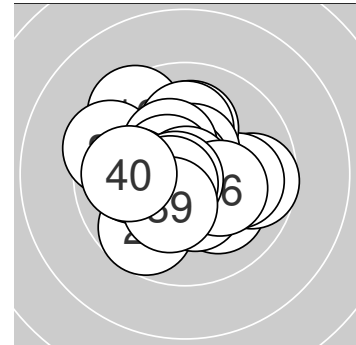

Serie 1: 102.1 (99)

10.1 ↘	10.1 ←	9.7 →	10.4* ↑	10.3* ↘
10.5* ↓	10.4* ↘	10.0 ↖	10.0 →	10.6* ←

beste Teiler: 81.0 (10.), 101.1 (6.), 140.8 (7.)
Trefferlage: 0.26 mm rechts, 0.02 mm hoch
Streuwert: 1.44, horizontal: 1.79, vertikal: 0.96

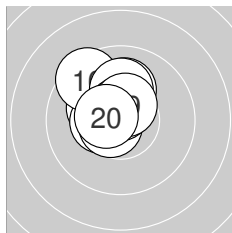

Serie 2: 103.1 (99)

10.6* ←	10.1 ↑	10.2* ↖	10.4* ←	10.6* ↙
9.5 ↘	10.1 ↑	10.6* ↑	10.5* ↑	10.5* ←

beste Teiler: 79.3 (18.), 80.5 (15.), 85.0 (11.)
Trefferlage: 0.72 mm links, 0.96 mm hoch
Streuwert: 0.99, horizontal: 0.88, vertikal: 1.10

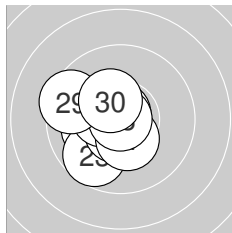

Serie 3: 103.6 (98)

10.1 ←	10.8* ↓	9.7 ↙	10.8* ↑	10.6* ↓
10.4* ←	10.4* ↓	10.9* ←	9.5 ↖	10.4* ↘

beste Teiler: 3.0 (28.), 39.5 (24.), 50.0 (22.)
Trefferlage: 0.92 mm links, 0.27 mm tief
Streuwert: 1.19, horizontal: 1.22, vertikal: 1.17

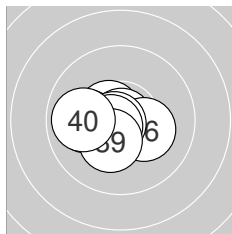

Serie 4: 104.6 (99)

10.6* ↘	10.7* ↓	10.7* ↓	10.0 ←	10.9* →
10.2* ↘	10.7* ↙	10.6* ↙	10.3* ↓	9.9 ←

beste Teiler: 6.0 (35.), 51.0 (37.), 52.8 (33.)
Trefferlage: 0.61 mm links, 0.33 mm tief
Streuwert: 0.94, horizontal: 1.22, vertikal: 0.53

